



Proceedings of the 1st International Conference on Algebras, Graphs and Ordered Sets (ALGOS 2020)

Miguel Couceiro, Pierre Monnin, Amedeo Napoli

► **To cite this version:**

Miguel Couceiro, Pierre Monnin, Amedeo Napoli. Proceedings of the 1st International Conference on Algebras, Graphs and Ordered Sets (ALGOS 2020). Miguel Couceiro; Pierre Monnin; Amedeo Napoli. 1st International Conference on Algebras, Graphs and Ordered Sets (ALGOS 2020), Aug 2020, Nancy, France. 2020, Proceedings of the 1st International Conference on Algebras, Graphs and Ordered Sets (ALGOS 2020). hal-02918958

HAL Id: hal-02918958

<https://hal.archives-ouvertes.fr/hal-02918958>

Submitted on 21 Aug 2020

HAL is a multi-disciplinary open access archive for the deposit and dissemination of scientific research documents, whether they are published or not. The documents may come from teaching and research institutions in France or abroad, or from public or private research centers.

L'archive ouverte pluridisciplinaire **HAL**, est destinée au dépôt et à la diffusion de documents scientifiques de niveau recherche, publiés ou non, émanant des établissements d'enseignement et de recherche français ou étrangers, des laboratoires publics ou privés.

Proceedings

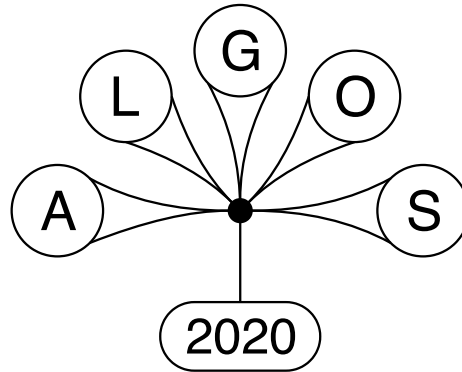

First International Conference
“Algebras, graphs and ordered sets”
ALGOS 2020

August 26–28, 2020

Nancy, France

Editors

Miguel Couceiro (Loria)

Pierre Monnin (Loria)

Amedeo Napoli (Loria)

<https://algos2020.loria.fr/>

Preface

Originating in arithmetics and logic, the theory of ordered sets is now a field of combinatorics that is intimately linked to graph theory, universal algebra and multiple-valued logic, and that has a wide range of classical applications such as formal calculus, classification, decision aid and social choice.

This international conference “Algebras, graphs and ordered set” (ALGOS) brings together specialists in the theory of graphs, relational structures and ordered sets, topics that are omnipresent in artificial intelligence and in knowledge discovery, and with concrete applications in biomedical sciences, security, social networks and e-learning systems. One of the goals of this event is to provide a common ground for mathematicians and computer scientists to meet, to present their latest results, and to discuss original applications in related scientific fields. On this basis, we hope for fruitful exchanges that can motivate multidisciplinary projects.

The first edition of *Algebras, Graphs and Ordered Sets (ALGOS 2020)* has a particular motivation, namely, an opportunity to honour Maurice Pouzet on his 75th birthday! For this reason, we have particularly welcomed submissions in areas related to Maurice’s many scientific interests:

- Lattices and ordered sets
- Combinatorics and graph theory
- Set theory and theory of relations
- Universal algebra and multiple valued logic
- Applications: formal calculus, knowledge discovery, biomedical sciences, decision aid and social choice, security, social networks, web semantics...

The many submissions were subject to a strict reviewing process that resulted in the selection of 27 contributions. ALGOS 2020 includes regular sessions (extended abstracts, short and long papers) and special sessions (dedicated and open problems). Furthermore, it also features 12 plenary contributions.

ALGOS 2020 was originally planned to take place on August 26 (Wednesday), 27 (Thursday), 28 (Friday) of 2020, at the Lorraine Research Laboratory in Computer Science and its Applications (LORIA, UMR 7503). However, due to the covid-19 pandemic, we were forced to move it fully online...We are truly thankful to IRISA (“Institut de Recherche en Informatique et Systèmes Aléatoires”) for providing the access to an instance of platform Big Blue Button for hosting our online event.

On behalf of the organising committee we also wish to express our deepest gratitude to all members of the scientific committee and to all colleagues and friends of Maurice Pouzet, that contributed to the reviewing process, to the scientific content to honour Maurice, and that agreed to participate in this non physical form.

Miguel Couceiro
Pierre Monnin
Amedeo Napoli

Organizing Committee

Nathalie Bussy (Loria)
Miguel Couceiro (General chair, Loria)
Lucien Haddad (RMC, CA)
Jean-Yves Marion (Loria)
Pierre Monnin (Loria)
Amedeo Napoli (Loria)
Lauréline Nevin (Loria)
Justine Reynaud (Loria)
Michael Rusinowich (Loria)
Hamza Si Kaddour (U. Lyon)

Scientific Committee

Kira Adaricheva (Hofstra U., USA)
Ron Aharoni (Technion, Haifa, IL)
Jorge Almeida (U. Porto, PT)
Karell Bertet (U. Rochelle, FR)
Guillaume Bonfante (U. Lorraine, Loria, FR)
Robert Bonnet (U. Savoie, FR)
Moncef Bouaziz (King Saud U., SA)
Imed Boudabbous (U. Sfax, TN)
Youssef Boudabbous (King Saud U., SA)
Pierre Charbit (U. Paris 7, IRIF, FR)
Christian Delhommé (U. Réunion, FR)
Jimmy Devillet (U. Luxembourg, LU)
Dwight Duffus (Emory U., USA)
Mirna Dzamonja (U. East Anglia, UK)
Stephan Foldes (U. Miskolc, HU)
Michel Grabisch (U. Paris I, FR)

Jens Gustedt (Inria, FR)
Frederic Havet (I3S, CNRS/UNSA-INRIA)
Mustapha Kabil (U. Hassan II de Casablanca, MA)
Benoit Larose (Lacim UQAM, CA)
Erkko Lehtonen (U. Nova Lisboa, PT)
Jean-Luc Marichal (U. Luxembourg, LU)
Gerasimos Meletiou (U. Ioannina, GR)
Djamila Oudrar (U.S.T.H.B., DZ)
Maurice Pouzet (U. Lyon & U. Calgary, FR & CA)
Fatiha Saïs (U. Paris Sud, FR)
Luigi Santocanale (U. Aix-Marseille, FR)
Jean-Sébastien Sereni (CNRS, FR)
Nicolas Thiery (U. Paris Sud, FR)
Nicolas Trotignon (ENS Lyon, FR)
Tamás Waldhauser (U. Szeged, HU)
Fred Wehrung (CNRS, FR)
Robert Woodrow (U. Calgary, CA)
Imed Zaguia (RMC, CA)
Nejib Zaguia (U. Ottawa, CA)

Table of Contents

Preface	3
Extended abstracts	11
<i>Some remarks on Skula spaces</i>	
Robert Bonnet	13
<i>Permanent and determinant of Toeplitz-Hessenberg matrices with generalized Fibonacci and Lucas entries</i>	
Ihab Eddine Djellas, Hacène Belbachir, and Amine Belkhir	15
<i>Integer sequences and ellipse chains inside a hyperbola</i>	
Soumeya M. Tebtoub, Hacène Belbachir, and László Németh	17
<i>Bi^snomial coefficients and s-Lah numbers</i>	
Imène Touaibia, Hacène Belbachir, and Miloud Mihoubi	19
<i>On generalization of bi-periodic r-numbers</i>	
N. Rosa Ait-Amrane	21
<i>From ternary abstract cosets to groups and from medians to semilattices via base-points: comments on analogies</i>	
Stephan Foldes and Gerasimos Meletiou	23
<i>On the enumeration of p-oligomorphic groups</i>	
Justine Falque	25
<i>Log-concavity and unimodality in arithmetical triangles</i>	
Assia F. Tebtoub	27
Short papers	29
<i>Decomposition schemes for symmetric n-ary bands</i>	
Jimmy Devillet and Pierre Mathonet	31
<i>Linearly definable classes of Boolean functions</i>	
Miguel Couceiro and Erkko Lehtonen	39
<i>Combinatorial interpretation of bi^snomial coefficients and generalized Catalan numbers</i>	
Hacène Belbachir and Oussama Igueroufa	47
<i>Graphs containing finite induced paths of unbounded length</i>	
Maurice Pouzet and Imed Zaguia	55
<i>Monotonic computation rules for nonassociative calculus</i>	
Miguel Couceiro and Michel Grabisch	59
<i>Structures with no finite monomorphic decomposition: application to the profile of hereditary classes</i>	
Djamila Oudrar and Maurice Pouzet	67
<i>A note on the Boolean dimension of a graph and other related parameters</i>	
Maurice Pouzet, Hamza Si Kaddour, and Bhalchandra D. Thatte	73

Long papers	79
<i>Bijjective proofs for Eulerian numbers in types B and D</i> Luigi Santocanale	81
<i>Polymorphism-homogeneity and universal algebraic geometry</i> Endre Tóth and Tamás Waldhauser	95
<i>Termination of graph rewriting systems through language theory</i> Guillaume Bonfante and Miguel Couceiro	105
<i>Inversion number of an oriented graph and related parameters</i> Jørgen Bang-Jensen, Jonas Costa Ferreira da Silva, and Frédéric Havet	119
<i>Tackling scalability issues in mining path patterns from knowledge graphs: a preliminary study</i> Pierre Monnin, Emmanuel Bresso, Miguel Couceiro, Malika Smaïl-Tabbone, Amedeo Napoli, and Adrien Coulet	141
<i>(-k)-critical trees and k-minimal trees</i> Walid Marweni	157
<i>Unstable graphs and packing into fifth power</i> Mohamed Y. Sayar, Tarak Louleb, and Mohammad Alzohairi	167
Special sessions	179
<i>Reconstruction of digraphs up to complementation</i> Aymen Ben Amira, Jamel Dammak, and Hamza Si Kaddour	181
<i>Big Ramsey degrees of the universal homogeneous partial order are finite</i> Jan Hubička	183
<i>Well quasi ordering and embeddability of relational structures</i> Maurice Pouzet	185
<i>On relational structures with polynomial profile</i> Nicolas M. Thiéry	189
<i>Recursive construction of the minimal prime digraphs</i> Mohammad Alzohairi, Moncef Bouaziz, and Youssef Boudabbous	191
Abstract of the invited talks	193
<i>The colorful world of rainbow sets</i> Ron Aharoni	195
<i>F_3-reconstruction</i> Youssef Boudabbous and Christian Delhommé	197
<i>Extremal problems for boolean lattices and their quotients</i> Dwight Duffus	199
<i>On logics that make a bridge from the discrete to the continuous</i> Mirna Džamonja	201
<i>Graph searches and maximal cliques structure for cocomparability graphs</i> Michel Habib	203

<i>Ordering infinities</i>	
Joris van der Hoeven	207
<i>Maurice's siblings</i>	
Claude Laflamme	211
<i>Applications of order trees in infinite graphs</i>	
Max Pitz	213
<i>Synchronous programming of real-time systems or turning mathematics into trustable code</i>	
Marc Pouzet	215
<i>Partitioning subgroups of the symmetric group $\mathfrak{S}(U)$</i>	
Norbert Sauer	217
<i>Twin-width</i>	
Stéphan Thomassé	219
<i>(TBA)</i>	
Jaroslav Nešetřil	221

Extended abstracts

SOME REMARKS ON SKULA SPACES

Robert Bonnet

Laboratoire de Mathématiques (U.M.R. 5127, C.N.R.S.)

Université de Savoie-Mont Blanc

Bâtiment Le Chablais, Campus Scientifique,

F- 73376, Le Bourget du Lac CEDEX, France

<https://www.lama.univ-smb.fr/pagesmembres/bonnet/>

Robert.Bonnet@univ-smb.fr

This lecture is a survey of a joint work with Taras Banach and Wiesław Kubiś entitled

VIETORIS HYPERSPACES OF SCATTERED PRIESTLEY SPACES [2]: <http://arxiv.org/abs/2007.12890>

This paper is the continuous of the work well-generated Boolean algebras, in a topological way, started in [3].

Stone duality. If X is a compact and 0-dimensional space then the set $\text{Clop}(X)$ of closed and open (clopen) subsets of X is a Boolean algebra generating the topology of X . Conversely any Boolean algebra B is the algebra of clopen subsets of the compact and 0-dimensional space $\text{Ult}(B) \subseteq \{0, 1\}^B$. By duality, we have the following result.

Theorem 1. (§2.3 in [3]) *The space $\text{Ult}(B)$ of a Boolean algebra B is Skula if and only if B is well-generated. That is, by the definition: B has a well-founded sublattice generating B .* □

1. Skula spaces.

For a topological space X , we say that a family $\mathcal{U} := \{U_x : x \in X\}$ is a **clopen selector** if each U_x is a closed and open (clopen) subset of X and if \mathcal{U} satisfies:

- (1) $x \in U_x$ for every $x \in X$ and
- (2) the relation “ $x <^{\mathcal{U}} y$ if and only if $x \neq y$ and $x \in U_y$ ” is irreflexive and transitive. ■

Therefore a clopen selector $\mathcal{U} := \{U_x : x \in X\}$ for X induces a partial order relation $\leq^{\mathcal{U}}$ on X , defined by

$$x \leq^{\mathcal{U}} y \quad \text{if and only if} \quad U_x \subseteq U_y.$$

Hence $U_x := \{y \in X : y \leq^{\mathcal{U}} x\}$ (also denoted by $\downarrow x$) is a clopen principal ideal of X for any $x \in X$ for the order $\leq^{\mathcal{U}}$.

Remark. The set of U_x 's and their complements generate the topology whenever X is compact. ■

A space X is **Skula** if X is a Hausdorff compact space and has a clopen selector. ■

Theorem 2. [2] *Let $\mathcal{U} := \{U_x : x \in X\}$ be a clopen selector for a Skula space X . Then*

- *Every (nonempty) closed initial subset of X is a finite union of U_z 's (notice that X and the U_t 's are compact clopen sets).
In particular for distinct U_x and U_y in \mathcal{U} , $U_x \cap U_y$ is a finite union of U_z 's.*
- (1) *$\langle \mathcal{U}, \subseteq \rangle$ is well-founded. Therefore $\langle X, \subseteq \rangle$ has a well-founded rank: $\text{rk}_{\text{WF}_X}(x) = \sup\{\text{rk}_{\text{WF}_X}(y) : y < x\}$. So $\text{rk}_{\text{WF}_X}(x) = 0$ if and only if x is minimal, i.e. $U_x = \{x\}$. Moreover $\text{rk}_{\text{WF}}(X) := \sup_{x \in X} \text{rk}_{\text{WF}_X}(x)$.*
- (2) *X is scattered, i.e. every nonempty subset of $\text{Ult}(B)$ has an isolated point (for the induced topology). Therefore we can define the Cantor-Bendixson height (ht_{CB_X}) of $x \in X$. For instance $\text{ht}_{\text{CB}_X}(x) = 0$ if and only if x is isolated in X . Moreover $\text{ht}_{\text{CB}}(X) := \sup_{x \in X} \text{ht}_{\text{CB}_X}(x)$.* □

Since $U_x = \downarrow x := \{y \in X : y \leq x\}$ is an initial and clopen subset of X , we have $\text{ht}_{\text{CB}}(U_x) = \text{ht}_{\text{CB}_X}(x) \leq \text{rk}_{\text{WF}_X}(x) = \text{rk}_{\text{WF}}(U_x)$ for any $x \in X$, and so $\text{ht}_{\text{CB}}(X) \leq \text{rk}_{\text{WF}}(X)$.

To a Skula space X we can associate its Vietoris hyperspace $H(X)$, that is a “free join-semilattice over X in the category of continuous join semilattice spaces”.

We define the **Vietoris hyperspace** $H(X)$ over X as follows:

- $H(X)$ is the set of all nonempty closed initial subsets of $\langle X, \leq \rangle$.
- For $F, G \in H(X)$, we set $F \leq G$ if and only if $F \subseteq G$.
- The topology τ on $H(X)$ is the topology generated by the sets

$$U^+ := \{K \in H(X) : K \subseteq U\} \quad \text{and} \quad V^- := \{K \in H(X) : K \cap V \neq \emptyset\}$$
 where U and V are any clopen initial subsets and clopen final subsets in X , respectively. ■

Theorem 3. [2] *Let X be a Skula space. Then $H(X)$ is a Skula space and*

- $\langle A, B \rangle \mapsto A \vee B := A \cup B$ is a continuous semilattice operation on $H(X)$.
- X is topologically embeddable in $H(X)$ by the increasing continuous map $\eta : x \mapsto \downarrow x := U_x$.
- The join semilattice generated by $\eta[X]$ in $H(X)$ is topologically dense in $H(X)$. □

Theorem 4. [2] *Let X be a Skula space and let \mathcal{U} be a clopen selector for X . Then*

$$\text{ht}_{\text{CB}}(X) \leq \text{rk}_{\text{WF}}(X) < \omega^{\text{ht}_{\text{CB}}(X)+1} \quad \text{and} \quad \text{rk}_{\text{WF}}(H(X)) \leq \omega^{\text{rk}_{\text{WF}}(X)}.$$
 □

2. Canonical Skula spaces.

A space X is a **canonical Skula space** if X has a clopen selector $\mathcal{U} := \{U_x : x \in X\}$ satisfying one of the following equivalent properties for each $U_x \in \mathcal{U}$:

- (i) There is an ordinal α such that the α^{th} -Cantor-Bendixson derivative $D^\alpha(U_x)$ of U_x is the singleton $\{x\}$.
- (ii) $\text{rk}_{\text{WF}}(U_x) = \text{ht}_{\text{CB}}(U_x)$ and U_x is unitary (meaning that $D^\beta(U_x)$ is a singleton for some β). ■

Examples. Every continuous image of a compact ordinal space $\alpha + 1$ (with the order topology) is canonically Skula. The class of canonically Skula spaces is closed under finite product.

Theorem 5. [2] *Let X be a canonical Skula space. Then $H(X)$ is a canonical Skula space.* □

Moreover we can compute $\text{ht}_{\text{CB}_{H(X)}}(V) = \text{rk}_{\text{WF}_{H(X)}}(V)$ for every $V \in H(X)$.

Remark. (1) There is a compact and 0-dimensional space which is not Skula [3].
 (2) There is a Skula space which is not canonically Skula [3].

3. Poset spaces.

For a partially ordered set (poset) P we denote by $\text{IS}(P)$ the set of initial subsets of P endowed with the pointwise topology. So $\text{IS}(P)$, as compact subspace of $\{0, 1\}^P$, is compact and 0-dimensional, and we can see $H(P) := \text{IS}(P)$ as the “Vietoris hyperspace” of the poset P .

Proposition 6. [1, Theorems 1.3] *Let P be a poset. The space $\text{IS}(P)$ is Skula if and only if*

- (1) P is a narrow, i.e. any antichain is finite, and
- (2) P is order-scattered, i.e. does not contains a copy of the rationals chain \mathbb{Q} . □

Recall that a well-quasi ordering (wqo) is a narrow and well-founded poset. From the above result, M. Pouzet asks for the following question.

Question (M. Pouzet). Let P be a well-quasi ordering. Is $\text{IS}(P)$ canonically Skula?

We do not know the answer of this question even if P is covered by finitely many well-orderings.

References

- [1] U. Abraham, R. Bonnet, W. Kubiś, M. Rubin: *On poset Boolean algebras*, Order **20**, (2003), 265–290. 2
- [2] Taras Banach, Robert Bonnet, Wiesław Kubiś: *Vietoris hyperspaces of scattered Priestley spaces*. in <http://arxiv.org/abs/2007.12890>. 1, 2
- [3] R. Bonnet, M. Rubin: *On well-generated Boolean algebras*, Ann. Pure Appl. Logic **105** (2000), 1–50. 1, 2

PERMANENT AND DETERMINANT OF TOEPLITZ-HESSENBERG MATRICES WITH GENERALIZED FIBONACCI AND LUCAS ENTRIES

Ihab Eddine Djellas

USTHB, Faculty of Mathematics,
RECITS Laboratory,
P. Box 32, El Alia, 16111, Bab Ezzouar, Algiers, Algeria
ihbusthb@gmail.com

Hacène Belbachir

USTHB, Faculty of Mathematics,
RECITS Laboratory,
P. Box 32, El Alia, 16111, Bab Ezzouar, Algiers, Algeria
hacenebelbachir@gmail.com

Amine Belkhir

USTHB, Faculty of Mathematics,
RECITS Laboratory,
P. Box 32, El Alia, 16111, Bab Ezzouar, Algiers, Algeria
ambelkhir@gmail.com

ABSTRACT

In this work we give formulas for the permanent and determinant of some families of Toeplitz–Hessenberg matrices having generalized Fibonacci numbers and generalized Lucas numbers as entries and so we generalize some previous results. Then, using the structure of the matrix we derive new identities involving sums of products of generalized Fibonacci numbers and generalized Lucas numbers with multinomial coefficients. Finally we give an application of the determinant of such matrices.

Keywords Generalized Fibonacci numbers · generalized Lucas numbers · Toeplitz-Hessenberg permanent · Toeplitz-Hessenberg determinant.

1 Introduction

Let $p, q \in \mathbb{Z}$. The generalized Fibonacci sequence, "denoted U_n ", is defined by $U_0 = 0$, $U_1 = 1$, and the following recurrence relation

$$U_n = pU_{n-1} + qU_{n-2}, \quad (1)$$

The generalized Lucas sequence, "denoted (V_n) ", is defined by $V_0 = 2$, $V_1 = p$, and the recurrence relation

$$V_n = pV_{n-1} + qV_{n-2}. \quad (2)$$

Let $A = (a_{ij})$ be an $n \times n$ matrix. The permanent of A, written $Per(A)$ was introduced in the 1800s, and is defined by

$$Per(A) = \sum_{\sigma} \prod_{i=1}^n a_{i\sigma(i)},$$

where the summation extends over all elements σ of the symmetric group S_n .

A lower Toeplitz–Hessenberg matrix is a square matrix of the form

$$M_n(a_0, a_1, \dots, a_n) = \begin{pmatrix} a_1 & a_0 & 0 & \cdots & 0 & 0 \\ a_2 & a_1 & a_0 & \cdots & 0 & 0 \\ \cdots & \cdots & \cdots & \ddots & \cdots & \cdots \\ a_{n-1} & a_{n-2} & a_{n-3} & \cdots & a_1 & a_0 \\ a_n & a_{n-1} & a_{n-2} & \cdots & a_2 & a_1 \end{pmatrix}, \quad (3)$$

where $a_0 \neq 0$ and $a_k \neq 0$ for at least one $k > 0$.

2 Main results

In this work we generalize the results of [2]. We give formulas for the permanent and determinant of matrices defined as (3) with generalized Fibonacci numbers and generalized Lucas numbers as entries. First we give the formulas of the permanent:

$$PerM_n(1, U_{as+b}, U_{a(s+1)+b}, \dots, U_{a(s+n-1)+b}),$$

and,

$$PerM_n(1, V_{as+b}, V_{a(s+1)+b}, \dots, V_{a(s+n-1)+b}).$$

And also the formulas of the determinant,

$$DetM_n(1, U_{as+b}, U_{a(s+1)+b}, \dots, U_{a(s+n-1)+b}),$$

and,

$$DetM_n(1, V_{as+b}, V_{a(s+1)+b}, \dots, V_{a(s+n-1)+b}).$$

For any $n, s, a \geq 1$ and $0 \leq b < a$.

Next, we provide new identities for generalized Fibonacci and Lucas numbers using a combination of Trudi's formula, see [4]; and the results already found for the permanent and determinant.

We conclude our work by using the determinant of the Toeplitz-Hessenberg matrices with generalized Fibonacci entries to give the n^{th} term of the recurrence sequence $(w_m)_{m > -n}$ defined as follow,

$$\begin{cases} w_{-j} = 0 & \text{for } 1 \leq j \leq n-1, \\ w_0 = 1, \\ w_m = -U_{as+b}w_{m-1} - U_{a(s+1)+b}w_{m-2} - \cdots - U_{a(s+n-1)+b}w_{m-n} \end{cases}$$

Also similar results for generalized Lucas, usual Fibonacci and usual Lucas were established.

References

- [1] H. Belbachir and F. Bencherif. Sums of products of generalized Fibonacci and Lucas numbers. *arXiv preprint arXiv:0708.2347*. 2007.
- [2] T. Goy and M. Shattuck. Fibonacci and Lucas Identities from Toeplitz–Hessenberg Matrices. *Applications and Applied Mathematics*, **14(2)** 2019.
- [3] H. Minc. Permanents. *Cambridge University Press*. (Vol. 6) 1984.
- [4] T. Muir. The Theory of Determinants in the Historical Order of Development: Volume One: General and Special Determinants Up to 1841. Volume Two: The Period 1841 to 1860. *Dover Publications*. 1960.

INTEGER SEQUENCES AND ELLIPSE CHAINS INSIDE A HYPERBOLA

Soumeya M. Tebtoub

Department of Mathematics

RECITS Laboratory

USTHB, Algiers, Algeria

stebtoub@usthb.dz or tebtoub soumeya@gmail.com

Hacène. Belbachir

Department of Mathematics

RECITS Laboratory

USTHB, Algiers, Algeria

hbelbachir@usthb.dz or hacenebelbachir@gmail.com

László. Németh

Institute of Mathematics

University of Sopron

Sopron, Hungary

and associate member of RECITS Laboratory, USTHB

nemeth.laszlo@uni-sopron.hu

ABSTRACT

We propose an extension to the work of Lucca [Giovanni Lucca, Integer sequences and circle chains inside a hyperbola, *Forum Geometricorum*, Volume 19. 2019, 11–16.]. Our goal is to examine chains of ellipses inside (outside) the branch of hyperbola, and we derive recurrence relations of centers and minor (major) axes of the ellipse chains. As well as to determine conditions for these recurrence sequences that consist of integer numbers.

Keywords Ellipse chains · Circle chains · Hyperbola · Integer sequences.

1 Introduction

Let us consider the hyperbola \mathcal{H} with the canonical equation

$$\frac{x^2}{a^2} - \frac{y^2}{b^2} = 1, \quad (1)$$

and foci $(\pm c, 0)$, where a and b are positive real numbers and $c^2 = a^2 + b^2$. Lucca [1] examined a tangential chain of circles inside the branch $x > 0$ of the hyperbola so that the i -th circle with center $(x_i, 0)$ and radius r_i is tangent to the hyperbola and to the preceding and succeeding circles labelled by indexes $i - 1$ and $i + 1$, respectively. He showed that in case of certain ratios $\frac{b}{a}$ the sequences $\{\frac{x_i}{x_0}\}_{i=0}^{\infty}$ and $\{\frac{r_i}{r_0}\}_{i=0}^{\infty}$ are integers.

The objective of this paper is to extend Lucca's work, therefore, we are able to provide more integer sequences.

We define and examine a special chains of ellipses inside the branch $x > 0$ of the hyperbola, when the ratio of the minor and major axis is fixed. It is a natural extension of Lucca's circle chains. We describe the recurrence relations of center's sequences, major and minor axes, which determine another type of proof to give integer sequences.

We also examine special chains of circles and ellipses between the branches of hyperbola \mathcal{H} (or outside of \mathcal{H}), which

elements are tangent to the hyperbola \mathcal{H} and mutually tangent to each other.

We also define a special tangential chain of ellipses between the branches of \mathcal{H} , where the centers of the ellipses coincide with the centers of the circles. We give recurrence formulas for the parameters of ellipses.

We generate our result for 3-dimensional space when we consider the one sheeted hyperboloid of revolution $\mathcal{R}_{\mathcal{H}}$ with equation

$$\frac{x^2}{a^2} + \frac{y^2}{a^2} - \frac{z^2}{b^2} = 1, \quad (2)$$

which can be generated by rotating the hyperbola $\frac{x^2}{a^2} - \frac{z^2}{b^2} = 1$ around the minor axis z . Then we define and examine a tangential chain of spheres, later chain of ellipsoids inside the hyperboloid with fix ratio of axes.

Our other main purpose is to give integer sequences, which describe the parameters of our chains, we should notice that our results contain Lucca's results.

We found more then fifty such integer sequences which appear in the On-Line Encyclopedia of Integer Sequences (OEIS [5]), and thus our investigation give them geometrical interpretations.

We mention that there are some sequences, ie. A098706, which have only definition and have not any combinatorial or geometry example. Our paper could provide a geometric interpretation for them.

In number theory there are hundreds of articles dealing with balancing numbers and the sequence of balancing numbers (A001109), ex., see [4]. In our work this sequence also appears.

2 Associated integer sequences of chains

In this section we give some examples of integer sequences

a	b	t	$\{\beta_n\}$
2	1	2	{1, 19, 321, 5779, 103681, 1860499, ...}
3	1	3	{1, 59, 2161, 82139, 3119041, 118441499, ...}
4	1	4	{1, 135, 8705, 574599, 37914625, 2501790855, ...}
4	2	2	{2, 38, 642, 11558, 207362, 3720998, ...}

Table 1: Integer sequences associated to ellipse chains.

where β_n the height of the ellipses.

Some integer sequences associated to ellipsoid chains:

A001109, A001542, A106328, A005319, A276598, A075848, {0, 7, 42, 245, 1428, 8323, ...}, A081554, A276602, {0, 10, 60, 350, 2040, 11890, ...}, A001541, A003499, A106329, {4, 12, 68, 396, 2308, 13452, 78404, ...}, {5, 15, 85, 495, 2885, 16815, 98005, ...}.

References

- [1] Giovanni Lucca. Integer sequences and circle chains inside a hyperbola. In *Forum Geometricorum*, pages 11–16. Volume 19, 2019.
- [2] Hacène Belbachir, László Németh, and Soumeiya Merwa Tebtoub. Integer sequences and ellipse chains inside a hyperbola. *Annales Mathematicae et Informaticae*, doi: 10.33039/ami.2020.06.002. In <https://ami.uni-eszterhazy.hu>.
- [3] Hacène Belbachir, László Németh, and Soumeiya Merwa Tebtoub. Ellipse chains and the associated integer sequences. *Submitted article*.
- [4] Murat Alp, Nurettin Irmak, and László Szalay. Balancing diophantine triples with distance 1. In *Period. Math. Hung.* **71**(1), (2015), 1–10.
- [5] N.J.A. Sloane (editor). The On-Line Encyclopedia of Integer Sequences. In <https://oeis.org>

BI^sNOMIAL COEFFICIENTS AND s-LAH NUMBERS.

Imène Touaibia

USTHB, Faculty of Mathematics,
RECITS Laboratory,
P. Box 32, El Alia, 16111, Bab Ezzouar, Algiers, Algeria
ttouaibia@outlook.com

Hacène Belbachir

USTHB, Faculty of Mathematics,
RECITS Laboratory,
P. Box 32, El Alia, 16111, Bab Ezzouar, Algiers, Algeria
hacenebelbachir@gmail.com

Miloud MIHOUBI

USTHB, Faculty of Mathematics,
RECITS Laboratory,
P. Box 32, El Alia, 16111, Bab Ezzouar, Algiers, Algeria
miloudmihoubi@gmail.com

ABSTRACT

We construct in this work two formulas of the exponential generating function of the bi^snomial coefficients. Using these generating functions, we give some formulas and properties of the bi^snomial coefficients and the s-Lah numbers.

Keywords Binomial coefficients · ordinary generating function · exponential generating function · Lah numbers.

1 Introduction

For $s \geq 1$, the bi^snomial coefficients [1] denoted by $\binom{n}{k}_s$, where $\binom{n}{k}_s = 0$ for $k \notin \{0, 1, 2, \dots, sn\}$, are the positive integers that occur as coefficients of the x^k term in the multinomial expansion

$$\sum_{k=0}^{ns} \binom{n}{k}_s x^k = (1 + x + x^2 + \dots + x^s)^n. \quad (1)$$

For $s = 1$, we get the classical binomial coefficients.

Therefore, the bi^snomial coefficients can be seen as an extension of the binomial coefficients, and they generalize the most important properties (see [2] and [3] for instance) of the $\binom{n}{k}$ coefficients:

They verify the following recurrence relations

$$\binom{n}{k}_s = \sum_{i=1}^s \binom{n-1}{k-i}_s, \quad (2)$$

$$\binom{n}{k}_s = \sum_{i=0}^n \binom{n}{i} \binom{i}{k-i}_{s-1}. \quad (3)$$

They verify the symmetry relation

$$\binom{n}{k}_s = \binom{n}{sn-k}_s. \quad (4)$$

Using the binomial coefficients, these coefficients can be expressed as follows

$$\binom{n}{k}_s = \sum_{i_1+i_2+\dots+i_s=k} \binom{n}{i_1} \binom{i_1}{i_2} \dots \binom{i_{s-1}}{i_s}. \quad (5)$$

The s -Lah numbers [6] is a restricted class of the Lah numbers (see for instance [4] and [5]) denoted by $\left[\begin{smallmatrix} k \\ j \end{smallmatrix} \right]^{\leq s}$, and which counts the number of partitions of a k -set into j ordered blocks such that the cardinality of any block is at most s , and they have the following properties:

- they have the following exponential generating function

$$\sum_{k \geq 0} \left[\begin{smallmatrix} k \\ j \end{smallmatrix} \right]^{\leq s} \frac{t^k}{k!} = \frac{1}{j!} \left(\sum_{m=1}^s t^m \right)^j = \frac{1}{j!} \left(\frac{t(1-t^s)}{1-t} \right)^j. \quad (6)$$

- they have the following exact expression

$$\left[\begin{smallmatrix} k \\ j \end{smallmatrix} \right]^{\leq s} = \sum_{\substack{j_1+2j_2+\dots+s j_s=k \\ j_1+j_2+\dots+j_s=j}} \frac{k!}{j_1! j_2! \dots j_s!}. \quad (7)$$

- and using the bi^snomial coefficients [3], they have the following expression

$$\left[\begin{smallmatrix} k \\ j \end{smallmatrix} \right]^{\leq s} = \frac{k!}{j!} \binom{j}{k-j}_{s-1}. \quad (8)$$

2 Main results

Our main result is the construction of two formulas of the exponential generating function of the the bi^snomial coefficients, one of which is obtained by using the s -Lah numbers. Using these two formulas, we give some recurrence relations for the bi^snomial coefficients, the ordinary generating function of the s -Lah numbers and we conclude by showing the log concavity and the unimodality of this class of numbers.

References

- [1] H. Belbachir, A. Benmezai. A q-analogue for bisnomial coefficients and generalized Fibonacci sequences. *Comptes Rendus Mathematique*. 352(3): 167–171, 2014.
- [2] A. Bazeniar, M. Ahmia, H. Belbachir. Connection between bisnomial coefficients and their analogs and symmetric functions. *Turkish Journal of Mathematics* 42(3): 807–818, 2018.
- [3] H. Belbachir, S. Bouroubi, A. Khelladi. Connection between ordinary multinomials, Fibonacci numbers, Bell polynomials and discrete uniform distribution. *Annales Math. et Informaticae*, 35, 21-30, 2008.
- [4] H. Belbachir, I. E. Bousbaa. Combinatorial identities for the r-Lah numbers. *Ars Comb.* 115:453-458, 2014.
- [5] H. Belbachir, A. Belkhir. Cross recurrence relations for r-Lah numbers. *Ars Comb.* 110:199-203, 2013.
- [6] M. Mihoubi, M. Rahmani. The partial r-Bell polynomials. *Afrika Matematika* 28(7-8):1167-1183, 2017.

ON GENERALIZATION OF BI-PERIODIC r -NUMBERS

N. Rosa AIT-AMRANE*

Department of Mathematics and Computer Science, Yahia Fares University
Medea, Algeria
USTHB, Faculty of Mathematics, RECITS Laboratory, 16111 Bab-Ezzouar
Algiers, Algeria
rosamrane@gmail.com

ABSTRACT

We define a new class of the bi-periodic r -Fibonacci sequence. Then, we introduce a new family of the companion sequences of the bi-periodic r -Fibonacci sequence, named bi-periodic r -Lucas sequence of type s , which extend the classical Fibonacci and Lucas sequences. Afterwards, we establish the link between the bi-periodic r -Fibonacci sequence and its companion sequence. Furthermore, we give their basic properties linear recurrence relations, generating functions, Binet formulas and explicit formulas.

Keywords Bi-periodic Fibonacci sequence, bi-periodic Lucas sequence, generating function, Binet formula, explicit formula.

1 Introduction

Yazlik et al. [3] introduced generalization of the bi-periodic Fibonacci r -numbers (f_n) , for r a positive integer and a, b a positive real numbers by, for $n \geq r + 1$

$$f_n = \begin{cases} af_{n-1} + f_{n-r-1}, & \text{for } n \equiv 0 \pmod{2}, \\ bf_{n-1} + f_{n-r-1}, & \text{for } n \equiv 1 \pmod{2}, \end{cases} \quad (1)$$

and the bi-periodic Lucas r -numbers (l_n) by, for $n \geq r + 1$

$$l_n = \begin{cases} bl_{n-1} + l_{n-r-1}, & \text{for } n \equiv 0 \pmod{2}, \\ al_{n-1} + l_{n-r-1}, & \text{for } n \equiv 1 \pmod{2}, \end{cases} \quad (2)$$

with the initial conditions $f_0 = 0, f_1 = 1, f_2 = a, \dots, f_r = a^{\lfloor r/2 \rfloor} b^{\lfloor (r-1)/2 \rfloor}$ and $l_0 = r + 1, l_1 = a, l_2 = ab, \dots, l_r = a^{\lfloor (r+1)/2 \rfloor} b^{\lfloor r/2 \rfloor}$, respectively.

We define a new class of the bi-periodic r -Fibonacci sequence $(U_n^{(r)})_n$ and we give its linear recurrence relation. We introduce a new family of companion sequences associated to the bi-periodic r -Fibonacci sequence indexed by the parameter s ; with $1 \leq s \leq r$; named the bi-periodic r -Lucas sequence of type s , $(V_n^{(r,s)})_n$. After that, we express $V_n^{(r,s)}$ in terms of $U_n^{(r)}$ and s . Then we give some algebraic properties.

2 The bi-periodic r -Fibonacci sequence

First, we define the bi-periodic r -Fibonacci sequence $(U_n^{(r)})_n$ and give its linear recurrence relation. For a, b, c, d nonzero real numbers and $r \in \mathbb{N}$, the bi-periodic r -Fibonacci sequence $(U_n^{(r)})_n$ is defined by, for $n \geq r + 1$

$$U_n^{(r)} = \begin{cases} aU_{n-1}^{(r)} + cU_{n-r-1}^{(r)}, & \text{for } n \equiv 0 \pmod{2}, \\ bU_{n-1}^{(r)} + dU_{n-r-1}^{(r)}, & \text{for } n \equiv 1 \pmod{2}, \end{cases} \quad (3)$$

*rosamrane@gmail.com

with the initial conditions $U_0^{(r)} = 0, U_1^{(r)} = 1, U_2^{(r)} = a, \dots, U_r^{(r)} = a^{\lfloor r/2 \rfloor} b^{\lfloor (r-1)/2 \rfloor}$. The bi-periodic r -Fibonacci sequence can be expressed by linear recurrence relation. For a, b, c, d nonzero real numbers and $r \in \mathbb{N}$, the bi-periodic r -Fibonacci sequence satisfies the following linear recurrence, for $n \geq 2r + 2$

$$U_n^{(r)} = abU_{n-2}^{(r)} + (a^{\xi(r+1)}d + b^{\xi(r+1)}c)U_{n-r-1-\xi(r+1)}^{(r)} - (-1)^{r+1}cdU_{n-2r-2}^{(r)}. \quad (4)$$

3 The bi-periodic r -Lucas sequence of type s

Secondly, we introduce a new family of companion sequences related to the bi-periodic r -Fibonacci sequence, called the bi-periodic r -Lucas sequence of type s , $(V_n^{(r,s)})_n$. For any nonzero real numbers a, b, c, d and integers s, r such that $1 \leq s \leq r$, we define for $n \geq r + 1$

$$V_n^{(r,s)} = \begin{cases} bV_{n-1}^{(r,s)} + dV_{n-r-1}^{(r,s)}, & \text{for } n \equiv 0 \pmod{2}, \\ aV_{n-1}^{(r,s)} + cV_{n-r-1}^{(r,s)}, & \text{for } n \equiv 1 \pmod{2}, \end{cases} \quad (5)$$

with the initial conditions $V_0^{(r,s)} = s + 1, V_1^{(r,s)} = a, V_2^{(r,s)} = ab, \dots, V_r^{(r,s)} = a^{\lfloor (r+1)/2 \rfloor} b^{\lfloor r/2 \rfloor}$. The bi-periodic r -Fibonacci sequence $(U_n^{(r)})_n$ and the bi-periodic r -Lucas sequence of type s , $(V_n^{(r,s)})_n$ can be seen as a generalization of the Fibonacci and Lucas sequences, we will list some particular cases. The bi-periodic r -Lucas sequence of type s , $1 \leq s \leq r$ satisfy the following linear recurrence relation. For a nonzero real numbers a, b, c, d and s, r such that $1 \leq s \leq r$, the family of the bi-periodic r -Lucas sequence of type s satisfy, for $n \geq 2r + 2$

$$V_n^{(r,s)} = abV_{n-2}^{(r,s)} + (a^{\xi(r+1)}d + b^{\xi(r+1)}c)V_{n-r-1-\xi(r+1)}^{(r,s)} - (-1)^{r+1}cdV_{n-2r-2}^{(r,s)}. \quad (6)$$

After that, we express the bi-periodic r -Lucas sequence of type s , $V_n^{(r,s)}$ in terms of $U_n^{(r)}$. Let r and s be nonnegative integers such that $1 \leq s \leq r$, the bi-periodic r -Fibonacci sequence and the bi-periodic r -Lucas sequence of type s satisfy the following relationship

$$V_n^{(r,s)} = \begin{cases} U_{n+1}^{(r)} + sdU_{n-r}^{(r)}, & n \geq r, \quad \text{for } r \text{ odd}, \\ U_{n+1}^{(r)} + scbU_{n-r-1}^{(r)} + scdU_{n-2r-1}^{(r)}, & n \geq 2r + 1, \quad \text{for } r \text{ even}. \end{cases} \quad (7)$$

4 Main results

We also give the generating functions of the bi-periodic r -Fibonacci sequence and the bi-periodic r -Lucas sequence of type s . Then, we express an explicit formulas of $(U_n^{(r)})_n$ and $(V_n^{(r,s)})_n$. Finally, we give the Binet Formulas of them.

References

- [1] S. Abbad, H. Belbachir, B. Benzaghrou, *Companion sequences associated to the r -Fibonacci sequence: algebraic and combinatorial properties*, Turkish Journal of Mathematics, 43 (3) (2019), 1095-1114.
- [2] H. Belbachir, F. Bencherif, *Linear recurrent sequences and powers of a square matrix*, Integers 6 (2006), A12, 17pp.
- [3] Y. Yazlik, C. Köme, V. Madhusudanan, *A new generalization of Fibonacci and Lucas p -numbers*. Journal of computational analysis and applications 25 (4), (2018), 657-669.

FROM TERNARY ABSTRACT COSETS TO GROUPS AND FROM MEDIAN TO SEMILATTICES VIA BASEPOINTS: COMMENTS ON ANALOGIES

Stephan Foldes
University of Miskolc
3515 Miskolc, Hungary
foldes.istvan@uni-miskolc.hu

Gerasimos Meletiou
University of Ioannina
Arta, GR-47150, Greece
gmelet@uoi.gr

ABSTRACT

Some analogies between the ternary median operation in a distributive lattice and the ternary operation $a \cdot b^{-1} \cdot c$ in a group [8] were noted in the 40's papers of Grau [4] and of Birkhoff and Kiss [5], and substantially expanded in Knobel's recent article [9]. For these ternary operations commutativity of the groups is not an essential requirement, and beyond distributive lattices a larger class of semilattices is considered, called median semilattices. In this further comments are made in the line of an earlier paper of one of the present authors [2].

In that sense median algebras ([3], [6], [7]) and abstract cosets ([8], [9],[10]) can be studied in parallel and compared due to their analogous properties. Both of them are ternary algebraic structures. By fixing the central operand (the second one) a collection of binary operations is derived. For a median algebra we get a family of mutually distributive semilattice operations; for an abstract coset we get a family of mutually paraassociative group structures. In both cases the original ternary operation can be reconstructed from any of the derived binary operations.

In any group, where the group operation is denoted o the passage from the operation o to another group operation ω with neutral element b^{-1} is specified by defining $\omega c = aobc$. This is equivalent to Certainé's scheme [8] which takes for every b the product $a \cdot b^{-1} \cdot c$. This way the new operation $\omega c = aobc$ can be defined not only in groups, but in any semigroup, even if b has no inverse.

In any median semilattice, where meet is denoted by \wedge and join – when it exists – is denoted by \vee , the passage to the meet operation \hat{b} of another median semilattice with minimum element b is specified by defining $\hat{b}c = (a \wedge b) \vee (b \wedge c) \vee (a \wedge c)$. Even if the original semilattice is actually a lattice, the semilattice defined by the new meet operation will generally not be a lattice. In fact in the integer lattices discussed above, it will not be a lattice for any choice of the basepoint element b . However, in the case of a finite, n -dimensional Boolean lattice, the new semilattice will define another n -dimensional Boolean lattice for any choice of the basepoint element b . We note that for a tree semilattice - trivially - the new semilattice will also be a tree, and never a lattice if the original tree semilattice is not one.

The paradigmatic example we propose is that of the integer lattice (grid) in n -dimensional space. In any visual representation it appears as a $2n$ -regular infinite graph. As a discrete model for physical space (say for $n = 3$) it exhibits the obvious relativity of the notion of origin, and of the arbitrariness of the choosing X , Y and Z axes in a coordinatization.

The classical algebraic structure of the integer lattice is the commutative group structure (or \mathbb{Z} -module), which can be defined once an origin is chosen. In fact this group structure is completely determined by the choice of the origin, with no need for coordinatization by n -tuples of numbers. The various groups obtained this way are all isomorphic.

The classical order structure on the integer grid, on the other hand, is the distributive lattice structure that is usually described as a vectorial order (or Laurent monomial order) based on a chosen coordinatization by integer n -tuples (which can in fact also be achieved without coordinatization, in terms

of the graph structure of the grid alone). The distributive lattice structures obtained this way are all isomorphic. There is, however, a meet semilattice structure obtained for each choice of the origin, by defining a vertex x to be smaller or equal to y if it lies on a shortest graph-theoretical path between the origin and y . The meet semilattices so obtained are not lattices, but they are all isomorphic to each other: they are called base-point semilattices.

References

- [1] G. Birkhoff, Some applications of universal algebra. In *Colloq. Math. Soc. Janos Bolyai 29 (Universal algebra, Esztergom, 1977)*, pages 107–128.
- [2] G.C. Meletiou, Median algebras acting on sets. In *Algebra Universalis 29*, pages 477–484, 1992.
- [3] H. J. Bandelt and J. Hedlikova, Median algebras. *Discrete mathematics, vol. 45*, pages 1–30, 1983.
- [4] A.A. Grau, Ternary boolean algebra. *Bull. Amer. Math. Soc. 53*, pages 567–572, 1947.
- [5] G. Birkhoff and S.A. Kiss, A ternary operation in distributive lattices. *Bull. Amer. Math. Soc. 53*, pages 749–752, 1947.
- [6] M. Sholander, “Medians, lattices, and trees”. *Proc. American Mathematical Society, 5(5)*, pages 808—812, 1954.
- [7] M. Sholander, Trees, lattices, order, and betweenness. *Proc. Am. Math. Soc. 3(3)*, pages 369—381 , 1952.
- [8] J. Certaine, The ternary operation $(abc) = ab^{-1}c$ of a group. *Bull. Amer. Math. Soc. 49*, pages 869 – 877, 1943.
- [9] A. Knoebel, Flocks, groups and heaps, joined with semilattices. *Quasigroups and Related Systems 24*, pages 43 – 66, 2016.
- [10] C. Hollings and M. Lawson, Wagner’s Theory of Generalised Heaps. *Springer International Publishing AG*, 2017.

ON THE ENUMERATION OF P -OLIGOMORPHIC GROUPS

Justine Falque*

ABSTRACT

We describe an algorithm to enumerate (closed) P -oligomorphic permutation groups per profile growth, up to kernel, and we announce its implementation as an ongoing work. This work is based on the recent classification of P -oligomorphic groups from [1].

Keywords Infinite permutation groups · profile · P -oligomorphic groups · blocks · computer algebra · enumeration

1 Introduction

Given a permutation group G of a set E , the *profile* of G is the sequence that counts, for every nonnegative integer n , the G -orbits of degree n : that is, the orbits of the induced action of G on the subsets of size n of E . In the seventies, Cameron initiated the study of infinite permutation groups of countably infinite sets whose profile took only finite values, calling them *oligomorphic groups*[2].

When, in addition, the profile is bounded by a polynomial, the group may be called *P -oligomorphic*. In that case, as once conjectured by Cameron, the profile has been recently shown by the author and Thiéry to be asymptotically equivalent to a polynomial [3], and the *profile growth* refers to the degree of this polynomial.

Along with the resolution of the conjecture, these groups have been classified [1]: basically, a P -oligomorphic group is uniquely and entirely described by a finite permutation group endowed with a block system, each block of which is decorated by a pair of groups — one finite, the other infinite — satisfying some explicit conditions.

This extended abstract presents an algorithm, based on this classification, that allows to enumerate all closed P -oligomorphic groups per profile growth, up to kernel (for else there would be infinitely many groups for each growth), the closure notion referring to the simple convergence topology. It is being implemented using the software SageMath [4] and features from GAP-system [5]. The obtained counting sequence will hopefully be presented at the ALGOS2020 conference.

This paper is dedicated to Maurice Pouzet on the occasion of his 75th birthday. Oligomorphic groups are a particular case of relational structures, which are one of his domains of predilection, and he is at the origin of my work on oligomorphic groups.

2 Enumeration of (closed) P -oligomorphic groups

2.1 Generation of finite permutation groups

As it is the first brick in the classification, the first step is to generate all finite permutation groups F , up to permutation group isomorphism. They are counted, per degree, by the following sequence (A000638):

1, 1, 2, 4, 11, 19, 56, 96, 296, 554, 1593, 3094, 10723, ...

We implemented this using the GAP Data Library “Transitive Groups”, thanks to the property that any intransitive group is a *subdirect product* of transitive groups.

*Webpage of the author,

mail: justine.falque@lilo.org

The method used is essentially that described in [6]. Roughly speaking, for each domain size N , one needs to enumerate all partitions of N , which represent the possible sets of orbits; then, for each one of them, choose a transitive group F_i on each orbit, and finally compute the subdirect products of these groups in order to generate all permutation groups with these orbits. Some care can be taken at different stages of the generation in order to limit the production of isomorphic groups, yet the author could not spare a final conjugacy test. As the references consulted about this did not include any code, we created a repository to share our implementation with SageMath. The enumeration of P -oligomorphic groups should be available there as well by the time of the conference.

2.2 Enumeration of P -oligomorphic groups using their classification

2.2.1 Block systems of intransitive groups

Once the finite permutation groups have been generated, there remains to enumerate their *block systems*: generalizing the usual definition to intransitive groups, a block system is a set partition of the domain that is globally stable under the action of the group.

As for the previous one, this step needs some implementation work. Indeed, the implementation of block systems in GAP (and thereby SageMath) requires the group to be transitive, and therefore requires to be extended. This involves considering the automorphism group of the finite permutation group F that is being processed, more precisely its action on the orbit restrictions F_i .

There are some technical issues to handle along the way: for instance, the fact that trivial block systems are not included in the output of `AllBlocks`, or that fixed points are removed when GAP computes an action. In addition, one must manually consider the systems involving blocks that are union of orbits — all that up to isomorphism.

2.2.2 The decorations and profile growth

The final layer, in the enumeration as in the classification, is the choice of *decorations* for each one of the orbits of blocks of the finite permutation group F : on the one hand, a normal subgroup H_i of the induced action of F on one of the blocks of this orbit; on the other hand, a (closed) *highly homogeneous group*. There are five of this latter kind of groups, but only one (the infinite symmetric group) is possible if the blocks are not singletons.

This step corresponds to choosing the behaviour of the final P -oligomorphic group inside each one of its *superblocks*. It must again be carried out up to isomorphism.

When a P -oligomorphic group is finally obtained this way, one determines its profile growth using the profiles of the H_i 's (the profile has been previously implanted by the author as a method for finite permutation groups). Indeed, it corresponds to the total number of orbits of subsets of the H_i 's, minus one. This ensures that it is (tightly) bounded above by the degree of F minus one, so when asking for the number of P -oligomorphic groups up to growth r , one needs to consider finite groups F up to degree $r + 1$.

Note that the whole enumeration is much easier when counting only transitive P -oligomorphic groups. An implementation can be found in the same repository, and hands the sequence:

1, 5, 6, 14, 33, 32, 114, 47, 323, 260, 338, 50, 2108, 58, 430, 940, 12470, 60, 7361, 64, 12136, . . .

which is unknown by OEIS.

References

- [1] Justine Falque and Nicolas M. Thiéry. Classification of P -oligomorphic groups, conjectures of Cameron and Macpherson. Submitted, 39 pages, arXiv:2005.05296 [math.CO], May 2020.
- [2] P. J. Cameron. *Oligomorphic permutation groups*, volume 152 of *London Mathematical Society Lecture Note Series*. Cambridge University Press, Cambridge, 1990.
- [3] Justine Falque and Nicolas M. Thiéry. The orbit algebra of a permutation group with polynomial profile is Cohen-Macaulay. In *30th International Conference on Formal Power Series and Algebraic Combinatorics (FPSAC 2018, Hanover)*, February 2018.
- [4] The Sage Developers. *SageMath, the Sage Mathematics Software System (Version 9.0)*, 2020. <https://www.sagemath.org>.
- [5] The GAP Group, Aachen, St Andrews. *GAP – Groups, Algorithms, and Programming, Version 4.10*, 1999.
- [6] Derek F. Holt. Enumerating subgroups of the symmetric group. 2010. oeis.org/A000638.

LOG-CONCAVITY AND UNIMODALITY IN ARITHMETICAL TRIANGLES

Assia F. TEBTOUB

USTHB, Faculty of Mathematics, RECITS Lab.
PB 32, El Alia, 16111, Bab Ezzouar, Algeria
atebtoub@gmail.com

ABSTRACT

In this work, we establish log-concavity and unimodality in some well-known arithmetical triangles.

Keywords Arithmetical triangles · Log-concavity · Unimodality

A real sequence $(a_k)_{k=0}^n$ is unimodal if it rises to a maximum a_{k_0} and then decreases, the entire a_{k_0} is called the mode of the sequence (a_k) . And it is logarithmically concave (log-concave) if $a_{i-1}a_{i+1} \leq a_i^2$, for $i = 1, \dots, n-1$. It is known that a log-concave sequence is unimodal. Many combinatorial sequences are unimodal and the well known example is the sequence of binomial coefficients. The simplicity of its explicit formula makes easy the proof of its unimodality. The concept of unimodality is simple and obviously assimilated, but its elaboration is not always easy, since many sequences are not as explicit as the Newton's sequence. The question of unimodality has been the object of diverse articles under different aspects: proof of unimodality [8, 10], detection of modes [5], or the enumeration of the methods to prove unimodality [1, 6, 9].

We are interested in our work on the study of sequences linked to different arithmetical triangles. Principally, we are inspired by the works that have been already done on the most known triangle, which is: the Pascal triangle. The first result of unimodality in Pascal's triangle other than the binomial coefficient is due to Tanny and Zuker [10]. Many other works treat the question of unimodality of sequences linked to different directions of this triangle. And then comes the work of Belbachir and Szalay [2], where they showed that any sequence lying over any finite direction in Pascal's triangle is unimodal. By analogy to these works, we propose to study the unimodality of sequences linked to arithmetical triangles other than Pascal's triangle, and this using different methods.

We deal in this work with many arithmetical triangles such as: Stirling triangle of second kind [3, 4], Lah triangle [11], associated Stirling triangle and the Eulerian triangle.

References

- [1] M. Balazard. Quelques exemples de suites unimodales en théorie des nombres. In *Journal de théorie des nombres de Bordeaux*, pages 13–30, 1990.
- [2] H. Belbachir, L. Szalay. Unimodal rays in the regular and generalized Pascal triangles. In *J. of Integer Seq.*, 11, Article. 08.2.4., 2008.
- [3] H. Belbachir, A. F. Tebtoub. Les nombres de Stirling associés avec succession d'ordre 2, nombres de Fibonacci-Stirling et unimodalité. *C. R. Acad. Sci. Paris, Ser. I*, 2015.
- [4] H. Belbachir, A. F. Tebtoub. The t-successive associated Stirling numbers, t-Fibonacci Stirling numbers and Unimodality. *Turkish Journal of Mathematics*, pages 1279–1291, 2017.
- [5] M. Benoumhani. Sur une propriétés des polynômes à racines négatives. *Journal de mathématiques pures et appliqués*, 75(2), pages 85–105, 1996.

- [6] F. Brenti. Unimodal, log-concave and Pólya frequency sequences in combinatorics. *American Mathematical Soc.*, V413, 1989.
- [7] E. R. Canfield. Location of the maximum Stirling number(s) of second kind. *Studies in App Math*, 59, pages 83–93, 1978.
- [8] L. H. Harper. Stirling behaviour is asymptotically normal. *Ann. Math. Stat.*, 38, pages 410–414, 1967.
- [9] R. P. Stanley. Log-concave and unimodal sequences in Algebra, Combinatorics and Geometry. *Annals of the New York academy of sciences*, 576(1), pages 500–535, 1989.
- [10] S. Tanny, M. Zuker. On unimodality sequence of binomial coefficients. *Discrete Math.*, 9, pages 79–89, 1974.
- [11] A. F. Tebtoub. Log-concavity of principal diagonal rays in the regular Lah triangles. *Ars Combinatorias*, V114, pages 75–83, 2018.

Short papers

DECOMPOSITION SCHEMES FOR SYMMETRIC n -ARY BANDS

Jimmy Devillet

Department of Mathematics
University of Luxembourg
Luxembourg
jimmy.devillet@uni.lu

Pierre Mathonet

Department of Mathematics
University of Liege
Liege, Belgium
p.mathonet@uliege.be

ABSTRACT

We extend the classical (strong) semilattice decomposition scheme of certain classes of semigroups to the class of idempotent symmetric n -ary semigroups (i.e. symmetric n -ary bands) where $n \geq 2$ is an integer. More precisely, we show that these semigroups are exactly the strong n -ary semilattices of n -ary extensions of Abelian groups whose exponents divide $n - 1$. We then use this main result to obtain necessary and sufficient conditions for a symmetric n -ary band to be reducible to a semigroup.

Keywords Semigroup · idempotency · semilattice decomposition · reducibility

1 Introduction

Semigroups are ubiquitous and have numerous applications both in theoretical and applied mathematics. An extensive study of these structures began in the second half of the 20th century (see the pioneering works [2] and [19], or the textbooks [3, 10, 12, 20, 21] and references therein). In the algebraic analysis of semigroups, it soon became clear that it was useful to obtain a *decomposition scheme* of the semigroup under consideration into subsemigroups that are easier to describe or have additional properties (e.g. being groups), but also to be able to build a semigroup by combining given subsemigroups in a suitable way, that is, to use a *composition scheme* for semigroups.

Several classes of semigroups have the remarkable property to admit such composition/decomposition schemes; see, e.g., Krohn-Rhodes theorem for finite semigroups and finite automata [14]. A noteworthy example of such a scheme is given by strong semilattice decompositions of certain classes of bands¹. In this paper we generalize these strong semilattice decompositions to structures with higher arities, defined as follows.

An n -ary operation $F: X^n \rightarrow X$ (where $n \geq 2$ is an integer and X is a non-empty set) is *associative* if

$$F(x_1, \dots, x_{i-1}, F(x_i, \dots, x_{i+n-1}), x_{i+n}, \dots, x_{2n-1}) = F(x_1, \dots, x_i, F(x_{i+1}, \dots, x_{i+n}), x_{i+n+1}, \dots, x_{2n-1}), \quad (1)$$

for all $x_1, \dots, x_{2n-1} \in X$ and all $1 \leq i \leq n - 1$. If F is an n -ary associative operation on X , then (X, F) is an *n -ary semigroup*. These n -ary structures, first studied in [9] and [22], have applications in different fields such as automata theory (see, e.g., [11]), coding theory, and cryptology (see, e.g., [16, 17]).

The classical definitions of symmetry and idempotency can also be extended to n -ary operations as follows: F is *idempotent* if $F(x, \dots, x) = x$ for every $x \in X$ and F is *symmetric* (or *commutative*) if F is invariant under the action of permutations.

Many examples of n -ary semigroups are obtained by extending binary semigroups: if $G: X^2 \rightarrow X$ is an associative operation, then we can define a sequence of operations inductively by setting $G^1 = G$, and

$$G^m(x_1, \dots, x_{m+1}) = G^{m-1}(x_1, \dots, x_{m-1}, G(x_m, x_{m+1})), \quad m \geq 2.$$

Setting $F = G^{n-1}$, it is straightforward to see that the pair (X, F) is indeed an n -ary semigroup. It is said to be the *n -ary extension* of (X, G) and we say that (X, F) is *reducible* to (X, G) ². However, not every n -ary semigroup

¹A band is a semigroup (X, G) where X is a nonempty set and the binary associative operation $G: X^2 \rightarrow X$ satisfies $G(x, x) = x$ for every $x \in X$; see, e.g., [12] for more details.

²We also say that F is the n -ary extension of G or that F is reducible to G or even that G is a binary reduction of F .

is the n -ary extension of a binary semigroup. For instance, the ternary associative operation F defined on \mathbb{R}^3 by $F(x_1, x_2, x_3) = x_1 - x_2 + x_3$ is not reducible to any binary associative operation. The problem of reducibility was considered recently in [13, 18] for n -ary semigroups endowed with additional structures and in [1, 4, 6] for the class of quasitrivial n -ary semigroups³. These are n -ary semigroups (X, F) that preserve all unary relations, i.e., such that $F(x_1, \dots, x_n) \in \{x_1, \dots, x_n\}$ for all $x_1, \dots, x_n \in X$. It was shown [4] that all quasitrivial n -ary semigroups are reducible. Then in [5], the authors relaxed the quasitriviality condition by considering operations whose restrictions on certain subsets of the domain are quasitrivial. It turns out that these operations are also reducible.

In this work we study the class of symmetric (or commutative) n -ary bands, that is, symmetric idempotent n -ary semigroups. Typical examples of symmetric n -ary bands are given by n -ary extensions of semilattices and n -ary extensions of Abelian groups whose exponents divide $n - 1$. Both classes of examples will play a central role in our constructions. However, as shown in the following examples, not every symmetric n -ary band is obtained in this way.

Example 1.1. (a) We consider the set $X = \{1, 2, 3, 4\}$ and we define the symmetric ternary operation $F_1: X^3 \rightarrow X$ by its level sets given (up to permutations) by $F_1^{-1}(\{1\}) = \{(1, 1, 1)\}$, $F_1^{-1}(\{2\}) = \{(2, 2, 2)\}$, $F_1^{-1}(\{3\}) = \{(1, 1, 2), (1, 1, 3), (1, 2, 4), (1, 3, 4), (2, 2, 3), (2, 3, 3), (2, 4, 4), (3, 3, 3), (3, 4, 4)\}$. Then $F_1^{-1}(\{4\})$ is made up of all the remaining elements of X^3 . This operation defines a symmetric ternary band and is not reducible to any binary operation.

(b) We consider the set $X = \{1, 2, 3\}$ and we define the symmetric ternary operation $F_2: X^3 \rightarrow X$ again by its level sets given (up to permutations) by $F_2^{-1}(\{1\}) = \{(1, 1, 1)\}$, $F_2^{-1}(\{2\}) = \{(1, 1, 2), (1, 2, 2), (1, 3, 3), (2, 2, 2), (2, 3, 3)\}$, and $F_2^{-1}(\{3\}) = \{(1, 1, 3), (1, 2, 3), (2, 2, 3), (3, 3, 3)\}$. This operation defines a symmetric ternary band. It turns out that it is reducible to a binary operation on X .

In the next section we define the n -ary counterpart of the classical strong semilattice (de)composition for semigroups (namely the strong n -ary semilattice decomposition). We show that it enables us to compose n -ary semigroups: every strong n -ary semilattice of n -ary semigroups is an n -ary semigroup (see Proposition 2.2). Then in Section 3, we provide a constructive description of the class of symmetric n -ary bands, that is, we show that the symmetric n -ary bands are exactly the strong n -ary semilattices of n -ary extensions of Abelian groups whose exponents divide $n - 1$ (see Theorem 3.12). In the final section, we give a reducibility criterion for symmetric n -ary bands based on their strong n -ary semilattice decomposition (see Proposition 4.3). Also, Example 1.1 shows how these constructions enable us to build and analyze examples of symmetric n -ary bands. Almost all the definitions and results in this work stem from [7], where the reader may find their proofs and alternative developments as well.

2 Strong n -ary semilattices of n -ary semigroups

Throughout this work, we consider a nonempty set X and an integer $n \geq 2$. Recall that (X, F) is said to be an n -ary groupoid whenever $F: X^n \rightarrow X$ is an n -ary operation. Moreover, if F is associative (i.e., satisfies (1)), then (X, F) is said to be an n -ary semigroup. The concepts of homomorphisms and isomorphisms of n -ary groupoids and n -ary semigroups are defined as usual.

Recall that $e \in X$ is said to be a *neutral element* for $F: X^n \rightarrow X$ if

$$F((k-1) \cdot e, x, (n-k) \cdot e) = x, \quad x \in X, k \in \{1, \dots, n\},$$

where, for any $k \in \{0, \dots, n\}$ and any $x \in X$, the notation $k \cdot x$ stands for the k -tuple x, \dots, x (for instance $F(3 \cdot x, 0 \cdot y, 2 \cdot z) = F(x, x, x, z, z)$).

In [8, Lemma 1], it was proved that any associative operation $F: X^n \rightarrow X$ having a neutral element e is reducible to an associative binary operation $G_e: X^2 \rightarrow X$ defined by

$$G_e(x, y) = F(x, (n-2) \cdot e, y), \quad x, y \in X. \quad (2)$$

Finally, recall that an equivalence relation \sim on X is said to be a *congruence* for $F: X^n \rightarrow X$ (or on (X, F)) if it is compatible with F , that is, if $F(x_1, \dots, x_n) \sim F(y_1, \dots, y_n)$ for any $x_1, \dots, x_n, y_1, \dots, y_n \in X$ such that $x_i \sim y_i$ for all $i \in \{1, \dots, n\}$. We denote by $[x]_\sim$ (or $[x]$ when there is no risk of confusion) the equivalence class of x for \sim and by \tilde{F} the map induced by F on X/\sim defined by

$$\tilde{F}([x_1]_\sim, \dots, [x_n]_\sim) = [F(x_1, \dots, x_n)]_\sim, \quad \forall x_1, \dots, x_n \in X.$$

³For $n = 2$, the quasitrivial semigroups were described by Langer [15].

We say that a congruence \sim on an n -ary groupoid (X, F) is an n -ary *semilattice congruence* if $(X/\sim, \tilde{F})$ is an n -ary semilattice⁴.

Now, let us extend the well-known concept of semilattice of semigroups to n -ary semigroups. Let (Y, \wedge) be a semilattice and let $\{(X_\alpha, F_\alpha) : \alpha \in Y\}$ be a set of n -ary semigroups such that $X_\alpha \cap X_\beta = \emptyset$ for any $\alpha \neq \beta$. We say that an n -ary groupoid (X, F) is an n -ary *semilattice* (Y, \wedge^{n-1}) of n -ary semigroups (X_α, F_α) if $X = \bigcup_{\alpha \in Y} X_\alpha$, $F|_{X_\alpha^n} = F_\alpha$ for every $\alpha \in Y$, and

$$F(X_{\alpha_1} \times \cdots \times X_{\alpha_n}) \subseteq X_{\alpha_1 \wedge \cdots \wedge \alpha_n}, \quad \alpha_1, \dots, \alpha_n \in Y. \quad (3)$$

In this case we write $(X, F) = ((Y, \wedge^{n-1}); (X_\alpha, F_\alpha))$ and we simply say that (X, F) is an n -ary semilattice of n -ary semigroups.

Actually, any decomposition of an n -ary semigroup (X, F) as an n -ary semilattice of n -ary semigroups is associated with an n -ary semilattice congruence on (X, F) ; see, e.g., [12] for the binary counterpart of this result.

The fact that an n -ary groupoid is an n -ary semilattice of n -ary semigroups is not sufficient to ensure that it is an n -ary semigroup. We need to introduce a generalization of the strong semilattice decomposition. This is done in the following definition.

Definition 2.1. Let $(X, F) = ((Y, \wedge^{n-1}); (X_\alpha, F_\alpha))$ be an n -ary semilattice of n -ary semigroups. Suppose that for any $\alpha, \beta \in Y$ such that $\alpha \geq \beta$ there is a homomorphism $\varphi_{\alpha, \beta} : X_\alpha \rightarrow X_\beta$ such that the following conditions hold.

- (a) The map $\varphi_{\alpha, \alpha}$ is the identity on X_α .
- (b) For any $\alpha, \beta, \gamma \in Y$ such that $\alpha \geq \beta \geq \gamma$ we have $\varphi_{\beta, \gamma} \circ \varphi_{\alpha, \beta} = \varphi_{\alpha, \gamma}$.
- (c) For any $(x_1, \dots, x_n) \in X_{\alpha_1} \times \cdots \times X_{\alpha_n}$ we have

$$F(x_1, \dots, x_n) = F_{\alpha_1 \wedge \cdots \wedge \alpha_n}(\varphi_{\alpha_1, \alpha_1 \wedge \cdots \wedge \alpha_n}(x_1), \dots, \varphi_{\alpha_n, \alpha_1 \wedge \cdots \wedge \alpha_n}(x_n)).$$

Then (X, F) is said to be a *strong n -ary semilattice* (Y, \wedge^{n-1}) of n -ary semigroups (X_α, F_α) . In this case we write $(X, F) = ((Y, \wedge^{n-1}); (X_\alpha, F_\alpha); \varphi_{\alpha, \beta})$ and we also say that (X, F) is a strong n -ary semilattice of n -ary semigroups.

This definition enables us to obtain the main result concerning the composition of n -ary semigroups, which is important on its own, but also in the next sections.

Proposition 2.2. *If (X, F) is a strong n -ary semilattice of n -ary semigroups, then it is an n -ary semigroup.*

3 The structure theorem

Throughout this section, we consider a symmetric n -ary band (X, F) . We associate with it a family of unary operations and study their most important properties.

Definition 3.1. For every $x \in X$, we define the operation $\ell_x^F : X \rightarrow X$ by

$$\ell_x^F(y) = F((n-1) \cdot x, y), \quad y \in X.$$

When there is no risk of confusion, we also denote this operation by ℓ_x . We now study elementary properties of this operation.

Example 3.2. For the structures presented in Example 1.1, these maps are given in the following tables.

y	1	2	3	4
$\ell_1(y)$	1	3	3	4
$\ell_2(y)$	4	2	3	4
$\ell_3(y)$	4	3	3	4
$\ell_4(y)$	4	3	3	4

y	1	2	3
$\ell_1(y)$	1	2	3
$\ell_2(y)$	2	2	3
$\ell_3(y)$	2	2	3

Proposition 3.3. *The pair $(\{\ell_x : x \in X\}, \circ)$ is a semilattice.*

We also observe that the pair (X, B) where B is defined by $B(x, y) = \ell_x(y)$ for all $x, y \in X$ is a band. For instance, the tables in Example 3.2 are the operation tables of the corresponding binary operations B . We will not elaborate on this in the present work but refer the reader to [7] for more details.

⁴We say that the n -ary extension of a semilattice is an n -ary *semilattice*.

The semilattice defined in Proposition 3.3 can be extended to define a symmetric n -ary band. The following result establishes a tight relation between (X, F) and this n -ary band.

Proposition 3.4. *For every $x_1, \dots, x_n \in X$ we have*

$$\ell_{F(x_1, \dots, x_n)} = \ell_{x_1} \circ \dots \circ \ell_{x_n},$$

that is, the map $\ell: (X, F) \rightarrow (\{\ell_x: x \in X\}, \circ^{n-1})$ defined by $\ell(x) = \ell_x$ is a homomorphism.

The map ℓ defined in the previous proposition enables us to characterize the reducibility of a symmetric n -ary band to a symmetric (binary) band, i.e., a semilattice.

Proposition 3.5. *Let (X, F) be a symmetric n -ary band. The following assertions are equivalent.*

- (i) *The map ℓ is injective.*
- (ii) *The n -ary band (X, F) is isomorphic to $(\{\ell_x: x \in X\}, \circ^{n-1})$.*
- (iii) *The n -ary band (X, F) is an n -ary semilattice.*

Also, the map ℓ enables us to characterize those symmetric n -ary bands that are reducible to Abelian groups. Recall that a group $(X, *)$ with neutral element e has *bounded exponent* if there exists an integer $m \geq 1$ such that the m -fold product $x * \dots * x$ is equal to e for any $x \in X$. In that case, the *exponent* of the group is the smallest integer $m \geq 1$ having this property. Using the characterization of Abelian groups having bounded exponent given by Prüfer and Baer (see [23]), it is straightforward to see that the exponent of an Abelian group divides $n - 1$ if and only if the group is a direct sum of cyclic groups whose orders divide $n - 1$.

Proposition 3.6. *Let (X, F) be a symmetric n -ary band. The following conditions are equivalent.*

- (i) *The map ℓ is constant (i.e., ℓ_x is the identity map on X for any $x \in X$).*
- (ii) *The n -ary band (X, F) is the n -ary extension of a group $(X, *)$ (and in particular $(X, *)$ is Abelian and its exponent divides $n - 1$).*

Now, when the map ℓ associated with F is not injective, it is natural to consider a quotient, and identify the elements of X that have the same image by ℓ . In this context, we have the following result.

Proposition 3.7. *The binary relation \sim on X defined by*

$$x \sim y \iff \ell_x = \ell_y, \quad x, y \in X,$$

is an n -ary semilattice congruence on (X, F) .

Example 3.8. For the structure presented in Example 1.1(a), we have $\ell_3 = \ell_4$ so $[1]_{\sim} = \{1\}$, $[2]_{\sim} = \{2\}$, and $[3]_{\sim} = \{3, 4\}$. The binary reduction of $(X/\sim, \tilde{F}_1)$ is a semilattice whose Hasse diagram is given in Figure 1 (left). For instance, we have

$$[1]_{\sim} \wedge [2]_{\sim} = \tilde{F}_1([1]_{\sim}, [1]_{\sim}, [2]_{\sim}) = [F_1(1, 1, 2)]_{\sim} = [3]_{\sim}.$$

Now, for the structure presented in Example 1.1(b), we only have $\ell_2 = \ell_3$ so $[1]_{\sim} = \{1\}$ and $[2]_{\sim} = \{2, 3\}$. We see that the binary reduction of $(X/\sim, \tilde{F}_2)$ is a semilattice whose Hasse diagram is given in Figure 1 (right).

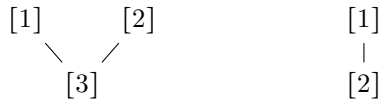

Figure 1: Hasse diagrams of the binary reductions of $(X/\sim, \tilde{F}_1)$ (left) and $(X/\sim, \tilde{F}_2)$ (right)

Since \sim is a congruence for F , this operation restricts to each equivalence class. It is then natural to study the most important properties of this restriction. Using Proposition 3.6, we directly obtain the following result.

Proposition 3.9. *For any $x \in X$, $([x]_{\sim}, F|_{[x]_{\sim}^n})$ is the n -ary extension of an Abelian group whose exponent divides $n - 1$.*

Example 3.10. For both structures presented in Example 1.1, the restrictions of F_1 and F_2 to $[3]_{\sim}^3$ and $[2]_{\sim}^3$, respectively, are isomorphic to the ternary extension of $(\mathbb{Z}_2, +)$.

The congruence \sim enabled us to decompose X as a n -ary semilattice of n -ary semigroups. In order to obtain a strong n -ary semilattice decomposition, we still need to define a suitable family of homomorphisms.

Proposition 3.11. *For every $x, y \in X$ such that $[x]_{\sim} \geq [y]_{\sim}$, the map $\varphi_{[x]_{\sim}, [y]_{\sim}} = \ell_y|_{[x]_{\sim}}$ is a homomorphism from $([x]_{\sim}, F|_{[x]_{\sim}^n})$ to $([y]_{\sim}, F|_{[y]_{\sim}^n})$.*

We can now state our main structure theorem for symmetric n -ary bands.

Theorem 3.12. *An n -ary groupoid (X, F) is a symmetric n -ary band if and only if it is a strong n -ary semilattice of n -ary extensions of Abelian groups whose exponents divide $n - 1$.*

As a direct application of this theorem, we obtain that a symmetric n -ary band is an n -ary group⁵ if and only if it is the n -ary extension of an Abelian group whose exponent divides $n - 1$.

In view of the main result, in order to build symmetric n -ary bands, we have to consider Abelian groups whose exponents divide $n - 1$, and build homomorphisms between the n -ary extensions of such groups. These homomorphisms are described in the next result.

Proposition 3.13. *Let $(X_1, *_1)$ and $(X_2, *_2)$ be two Abelian groups whose exponents divide $n - 1$ and denote by F_1 and F_2 the n -ary extensions of $*_1$ and $*_2$, respectively. For every group homomorphism $\psi: X_1 \rightarrow X_2$ and every $g_2 \in X_2$, the map $h: X_1 \rightarrow X_2$ defined by*

$$h(x) = g_2 *_2 \psi(x), \quad x \in X_1,$$

is a homomorphism of n -ary semigroups.

Conversely, every homomorphism from (X_1, F_1) to (X_2, F_2) is obtained in this way.

4 Reducibility of symmetric n -ary bands

In this section, we use Theorem 3.12 in order to analyze the reducibility problem for symmetric n -ary bands. We thus consider a symmetric n -ary band (X, F) .

Proposition 4.1. *If F is reducible to an associative operation $G: X^2 \rightarrow X$, then the following assertions hold.*

- (i) *G is surjective and symmetric;*
- (ii) *The n -ary semilattice congruence \sim associated with F is a binary semilattice congruence for G .*

It follows from Proposition 4.1 that if F is reducible to G , then G induces an operation $G|_{[x]_{\sim}^2}$ on every equivalence class $[x]_{\sim}$ of X/\sim . This operation is a binary reduction of $F|_{[x]_{\sim}^n}$. Therefore, it is natural to study the properties of the reductions of such operations. This is performed in the following result.

Proposition 4.2. *If (X, F) is the n -ary extension of an Abelian group (X, G_1) whose exponent divides $n - 1$, then every reduction (X, G_2) of F is a group that is isomorphic to (X, G_1) . Moreover, all the reductions of (X, F) are obtained by using (2) with any element e of X .*

We are now able to analyze the reducibility of symmetric n -ary bands.

Proposition 4.3. *A symmetric n -ary band $(X, F) = ((Y, \wedge^{n-1}); (X_\alpha, F_\alpha); \varphi_{\alpha, \beta})$ is reducible to a semigroup if and only if there exists a map $e: Y \rightarrow X$ such that*

- (i) *For every $\alpha \in Y$, $e(\alpha) = e_\alpha$ belongs to X_α ;*
- (ii) *For every $\alpha, \beta \in Y$ such that $\alpha \geq \beta$, we have $\varphi_{\alpha, \beta}(e_\alpha) = e_\beta$.*

Moreover, when (X, F) is reducible to a semigroup, a reduction is given by the semigroup decomposed as $((Y, \wedge^{n-1}); (X_\alpha, G_\alpha); \varphi_{\alpha, \beta})$, where G_α is the reduction of F_α with respect to e_α .

Example 4.4. For the structures of Example 1.1(a) and (b), respectively, the only non obvious homomorphisms are given by $\varphi_{[1]_{\sim}, [3]_{\sim}} = \ell_3|_{[1]_{\sim}}$, $\varphi_{[2]_{\sim}, [3]_{\sim}} = \ell_3|_{[2]_{\sim}}$, and $\varphi_{[1]_{\sim}, [2]_{\sim}} = \ell_2|_{[1]_{\sim}}$, respectively.

- For (X, F_1) , we have $\varphi_{[1]_{\sim}, [3]_{\sim}}(1) = \ell_3(1) = 4$ and $\varphi_{[2]_{\sim}, [3]_{\sim}}(2) = \ell_3(2) = 3$.
- For (X, F_2) , we have $\varphi_{[1]_{\sim}, [2]_{\sim}}(1) = \ell_2(1) = 2$.

⁵Recall that an n -ary group is an n -ary semigroup (X, F) such that for any $i \in \{1, \dots, n\}$ and any $x_1, \dots, x_{i-1}, x_{i+1}, \dots, x_n, y \in X$ there exists a unique $z \in X$ such that $F(x_1, \dots, x_{i-1}, z, x_{i+1}, \dots, x_n) = y$.

By Proposition 3.13 these are homomorphisms from the ternary extension of the trivial group to the ternary extension of $(\mathbb{Z}_2, +)$. It is easy to see that (X, F_1) and (X, F_2) , respectively, are the strong ternary semilattices associated with the semilattices whose Hasse diagrams are depicted in Figure 1 (left) and (right), respectively, and the ternary extensions of groups and homomorphisms given here. It follows from Theorem 3.12 that (X, F_1) and (X, F_2) are symmetric ternary bands. Finally, we can use Proposition 4.3 to analyze the reducibility problem for (X, F_1) and (X, F_2) .

1. For (X, F_1) we must have $e([1]_{\sim}) = 1$ and $e([2]_{\sim}) = 2$. Then we must have $e([3]_{\sim}) = \varphi_{[1]_{\sim}, [3]_{\sim}}(1) = 4$ but also $e([3]_{\sim}) = \varphi_{[2]_{\sim}, [3]_{\sim}}(2) = 3$, a contradiction. So (X, F_1) is not reducible to a semigroup.
2. For (X, F_2) the map e defined by $e([1]_{\sim}) = 1$ and $e([2]_{\sim}) = 2$ satisfies the conditions of Proposition 4.3 and so (X, F_2) is reducible to a semigroup (X, G) . The operation table of G is given below.

G	1	2	3
1	1	2	3
2	2	2	3
3	3	3	2

Acknowledgments

The first author is supported by the Luxembourg National Research Fund under the project PRIDE 15/10949314/GSM.

References

- [1] Nathanael L. Ackerman. A characterization of quasitrivial n -semigroups. To appear in *Algebra Universalis*.
- [2] Alfred H. Clifford. Bands of semigroups, *Proc. Amer. Math. Soc.*, 5, 499–504, 1954.
- [3] Alfred H. Clifford and Gordon B. Preston. *The algebraic theory of semigroups*. American Mathematical Society, Vol. 1, 1961.
- [4] Miguel Couceiro and Jimmy Devillet. Every quasitrivial n -ary semigroup is reducible to a semigroup. *Algebra Universalis*, 80(4), 2019.
- [5] Miguel Couceiro, Jimmy Devillet, Jean-Luc Marichal, and Pierre Mathonet. Reducibility of n -ary semigroups: from quasitriviality towards idempotency. Submitted for publication. *arXiv preprint arXiv:1909.10412*, 2019.
- [6] Jimmy Devillet, Gergely Kiss, and Jean-Luc Marichal. Characterizations of quasitrivial symmetric nondecreasing associative operations. *Semigroup Forum*, 98(1), 154–171, 2019.
- [7] Jimmy Devillet and Pierre Mathonet. On the structure of symmetric n -ary bands. Submitted for publication. *arXiv preprint arXiv:2004.12423* 2020.
- [8] Wiśław A. Dudek and Vladimir V. Mukhin. On n -ary semigroups with adjoint neutral element. *Quasigroups and Related Systems*, 14:163–168, 2006.
- [9] Wilhelm Dörnte. Untersuchungen über einen verallgemeinerten Gruppenbegriff. *Math. Z.*, 29:1–19, 1928.
- [10] Pierre A. Grillet. *Commutative semigroups*. Springer, Boston, MA, 2001.
- [11] Jerzy W. Grzymala-Busse. Automorphisms of polyadic automata. *J. Assoc. Comput. Mach.*, 16:208–219, 1969.
- [12] John M. Howie. *Fundamentals of semigroup theory*. Oxford University Press, 1995.
- [13] Gergely Kiss and Gabor Somlai. Associative idempotent nondecreasing functions are reducible. *Semigroup Forum*, 98(1), 140–153, 2019.
- [14] Kenneth Krohn and John Rhodes. Algebraic theory of machines. I. Prime decomposition theorem for finite semigroups and machines. *Trans. Amer. Math. Soc.*, 116, 450–464, 1965.
- [15] Helmut Länger. The free algebra in the variety generated by quasi-trivial semigroups. *Semigroup Forum*, 20:151–156, 1980.
- [16] Charles F. Laywine and Gary L. Mullen. *Discrete mathematics using latin squares*. Wiley, New York, 1998.
- [17] Charles F. Laywine, Gary L. Mullen, and Geoff Whittle. D -dimensional hypercubes and the Euler and MacNeish conjectures. *Montsh. Math.*, 111:223–238, 1995.
- [18] Erkki Lehtonen and Florian Starke. On associative operations on commutative integral domains. *Semigroup Forum*, 100(3), 910–915, 2020.

- [19] David McLean. Idempotent semigroups. *Amer. Math. Monthly*, 61:110–113, 1954.
- [20] Mario Petrich. Introduction to semigroups. Charles E. Merrill, 1973.
- [21] Mario Petrich. Lectures in semigroups. John Wiley, London, 1977.
- [22] Emil L. Post. Polyadic groups. *Trans. Amer. Math. Soc.*, 48:208–350, 1940.
- [23] Joseph J. Rotman, *An Introduction to the Theory of Groups*. 4th Ed. Springer-Verlag, New York, USA, 1995.

LINEARLY DEFINABLE CLASSES OF BOOLEAN FUNCTIONS*

Miguel Couceiro

Université de Lorraine, CNRS, Inria, LORIA
F-54000 Nancy, France
miguel.couceiro@loria.fr

Erkko Lehtonen

Centro de Matemática e Aplicações
Faculdade de Ciências e Tecnologia
Universidade Nova de Lisboa, Portugal
e.lehtonen@fct.unl.pt

Dedicated to Maurice Pouzet on the occasion of his 75th birthday

ABSTRACT

In this paper we address the question “How many properties of Boolean functions can be defined by means of linear equations?” It follows from a result by Sparks that there are countably many such linearly definable classes of Boolean functions. In this paper, we refine this result by completely describing these classes. This work is tightly related with the theory of function minors and stable classes, a topic that has been widely investigated in recent years by several authors including Maurice Pouzet.

Keywords Functional equation · linear definability · clone · clonoid · Boolean function

1 Introduction and motivation

Functional equations are universally quantified first-order sentences in a certain algebraic syntax, with a single function symbol and no other predicate symbol than equality. More precisely, a *functional equation* for a function of several arguments from A to B is a formal expression

$$h_1(\mathbf{f}(g_1(\mathbf{v}_1, \dots, \mathbf{v}_p)), \dots, \mathbf{f}(g_m(\mathbf{v}_1, \dots, \mathbf{v}_p))) = h_2(\mathbf{f}(g'_1(\mathbf{v}_1, \dots, \mathbf{v}_p)), \dots, \mathbf{f}(g'_t(\mathbf{v}_1, \dots, \mathbf{v}_p))), \quad (1)$$

where $m, t, p \geq 1$, $h_1: B^m \rightarrow C$, $h_2: B^t \rightarrow C$, each g_i and g'_j is a map $A^p \rightarrow A$, the $\mathbf{v}_1, \dots, \mathbf{v}_p$ are p distinct symbols called *vector variables*, and \mathbf{f} is a distinct symbol called *function symbol*. An n -ary function $f: A^n \rightarrow B$ is said to *satisfy* the equation (1) if, for all $\mathbf{a}_1, \dots, \mathbf{a}_p \in A^n$, we have

$$h_1(f(g_1(\mathbf{a}_1, \dots, \mathbf{a}_p)), \dots, f(g_m(\mathbf{a}_1, \dots, \mathbf{a}_p))) = h_2(f(g'_1(\mathbf{a}_1, \dots, \mathbf{a}_p)), \dots, f(g'_t(\mathbf{a}_1, \dots, \mathbf{a}_p))),$$

where the g_i and g'_j are applied componentwise. Well-known examples of functional properties definable by such functional equations include the linearity property of functions over fields, the monotonicity and convexity properties that are typically expressed by functional inequalities.

Such functional equations regained interest in 2000, due to the work of Ekin, Foldes, Hammer, and Hellerstein [8] who showed that the equational classes of Boolean functions are exactly those classes that are closed under introduction of fictitious variables, and identification and permutation of variables. These operations on functions give rise to a preorder on functions, the so-called *simple minor* relation, and equational classes are exactly the “initial segments” for this preorder [3, 7]. Alternatively, these classes appear naturally in a Galois theory proposed by Pippenger [18] that is based on the preservation relation between functions and relation pairs (also called “relational constraints”). Using this framework it was shown that, even in the case of Boolean functions, there are uncountably many classes of functions definable by functional equations. For instance, all Post’s classes (clones of Boolean functions), traditionally characterized by relations, are definable by functional equations.

*This work is funded by National Funds through the FCT – Fundação para a Ciência e a Tecnologia, I.P., under the scope of the project UIDB/00297/2020 (Center for Mathematics and Applications).

This motivated several studies that considered syntactic restrictions on functional equations and relational constraints. Foldes and Pogosyan [10] considered a variant, the so-called *functional terms*, to define all Boolean clones and to give a criterion to determine whether a clone is finitely definable. In [4] the authors focused on linear equations and showed that the classes of Boolean functions definable by linear equations are exactly those that are stable under left and right compositions with the clone of constant-preserving linear functions or, equivalently, definable by affine constraints. This was later extended to arbitrary functions over fields [5], and to stability under compositions with arbitrary clones [6]: an equational class is definable by relation pairs in which the two relations are invariant for clones C_1 and C_2 , respectively, if and only if the class is stable under left composition with C_1 and under right composition with C_2 (in short, (C_1, C_2) -stable). Instances of the idea of (C_1, C_2) -stability are present in various studies. The initial segments of so-called C -minor quasiorders, systematically studied in [12, 13, 14, 15, 16, 17], are exactly such (C_1, C_2) -stable classes where the first clone C_1 is the clone of projections. On the other hand, when C_2 is the clone of projections, we get clonoids, as studied by Aichinger, Mayr, and others [1, 2, 21]. The case when both C_1 and C_2 are clones of projections corresponds to minor-closed classes. As an example of recent work on (C_1, C_2) -stable classes that is closely related with the current paper, we would like to mention studies of function classes stable under left and right compositions with clones of linear functions by Fioravanti and Kreinecker [9, 11].

Getting back to linearly definable classes of Boolean functions, in [5] it was observed that, for each integer $k \geq 0$, the class of Boolean functions whose degree is upper bounded by k is definable by the following linear equation:

$$\sum_{I \subseteq \{1, \dots, k+1\}} \mathbf{f}(\sum_{i \in I} \mathbf{v}_i) = 0.$$

This shows that even in the case of Boolean functions, there are infinitely many linearly definable classes. Other examples were also provided, but it remained until recently an open problem to determine whether there are uncountably many linearly definable classes as is the case with classes definable by unrestricted functional equations. The answer follows from a result of Sparks [21, Theorem 1.3], namely, there are a countably infinite number of linearly definable classes.

In this paper we refine this result by explicitly describing the linearly definable classes of Boolean functions. After recalling some basic notions and results on function minors and stability under composition with clones in Section 2, we then completely describe the lattice of linearly definable classes (Section 3). Using this result and Post's classification of Boolean clones, we can easily determine the classes which are stable under right and left compositions with clones C_1 and C_2 containing the clone of constant-preserving linear functions (Section 4).

2 Basic notions and preliminary results

Throughout this paper, let \mathbb{N} and \mathbb{N}_+ denote the set of all nonnegative integers and the set of all positive integers, respectively. For any $n \in \mathbb{N}$, the symbol $[n]$ denotes the set $\{i \in \mathbb{N} \mid 1 \leq i \leq n\}$.

Let A and B be sets. A mapping of the form $f: A^n \rightarrow B$ for some $n \in \mathbb{N}_+$ is called a *function of several arguments from A to B* (or simply a *function*). The number n is called the *arity* of f and denoted by $\text{ar}(f)$. If $A = B$, then such a function is called an *operation on A* . We denote by \mathcal{F}_{AB} and \mathcal{O}_A the set of all functions of several arguments from A to B and the set of all operations on A , respectively. For any $n \in \mathbb{N}_+$, we denote by $\mathcal{F}_{AB}^{(n)}$ the set of all n -ary functions in \mathcal{F}_{AB} , and for any $C \subseteq \mathcal{F}_{AB}$, we let $C^{(n)} := C \cap \mathcal{F}_{AB}^{(n)}$ and call it the *n -ary part of C* .

Example 2.1. For $b \in B$ and $n \in \mathbb{N}$, the n -ary constant function $c_b^{(n)}: A^n \rightarrow B$ is given by the rule $(a_1, \dots, a_n) \mapsto b$ for all $a_1, \dots, a_n \in A$.

Example 2.2. In the case when $A = B$, for $n \in \mathbb{N}$ and $i \in [n]$, the i -th n -ary projection $\text{pr}_i^{(n)}: A^n \rightarrow A$ is given by the rule $(a_1, \dots, a_n) \mapsto a_i$ for all $a_1, \dots, a_n \in A$.

Let $f: A^n \rightarrow B$ and $i \in [n]$. The i -th argument is *essential* in f if there exist $a_1, \dots, a_n, a'_i \in A$ such that

$$f(a_1, \dots, a_n) \neq f(a_1, \dots, a_{i-1}, a'_i, a_{i+1}, \dots, a_n).$$

An argument that is not essential is *fictitious*.

2.1 Minors and functional composition

Let $f: B^n \rightarrow C$ and $g_1, \dots, g_n: A^m \rightarrow B$. The *composition* of f with g_1, \dots, g_n is the function $f(g_1, \dots, g_n): A^m \rightarrow C$ given by the rule

$$f(g_1, \dots, g_n)(\mathbf{a}) := f(g_1(\mathbf{a}), \dots, g_n(\mathbf{a})), \quad \text{for all } \mathbf{a} \in A^m.$$

Let $\sigma: [n] \rightarrow [m]$. Define the function $f_\sigma: A^m \rightarrow B$ by the rule

$$f_\sigma(a_1, \dots, a_m) = f(a_{\sigma(1)}, \dots, a_{\sigma(n)}),$$

for all $a_1, \dots, a_m \in A$. Such a function f_σ is called a *minor* of f . Intuitively, minors of f are all those functions that can be obtained from f by manipulation of its arguments: permutation of arguments, introduction of fictitious arguments, identification of arguments. It is clear from the definition that the minor f_σ can be obtained as a composition of f with m -ary projections on A :

$$f_\sigma = f(\text{pr}_{\sigma(1)}^{(m)}, \dots, \text{pr}_{\sigma(n)}^{(m)}).$$

We write $f \leq g$ if f is a minor of g . The minor relation \leq is a quasiorder (a reflexive and transitive relation) on \mathcal{F}_{AB} , and it induces an equivalence relation \equiv on \mathcal{F}_{AB} and a partial order on the quotient \mathcal{F}_{AB}/\equiv in the usual way: $f \equiv g$ if $f \leq g$ and $g \leq f$, and $f/\equiv \leq g/\equiv$ if $f \leq g$.

Functional composition can be extended to classes of functions. Let $C \subseteq \mathcal{F}_{BC}$ and $K \subseteq \mathcal{F}_{AB}$. The *composition* of C with K is defined as

$$CK := \{f(g_1, \dots, g_n) \mid f \in C^{(n)}, g_1, \dots, g_n \in K^{(m)}, n, m \in \mathbb{N}_+\}.$$

It follows immediately from definition that function class composition is monotone, i.e., if $C, C' \subseteq \mathcal{F}_{BC}$ and $K, K' \subseteq \mathcal{F}_{AB}$ satisfy $C \subseteq C'$ and $K \subseteq K'$, then $CK \subseteq C'K'$.

2.2 Clones, minor closure and stability under compositions with clones

A class $C \subseteq \mathcal{O}_A$ is called a *clone* on A if $CC \subseteq C$ and C contains all projections. The set of all clones on A is a closure system in which the greatest and least elements are the clone \mathcal{O}_A of all operations on A and the clone of all projections on A , respectively.

Definition 2.3. Let $K \subseteq \mathcal{F}_{AB}$, $C_1 \subseteq \mathcal{O}_B$, and $C_2 \subseteq \mathcal{O}_A$. We say that K is *stable under left composition* with C_1 if $C_1K \subseteq K$, and that K is *stable under right composition* with C_2 is $KC_2 \subseteq K$. If both $C_1K \subseteq K$ and $KC_2 \subseteq K$ hold, we say that K is (C_1, C_2) -*stable*. If $K, C \subseteq \mathcal{O}_A$ and K is (C, C) -stable, we say that K is C -*stable*. The set of all (C_1, C_2) -stable subsets of \mathcal{F}_{AB} is a closure system.

Remark 2.4. A set $K \subseteq \mathcal{F}_{AB}$ is minor-closed if and only if it is stable under right composition with the set of all projections on A . Every clone is minor-closed. A clone C is (C, C) -stable.

Lemma 2.5. Let C_1 and C'_1 be clones on B and C_2 and C'_2 clones on A such that $C_1 \subseteq C'_1$ and $C_2 \subseteq C'_2$. Then for every $K \subseteq \mathcal{F}_{AB}$, it holds that if K is (C'_1, C'_2) -stable then K is (C_1, C_2) -stable.

Proof. Assume that K is (C'_1, C'_2) -stable. It follows from the monotonicity of function class composition that

$$C_1K \subseteq C'_1K \subseteq K \quad \text{and} \quad KC_2 \subseteq KC'_2 \subseteq K.$$

In other words, K is (C_1, C_2) -stable. □

3 The lattice of linearly definable classes of Boolean functions

Recall that operations on $\{0, 1\}$ are called *Boolean functions*. In this section we completely describe the lattice of linearly definable classes of Boolean functions. The starting point is the following characterization of these classes first obtained for Boolean functions in [4], and later extended to classes of functions defined on $\{0, 1\}$ and valued in rings [6].

Theorem 3.1. *A class of Boolean functions is linearly definable if and only if it is stable under left and right compositions with the clone of constant-preserving linear Boolean functions.*

Hence to completely describe the linearly definable classes it suffices to determine those that are stable under left and right compositions with the clone of constant-preserving linear Boolean functions. This will be presented in Subsection 3.2.

3.1 Some special classes of Boolean functions

The class of all Boolean functions is denoted by Ω . It is well known that every $f \in \Omega^{(n)}$ is represented by a unique multilinear polynomial over the two-element field, i.e., a polynomial with coefficients in $\{0, 1\}$ in which no variable

appears with an exponent greater than 1. This polynomial is known as the *Zhegalkin polynomial* of f , and it can be written as

$$f = \sum_{S \in M_f} x_S,$$

where x_S is a shorthand for $\prod_{i \in S} x_i$ and where $M_f \subseteq \mathcal{P}([n])$ is the family of index sets corresponding to the monomials of f . Note that $x_\emptyset = 1$ and $\sum_{S \in \emptyset} x_S = 0$. The terms x_S with $S \neq \emptyset$ are called *monomials*. If $\emptyset \in M_f$, then we say that f has *constant term 1*; otherwise f has *constant term 0*. Without any risk of confusion, we will often denote functions by their Zhegalkin polynomials, and we refer to the set M_f as the *set of monomials* of f .

The *degree* of a Boolean function f , denoted $\deg(f)$, is the size of the largest monomial of f , i.e.,

$$\deg(f) := \max_{S \in M_f} |S|$$

for $f \neq 0$, and we agree that $\deg(0) := 0$. For $k \in \mathbb{N}$, we denote by D_k the class of all Boolean functions of degree at most k . Clearly $D_k \subsetneq D_{k+1}$ for all $k \in \mathbb{N}$. A Boolean function f is *linear* if $\deg(f) \leq 1$.² We denote by L the class of all linear functions. Thus $L = D_1$.

For $a \in \{0, 1\}$, let $C_a := \{f \in \Omega \mid f(0, \dots, 0) = a\}$ and $E_a := \{f \in \Omega \mid f(1, \dots, 1) = a\}$. Clearly $C_0 \cap C_1 = \emptyset$ and $C_0 \cup C_1 = \Omega$; similarly, $E_0 \cap E_1 = \emptyset$ and $E_0 \cup E_1 = \Omega$. It is easy to see that C_a is the class of all Boolean functions with constant term a .

For $a \in \{0, 1\}$, a Boolean function f is *a-preserving* if $f(a, \dots, a) = a$. A function is *constant-preserving* if it is both 0- and 1-preserving. We denote the classes of all 0-preserving, of all 1-preserving, and of all constant-preserving functions by T_0 , T_1 , and T_c , respectively. Note that $T_c = T_0 \cap T_1$. It follows from the definitions that $T_0 = C_0$, $T_1 = E_1$, and $T_c = C_0 \cap E_1$.

Remark 3.2. The reason why we have introduced multiple notation for the classes $T_0 = C_0$ and $T_1 = E_1$ is to facilitate writing certain statements in a parameterized form and to make reference, as the case may be, to either the classes C_a ($a \in \{0, 1\}$), E_a ($a \in \{0, 1\}$), or T_a ($a \in \{0, 1\}$).

The *parity* of a Boolean function f , denoted $\text{par}(f)$, is a number, either 0 or 1, which is given by

$$\text{par}(f) := |M_f \setminus \{\emptyset\}| \bmod 2.$$

We call a function *even* or *odd* if its parity is 0 or 1, respectively. We denote by P_0 and P_1 the classes of all even and of all odd functions, respectively. Clearly $P_0 \cap P_1 = \emptyset$ and $P_0 \cup P_1 = \Omega$.

For $a \in \{0, 1\}$, let \bar{a} denote the *negation* of a , that is, $\bar{a} := 1 - a$. A function f is *self-dual* if

$$f(a_1, \dots, a_n) = \overline{f(\bar{a}_1, \dots, \bar{a}_n)}, \quad \text{for all } a_1, \dots, a_n \in \{0, 1\}.$$

A function f is *reflexive* (or *self-anti-dual*) if $f(a_1, \dots, a_n) = f(\bar{a}_1, \dots, \bar{a}_n)$ for all $a_1, \dots, a_n \in \{0, 1\}$. We denote by S the class of all self-dual functions. Let $S_c := S \cap T_c$, the class of constant-preserving self-dual functions.

We also let $L_0 := L \cap T_0$, $L_1 := L \cap T_1$, $LS := L \cap S$, and $L_c := L \cap T_c$. It is easy to verify that $L_0 = L \cap C_0$, $L_1 = (L \cap P_0 \cap C_1) \cup (L \cap P_1 \cap C_0)$, $L_c = L \cap P_1 \cap C_0$, and $LS = L \cap P_1$.

It was shown by Post [19] that there are a countably infinite number of clones of Boolean functions. In this paper, we will only need a handful of them, namely the clones Ω , T_0 , T_1 , T_c , S , S_c , L , L_0 , L_1 , LS , and L_c that were defined above.

Let f be an n -ary Boolean function. The *characteristic* of a set $S \subseteq [n]$ in f is given by

$$\text{ch}(S, f) := |\{A \in M_f \mid S \subsetneq A\}| \bmod 2.$$

The *characteristic rank* of f , denoted by $\chi(f)$, is the smallest integer m such that $\text{ch}(S, f) = 0$ for all subsets $S \subseteq [n]$ with $|S| \geq m$. Clearly, $\chi(f) \leq n$ because $\text{ch}([n], f) = 0$. For $k \in \mathbb{N}$, denote by X_k the class of all Boolean functions of characteristic rank at most k . For any $k \in \mathbb{N}$, we have $X_k \subsetneq X_{k+1}$. The inclusion is proper, as witnessed by the function $x_1 \dots x_{k+1} \in X_{k+1} \setminus X_k$. Moreover, for any $k \in \mathbb{N}$, we have $D_k \subseteq X_k$.

Reflexive and self-dual functions have a beautiful characterization in terms of the characteristic rank.

Lemma 3.3 (Selezneva, Bukhman [20, Lemmata 3.1, 3.5]).

1. A Boolean function f is reflexive if and only if $\chi(f) = 0$.

²Strictly speaking, functions of degree at most 1 are *affine* in the sense of linear algebra. We go along with the term *linear* that is common in the context of clone theory and especially in the theory of Boolean functions.

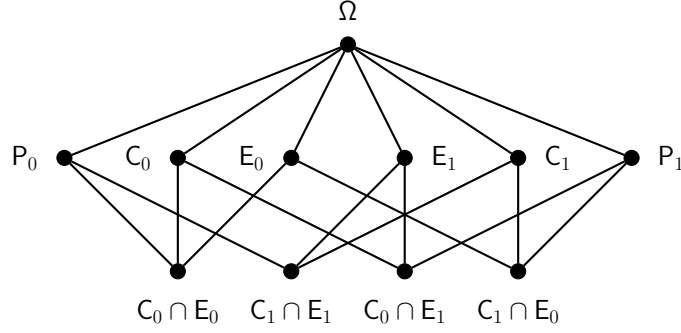

Figure 1: A block of eleven L_c -stable classes.

2. A Boolean function f is self-dual if and only if $f + x_1$ is reflexive.
3. A Boolean function f is self-dual if and only if f is odd and $\chi(f) = 1$.

In other words, $X_0 = X_1 \cap P_0$ is the class of all reflexive functions, $X_1 \cap P_1$ is the class of all self-dual functions, and X_1 is the class of all self-dual or reflexive functions.

3.2 L_c -stable classes

We can now present the main result of the paper, namely, a complete description of the L_c -stable classes or, equivalently, of the linearly definable classes of Boolean functions. Of particular importance is the poset of the eleven classes Ω , P_0 , P_1 , C_0 , C_1 , E_0 , E_1 , $C_0 \cap E_0$, $C_0 \cap E_1$, $C_1 \cap C_0$, $C_1 \cap E_1$ that is shown in Figure 1. It is noteworthy that the four minimal classes of this poset are pairwise disjoint, and that the six lower covers of Ω are precisely the unions of the six different pairs of minimal classes.

Theorem 3.4. *The L_c -stable classes are*

Ω ,	C_a ,	E_a ,	P_a ,	$C_a \cap E_b$,
D_k ,	$D_k \cap C_a$,	$D_k \cap E_a$,	$D_k \cap P_a$,	$D_k \cap C_a \cap E_b$,
X_k ,	$X_k \cap C_a$,	$X_k \cap E_a$,	$X_k \cap P_a$,	$X_k \cap C_a \cap E_b$,
$D_i \cap X_j$,	$D_i \cap X_j \cap C_a$,	$D_i \cap X_j \cap E_a$,	$D_i \cap X_j \cap P_a$,	$D_i \cap X_j \cap C_a \cap E_b$,
D_0 ,	$D_0 \cap C_a$,	\emptyset ,		

for $a, b \in \{0, 1\}$ and $i, j, k \in \mathbb{N}_+$ with $i > j \geq 1$.

The lattice of L_c -stable classes is shown in Figure 2. In order to avoid clutter, we have used some shorthand notation. The diagram includes multiple copies of the 11-element poset of Figure 1 (the shaded blocks) connected by thick triple lines. Each thick triple line between a pair of such blocks represents eleven edges, each connecting a vertex of one poset to its corresponding vertex in the other poset. We have labeled in the diagram the meet-irreducible classes, as well as a few other classes of interest; the remaining classes are intersections of the meet-irreducible ones.

The proof of Theorem 3.4 is omitted for space constraints. The proof has two parts. First we need to verify that the classes listed in Theorem 3.4 are L_c -stable. Since intersections of L_c -stable classes are L_c -stable, it suffices to show this for the meet-irreducible classes; this is rather straightforward. Secondly, we need to verify that there are no other L_c -stable classes. This is a more difficult task and can be accomplished by proving that each class K is generated by any subset of K that contains for each proper subclass C of K an element in $K \setminus C$.

4 Stability under clones containing L_c

Using Theorem 3.4 together with Lemma 2.5 it is straightforward to determine the (C_1, C_2) -stable classes for any clones C_1 and C_2 containing L_c . Such classes must occur among the L_c -stable classes by Lemma 2.5, so it is just a matter of deciding which ones are (C_1, C_2) -stable. In particular, we obtain the C -stable classes for every clone C containing L_c , i.e., the clones Ω , T_0 , T_1 , T_c , S , S_c , L , L_0 , L_1 , LS and L_c .

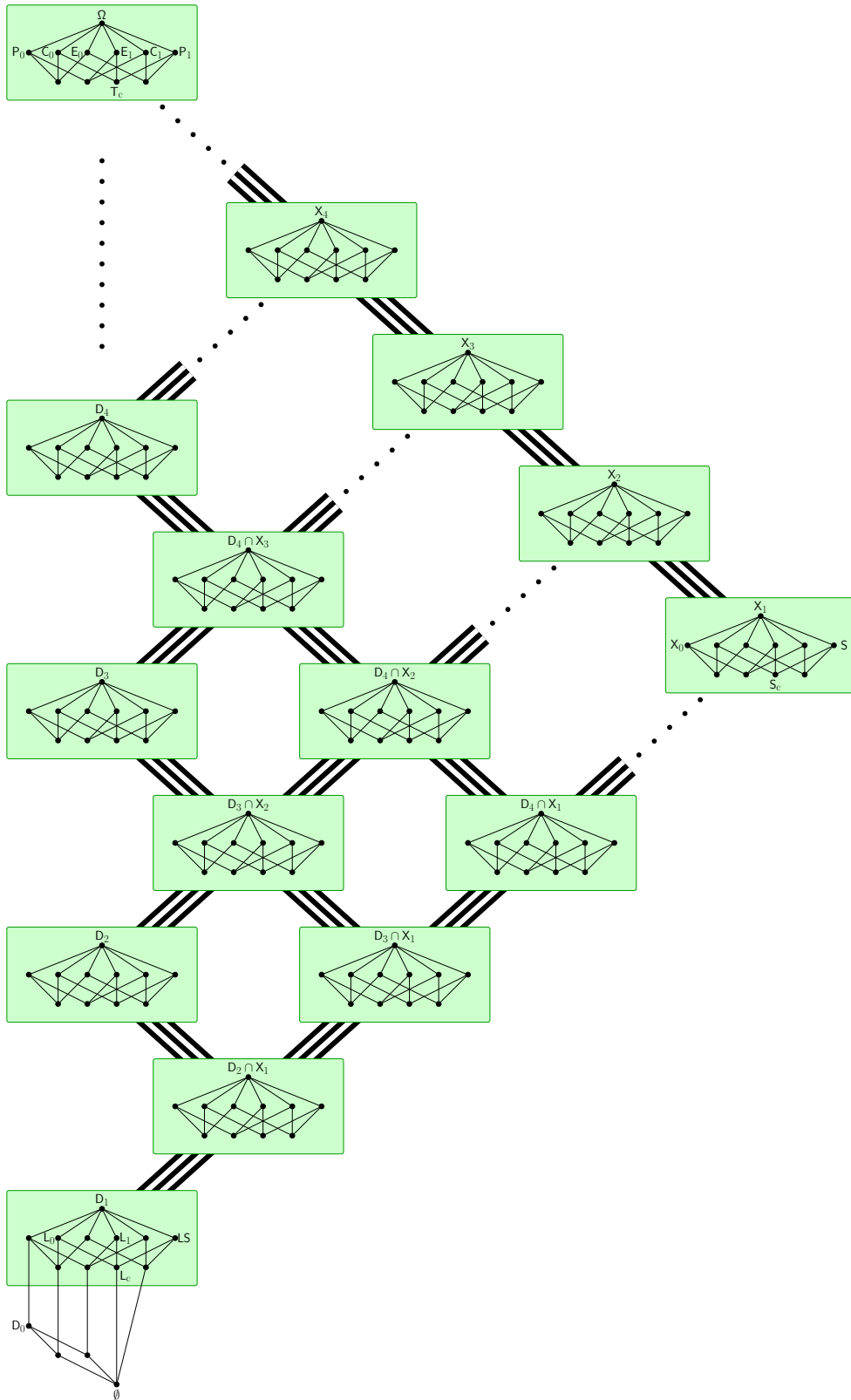

Figure 2: L_c -stable classes.

Theorem 4.1.

- (i) The L_c -stable classes are $\Omega, C_a, E_a, P_a, C_a \cap E_b, D_k, D_k \cap C_a, D_k \cap E_a, D_k \cap P_a, D_k \cap C_a \cap E_b, X_k, X_k \cap C_a, X_k \cap E_a, X_k \cap P_a, X_k \cap C_a \cap E_b, D_i \cap X_j, D_i \cap X_j \cap C_a, D_i \cap X_j \cap E_a, D_i \cap X_j \cap P_a, D_i \cap X_j \cap C_a \cap E_b, D_0, D_0 \cap C_a, \emptyset$, for $a, b \in \{0, 1\}$ and $i, j, k \in \mathbb{N}_+$ with $i > j \geq 1$.
- (ii) The LS -stable classes are $\Omega, X_k, X_1 \cap P_a, D_k, D_1 \cap P_a, D_i \cap X_j, D_i \cap X_1 \cap P_a, D_0, \emptyset$, for $a \in \{0, 1\}$ and $i, j, k \in \mathbb{N}_+$ with $i > j \geq 1$.
- (iii) The L_0 -stable classes are $\Omega, C_0, D_k, D_k \cap C_0, D_0, D_0 \cap C_0, \emptyset$, for $k \in \mathbb{N}_+$.
- (iv) The L_1 -stable classes are $\Omega, E_1, D_k, D_k \cap E_1, D_0, D_0 \cap C_1, \emptyset$, for $k \in \mathbb{N}_+$.
- (v) The L -stable classes are $\Omega, D_k, D_0, \emptyset$, for $k \in \mathbb{N}_+$.
- (vi) The S_c -stable classes are $\Omega, C_a, E_a, P_a, C_a \cap E_b, X_1 \cap P_a, X_1 \cap C_a \cap E_b, D_0, D_0 \cap C_a, \emptyset$, for $a, b \in \{0, 1\}$.
- (vii) The S -stable classes are $\Omega, X_1 \cap P_a, D_0, \emptyset$, for $a \in \{0, 1\}$.
- (viii) The T_c -stable classes are $\Omega, C_a, E_a, P_0, C_a \cap E_b, D_0, D_0 \cap C_a, \emptyset$, for $a, b \in \{0, 1\}$.
- (ix) The T_0 -stable classes are $\Omega, C_0, D_0, D_0 \cap C_0, \emptyset$.
- (x) The T_1 -stable classes are $\Omega, E_1, D_0, D_0 \cap C_1, \emptyset$.
- (xi) The Ω -stable classes are Ω, D_0, \emptyset .

References

- [1] Erhard Aichinger and Peter Mayr. Finitely generated equational classes. *J. Pure Appl. Algebra* **220** (2016) 2816–2827.
- [2] Erhard Aichinger and Bernardo Rossi. A clonoid based approach to some finiteness results in universal algebraic geometry. *Algebra Universalis* **81**(1) (2020), Paper No. 8, 7 pp.
- [3] Moncef Bouaziz, Miguel Couceiro, and Maurice Pouzet. Join-irreducible Boolean functions. *Order* **27** (2010) 261–282.
- [4] Miguel Couceiro and Stephan Foldes. Definability of Boolean function classes by linear equations over $\text{GF}(2)$. *Discrete Appl. Math.* **142** (2004) 29–34.
- [5] Miguel Couceiro and Stephan Foldes. Functional equations, constraints, definability of function classes, and functions of Boolean variables. *Acta Cybernet.* **18** (2007) 61–75.
- [6] Miguel Couceiro and Stephan Foldes. Function classes and relational constraints stable under compositions with clones. *Discuss. Math. Gen. Algebra Appl.* **29** (2009) 109–121.
- [7] Miguel Couceiro and Maurice Pouzet. On a quasi-ordering on Boolean functions. *Theoret. Comput. Sci.* **396** (2008) 71–87.
- [8] Oya Ekin, Stephan Foldes, Peter L. Hammer, and Lisa Hellerstein. Equational characterizations of Boolean function classes. *Discrete Math.* **211** (2000) 27–51.
- [9] Stefano Fioravanti. Closed sets of finitary functions between finite fields of coprime order. arXiv:1910.11759.
- [10] Stephan Foldes and Grant R. Pogosyan. Post classes characterized by functional terms. *Discrete Appl. Math.* **142** (2004) 35–51.
- [11] Sebastian Kreinecker. Closed function sets on groups of prime order. *J. Mult.-Valued Logic Soft Comput.* **33** (2019) 51–74.
- [12] Erkkö Lehtonen. Descending chains and antichains of the unary, linear, and monotone subfunction relations. *Order* **23** (2006) 129–142.
- [13] Erkkö Lehtonen and Jaroslav Nešetřil. Minors of Boolean functions with respect to clique functions and hypergraph homomorphisms. *European J. Combin.* **31** (2010) 1981–1995.
- [14] Erkkö Lehtonen and Ágnes Szendrei. Equivalence of operations with respect to discriminator clones. *Discrete Math.* **309** (2009) 673–685.

- [15] Erkkö Lehtonen and Ágnes Szendrei. The submaximal clones on the three-element set with finitely many relative \mathcal{R} -classes. *Discuss. Math. Gen. Algebra Appl.* **30** (2010) 7–33.
- [16] Erkkö Lehtonen and Ágnes Szendrei. Clones with finitely many relative \mathcal{R} -classes. *Algebra Universalis* **65** (2011) 109–159.
- [17] Erkkö Lehtonen and Ágnes Szendrei. Partial orders induced by quasilinear clones. In *Contributions to General Algebra 20*, Proceedings of the Salzburg Conference 2011 (AAA81), pages 51–84. Verlag Johannes Heyn, Klagenfurt, 2012.
- [18] Nicholas Pippenger. Galois theory for minors of finite functions. *Discrete Math.* **254** (2002) 405–419.
- [19] Emil L. Post. *The Two-Valued Iterative Systems of Mathematical Logic*. Annals of Mathematics Studies, no. 5. Princeton University Press, Princeton, 1941.
- [20] Svetlana N. Selezneva and Anton V. Bukhman. Polynomial-time algorithms for checking some properties of Boolean functions given by polynomials. *Theory Comput. Syst.* **58** (2016) 383–391.
- [21] Athena Sparks. On the number of clonoids. *Algebra Universalis* **80**(4) (2019), Paper No. 53, 10 pp.

COMBINATORIAL INTERPRETATION OF BI^sNOMIAL COEFFICIENTS AND GENERALIZED CATALAN NUMBERS

Hacène Belbachir
 Faculty of Mathematics
 USTHB, RECITS Laboratory, CATI Team
 B.P. 32, El Alia, 16111, Bab Ezzouar, Algeria.
 hacenebelbachir@gmail.com

Oussama Igueroufa
 Faculty of Mathematics
 USTHB, RECITS Laboratory, CATI Team
 B.P. 32, El Alia, 16111, Bab Ezzouar, Algeria.
 igueroufa.oussama@gmail.com

ABSTRACT

We provide a combinatorial interpretation of bi^snomial coefficients, by using paths that lie on hypergrids. We also give a generalization of Catalan numbers, called as *s*-Catalan, through using *s*-Pascal triangle. Two identities of *s*-Catalan numbers are derived.

Keywords Bi^snomial coefficients · *s*-Pascal triangle · Generalized Pascal Formula · Hypergrids · *s*-Catalan numbers.

1 Introduction

Bi^snomial coefficients were introduced for the first time in 1730, by Abraham de Moivre [7], in his study to answer to the following question: "Considering *L* dices with (*s* + 1) numbered faces. If they are thrown randomly, what would be the chance of the sum of exhibited numbers to be equal to *k* ?", see also Hall and Knight [16]. Some years later, Euler [8, 9], studied these coefficients and derived a number of properties, as formulae (4), (6) below. In 1876, André [1] used combinations on words to establish several other properties.

Recently, the authors [3], published a paper that focused on a historical introduction of bi^snomial coefficient, as well as a presentation of some new arithmetical properties of these numbers. First, we need to introduce some definitions and concepts concerning bi^snomial coefficients, *s*-Pascal triangle and Catalan numbers.

1.1 Bi^snomial Coefficients

Definition 1.1 Let $s \geq 1$, $n \geq 0$ be integers and let $k \in \{0, 1, \dots, sn\}$. The bi^snomial coefficient denoted by $\binom{n}{k}_s$, is the coefficient of x^k in the following development

$$(1 + x + x^2 + \dots + x^s)^n = \sum_{k \geq 0} \binom{n}{k}_s x^k. \quad (1)$$

For $k < 0$ or $k > sn$, we have, $\binom{n}{k}_s = 0$. For $s = 1$, we get the classical binomial coefficient $\binom{n}{k}_1 = \binom{n}{k}$. In the literature of bi^snomial coefficients, we often meet the following well known properties

- Expression of bi^snomial coefficients in terms of binomial coefficients,

$$\binom{n}{k}_s = \sum_{j_1 + j_2 + \dots + j_s = k} \binom{n}{j_1} \binom{j_1}{j_2} \dots \binom{j_{s-1}}{j_s}. \quad (2)$$

- de Moivre alternate summation,

$$\binom{n}{k}_s = \sum_{j=0}^{\lfloor k/(s+1) \rfloor} (-1)^j \binom{n}{j} \binom{k - j(s+1) + n - 1}{n-1}. \quad (3)$$

- Symmetry relation,

$$\binom{n}{k}_s = \binom{n}{sn-k}_s. \quad (4)$$

- Generalized Pascal Formula,

$$\binom{n}{k}_s = \sum_{m=0}^s \binom{n-1}{k-m}_s. \quad (5)$$

- Diagonal recurrence relation,

$$\binom{n}{k}_s = \sum_{m=0}^n \binom{n}{m} \binom{m}{k-m}_{s-1}. \quad (6)$$

By definition, Pascal triangle is the triangular array of binomial coefficients, where each of their elements is calculated by using Pascal Formula, $\binom{n}{k} = \binom{n-1}{k} + \binom{n-1}{k-1}$. We consider a generalization of Pascal triangle denoted by s -Pascal triangle, as the array of bi^s nomial coefficients that are generated by using Relation (5). For example, Table 1, gives the 3-Pascal triangle in the left justified form. We find the first values of bi^s nomial coefficients in SLOANE [22], through using the codes A027907, A008287 and A053343, for, $s = 2$, $s = 3$ and $s = 4$, respectively.

Table 1: Triangle of bi^3 nomial coefficients $\binom{n}{k}_3$.

$n \backslash k$	0	1	2	3	4	5	6	7	8	9	10	11	12
0	1												
1	1	1	1	1									
2	1	2	3	4	3	2	1	0					
3	1	3	6	10	12	12	10	6	3	1			
4	1	4	10	20	31	40	44	40	31	20	10	4	1

1.2 Catalan Numbers

For a well introduction to Catalan numbers, their properties and combinatorial interpretations, the reader can refer to Stanley [23], Kochy [19]. Catalan numbers, named after the Belgian mathematician Eugène Charles Catalan (1814-1894), are defined as follows,

$$C_n = \frac{1}{n+1} \binom{2n}{n}, n \in \mathbb{Z}^+. \quad (7)$$

The generating function of these numbers is,

$$C(x) = \sum_n C_n x^n = \frac{1 - \sqrt{1 - 4x}}{2x}. \quad (8)$$

Catalan numbers are given in Sloane [22], by using the code A000108, the first elements are,

$$1, 1, 2, 5, 14, 42, 132, 429, 1430, 4862, 16796, 58786, 208012, \dots$$

These numbers could be generated by subtracting the mentioned columns of Pascal triangle, as given in Table 2. This permit us to get the three Formulae, (9), (10), (11).

$$C_n = \binom{2n}{n} - \binom{2n}{n+1}, n \geq 0. \quad (9)$$

$$C_n = \binom{2n-1}{n} - \binom{2n-1}{n+1}, n \geq 1. \quad (10)$$

$$C_{n+1} = \binom{2n}{n} - \binom{2n}{n+2}, n \geq 0. \quad (11)$$

In the following section, we give combinatorial interpretations of both bi^s nomial coefficients and generalized Pascal Formula, through using oriented paths that moving on Hypergrids.

Table 2: Right part of Pascal triangle.

1							
2	1						
	3	1					
6		4	1				
	10		5		1		
20		15		6		1	
	35		21		7		1
70		56		28		8	
							1
⋮	⋮	⋮	⋮	⋮			
$\binom{2n}{n}$	$\binom{2n-1}{n}$	$\binom{2n}{n+1}$	$\binom{2n-1}{n+1}$	$\binom{2n}{n+2}$			

2 Combinatorial interpretation of bi^s nomial coefficients

Freund [10], gave a combinatorial interpretation of bi^s nomial coefficients $\binom{n}{k}_s$, as the number of different ways of distributing k objects among n cells, where each cell contains at most s objects, see also, Bondarenko [4]. Recently, A. Bazeniar et al., [2], provided an interpretation of these numbers, as the number of lattice paths that connect the two points of a grid, $(0, 0)$ and $(k, n - 1)$, for $0 \leq k \leq sn$, by taking at most s vertices in the eastern direction. We begin by giving some definitions and terminologies that we need in the rest of this paper.

2.1 Definitions and Notations

We denote by $H_{n,s}$, an hypergrid of dimension n , (we consider n ordered directions), such that each axis contains s vertices without counting the vertex of origin O . As particular cases, for $s = 1$ and $n \geq 4$, hypergrids are called *hypercubes*, whereas, for $n = 2$ and $s \geq 2$, we talk about *grids*.

Definition 2.1 Let $n, s, p \in \mathbb{Z}^+$, $i \in \{1, 2, \dots, n\}$. An *up-oriented path* lying on the hypergrid $H_{n,s}$, is a path of a finite length, such that

1. it starts from the vertex O ,
2. when the path reaches the vertex U by taking the i^{th} direction, it should reach a vertex V by taking the $(i+p)^{\text{th}}$ direction.

We denote by p_{i_1, i_2, \dots, i_n} , an *up-oriented path* lying on the hypergrid $H_{n,s}$, that reached,

- i_1 vertices by taking the 1^{st} direction,
- i_2 vertices by taking the 2^{nd} direction,
- ⋮
- i_n vertices by taking the n^{th} direction,

with $0 \leq i_m \leq s$, for $m \in \{1, 2, \dots, n\}$.

We represent the *up-oriented path* p_{i_1, i_2, \dots, i_n} by the linear form,

$$\underbrace{11 \cdots 1}_{i_1 \text{ times}} \underbrace{22 \cdots 2}_{i_2 \text{ times}} \cdots \underbrace{nn \cdots n}_{i_n \text{ times}},$$

or by the power form, $1^{i_1} 2^{i_2} \cdots n^{i_n}$. We denote by the number k , the length of p_{i_1, i_2, \dots, i_n} , such that $k = i_1 + i_2 + \cdots + i_n$, as well as $P_{n,k,s}$ the set of all p_{i_1, i_2, \dots, i_n} of length k that lie on the hypergrid $H_{n,s}$.

Example 2.1 In Figure 1, we differentiate an *up-oriented path* from ordinary paths that lie on the grid $H_{2,3}$, as follows,

- The first path on the left is an *up-oriented path* because the directions are taken in an increasing order, then, we have, $p_{3,1} = 1112 = 1^3 2^1$.

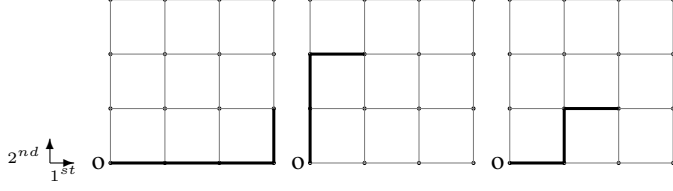

Figure 1: An up-oriented path and ordinary paths on the grid $H_{2,3}$.

- The second and the third paths to the right, are not up-oriented paths due to a disorder on directions of the two paths.

The following theorem gives a combinatorial interpretation of bi^snomial coefficients by counting the cardinality of the set $P_{n,k,s}$.

Theorem 2.1 For $n, k, s \in \mathbb{Z}_+$, with $0 \leq k \leq sn$, we have, $\#P_{n,k,s} = \binom{n}{k}_s$.

Proof 2.1 For $n = 0, 1, 2$, it is easy to verify the statement. We Suppose it true for n , let us prove it for the dimension $(n + 1)$. By using Relation (5), we get,

$$\begin{aligned}
\binom{n+1}{k}_s &= \sum_{m=0}^s \binom{n}{k-m}_s \\
&= \binom{n}{k}_s + \binom{n}{k-1}_s + \binom{n}{k-2}_s + \cdots + \binom{n}{k-s}_s \\
&= \sum_{i_{n+1}=0}^s \# \left\{ 1^{i_1} 2^{i_2} \cdots n^{i_n} \mid \sum_{m=1}^n i_m = k - i_{n+1}; i_1, i_2, \dots, i_n \leq s \right\} \\
&= \sum_{i_{n+1}=0}^s \# \left\{ 1^{i_1} 2^{i_2} \cdots n^{i_n} (n+1)^{i_{n+1}} \mid \sum_{m=1}^n i_m = k - i_{n+1}; i_1, i_2, \dots, i_n \leq s \right\} \\
&= \# \left\{ 1^{i_1} 2^{i_2} \cdots n^{i_n} (n+1)^{i_{n+1}} \mid \sum_{m=1}^{n+1} i_m = k; i_1, i_2, \dots, i_n, i_{n+1} \leq s \right\} \\
&= \#P_{n+1,k,s}.
\end{aligned}$$

Example 2.2 In Figure 2, we count four possible up-oriented paths of length 3 in the hypercube $H_{4,1}$. In Table 3, we distinguish these paths accordingly to their linear and power forms.

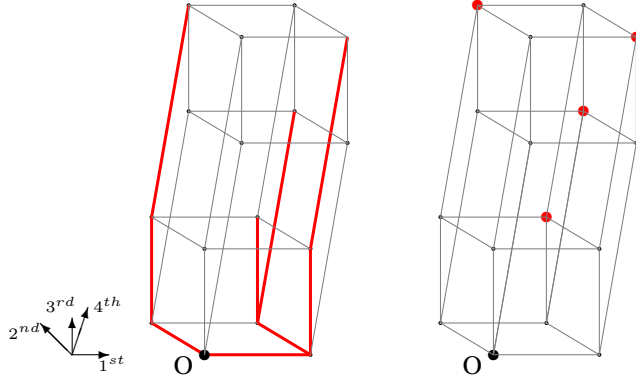

Figure 2: The up-oriented paths of length 3 in the hypergrid $H_{4,1}$ and their final vertices.

Table 3: Linear and power forms of the up-oriented paths of length 3 in the hypergrid $H_{4,1}$.

i_1	i_2	i_3	i_4	Linear forms	Power forms
1	1	1	0	123	$1^1 2^1 3^1 4^0$
1	1	0	1	124	$1^1 2^1 3^0 4^1$
1	0	1	1	134	$1^1 2^0 3^1 4^1$
0	1	1	1	234	$1^0 2^1 3^1 4^1$

In fact, $\# \left\{ 1^{i_1} 2^{i_2} 3^{i_3} 4^{i_4}; i_1 + i_2 + i_3 + i_4 = 3; i_1, i_2, i_3, i_4 \leq 1 \right\} = \binom{4}{3}_1 = \binom{4}{3} = 4$.

In the following subsection, by using Theorem 2.1, we derive a combinatorial interpretation of generalized Pascal Formula over hypergrids.

2.2 Combinatorial interpretation of generalized Pascal Formula

Definition 2.2 We denote by J_{n-1} , the projection map on the hypergrid $H_{n-1,s}$, defined as,

$$J_{n-1} : \begin{array}{l} P_{n,k,s} \rightarrow \bigcup_{m=0}^s P_{n-1,k-m,s} \\ p_{i_1, i_2, \dots, i_n} \mapsto p_{i_1, i_2, \dots, i_{n-1}} \end{array}$$

Theorem 2.2 The generalized Pascal Formula, $\binom{n}{k}_s = \sum_{m=0}^s \binom{n-1}{k-m}_s$, can be interpreted over hypergrids by the following bijection, $P_{n,k,s} \stackrel{J_{n-1}}{\sim} \bigcup_{m=0}^s P_{n-1,k-m,s}$.

Proof 2.2 Obviously, the map J_{n-1} is surjective by definition, so, $J_{n-1}(P_{n,k,s}) = \bigcup_{m=0}^s P_{n-1,k-m,s}$. On one hand, by Theorem 2.1, we have, $\#P_{n,k,s} = \binom{n}{k}_s$. On the other hand, for all $m_1, m_2 \in \{0, 1, \dots, s\}$, such that $m_1 \neq m_2$, it is clear that, $P_{n-1,k-m_1,s} \cap P_{n-1,k-m_2,s} = \emptyset$, so, $\#J_{n-1}(P_{n,k,s}) = \#\bigcup_{m=0}^s P_{n-1,k-m,s} = \sum_{m=0}^s \#P_{n-1,k-m,s} = \sum_{m=0}^s \binom{n-1}{k-m}_s = \binom{n}{k}_s$. Consequently, we have proved that the two sets $P_{n,k,s}$ and $\bigcup_{m=0}^s P_{n-1,k-m,s}$, have the same cardinality, then, they are in bijection.

Example 2.3 For $n = 4, k = 6, s = 3$, the generalized Pascal Formula, $\binom{4}{6}_3 = \sum_{m=0}^3 \binom{3}{6-m}_3 = 10 + 12 + 12 + 10$, is interpreted over hypergrids by the following bijection, $P_{4,6,3} \stackrel{J_3}{\sim} P_{3,6,3} \cup P_{3,5,3} \cup P_{3,4,3} \cup P_{3,3,3}$, see Table 4,

Table 4: The bijection $P_{4,6,3} \stackrel{J_3}{\sim} \bigcup_{m=0}^3 P_{3,6-m,3}$.

$P_{4,6,3}$	$P_{3,6,3}$	$P_{4,6,3}$	$P_{3,5,3}$	$P_{4,6,3}$	$P_{3,4,3}$	$P_{4,6,3}$	$P_{3,3,3}$
111222	111222	111234	11123	111244	1112	111444	111
111223	111223	222334	22233	123344	1233	222444	222
112223	112223	111334	11133	112344	1123	333444	333
111233	111233	112234	11223	223344	2233	233444	233
111333	111333	112334	11233	122344	1223	133444	133
222333	222333	122234	12223	112244	1122	123444	123
122233	122233	113334	11333	113344	1133	223444	223
122333	122333	112224	11222	233344	2333	122444	122
112333	112333	123334	12333	122244	1222	112444	112
112233	112233	223334	22333	133344	1333	113444	113
		122334	12233	222344	2223		
		111224	11122	111344	1113		

3 Generalized Catalan numbers

In this section, our aim is to generalize Catalan numbers by using s -Pascal triangle, as well as to extend their identities corresponding to this generalization. First, we recall some generalizations of Catalan numbers.

Stanley, [23], Koshy, [19] and Grimaldi, [15], collect many combinatorial interpretations of Catalan numbers through using: paths, parenthesis, words or binary numbers, binary trees, . . . In 1791, before Eugène Charles Catalan studied these numbers, Fuss, [11], introduced Fuss-numbers, given under many expressions, as, $F(k, n) = \frac{1}{(k-1)n+1} \binom{kn}{n}$, see [14], or, $F(k, n) = \frac{1}{kn+1} \binom{kn+1}{n}$, see [19], also as follows, $F(k, n) = \frac{1}{n} \binom{kn}{n-1}$, see, [15, 17]. We mention that, for $k = 2$, $F(2, n)$ gives the Catalan numbers. A combinatorial interpretation of these numbers is given as the number of paths from $(0, 0)$ to $(n, (k-1)n)$, which take steps of the set $\{(0, 1), (1, 0)\}$, that lie below the line $y = (k-1)x$, see [20].

Raney numbers, [21], are defined as $R(k, r, n) = \frac{r}{kn+r} \binom{kn+r}{n}$, this is a generalization of Fuss-numbers, as we have, $R(k, 1, n) = F(k, n)$. $R(k, r, n)$ counts the forests composed by r ordered rooted trees, with k components and n vertices, see [23].

Hilton and Pedersen, [17], presented a solution to the well known ballot problem, as well as they gave a generalization of Catalan numbers. They showed that the number of paths lie completely below the line $y = x$, which connect the two points $(1, 0)$ and (a, b) , for $a > b$ two integers, is equal to the number $\frac{a-b}{a+b} \binom{a+b}{a}$. As a particular case, for $a = n + 1$ and $b = n$, we get the Catalan numbers.

Gessel,[12], called $S(m, n) = \frac{(2m)!(2n)!}{m!n!(m+n)!}$ as Super-Catalan numbers. This is a generalization of Catalan numbers, as we have, $S(1, n)/2 = C_n$. Gessel and Xin, [13], presented a combinatorial interpretation of these numbers for $m = 2, 3$, by using the famous Dyck paths.

Koç et al., [18], gave the following generalization, $C(n, m) = \frac{n-m+1}{n+1} \binom{n+m}{n}$, with $m \leq n$. As a particular case, $C(n, n)$ gives Catalan numbers. They showed that $C(n, m)$ is the number of paths from $(0, 0)$ to (n, m) through using right step and up-step without moving upper the line $x = y$.

3.1 s -Catalan numbers

In the rest of this paper we consider an odd integer s . First, we define central bi^snomial coefficients as a generalization of central binomial coefficients, as follows

Definition 3.1 For $n \in \mathbb{Z}^+$, central bi^snomial coefficients are given by the following form, $\binom{2n}{sn}_s$.

Remark 3.1 Central bi^snomial coefficients divide s -Pascal triangle into two symmetric parts, as in the classical case, for $s = 1$.

Definition 3.2 For $n \geq 0$, we define s -Catalan numbers as

$$C_{n,s} = \binom{2n}{sn}_s - \binom{2n}{sn+1}_s. \quad (12)$$

The values which correspond to the s -Catalan numbers appeared in physics of particles theory (under another appellation), especially, in the issues related to *spin* multiplicities, see the two recent papers of, E. Cohen et al., [5] and T. Curtright et al., [6].

We get the s -Catalan numbers by subtracting from the middle column of the s -Pascal triangle, $\binom{2n}{sn}_s$, its next column to the right of the same level, $\binom{2n}{sn+1}_s$. For $s = 3$, Table 5 and Table 6, give the first numbers of 3-Catalan numbers as follows,

1, 1, 4, 34, 364, 4269, 52844, 679172, 8976188, 121223668, 1665558544, ...,
see [22], as A264607.

Table 5: The first columns of 3-Pascal triangle right part.

1									
4	1		1						
44	12	3	10	2		1		3	1
580	155	40	135	31	6	20	65	10	35
8092	2128	546	1918	456	1554	5328	1128	3823	720
⋮	⋮	⋮	⋮	⋮	⋮	⋮	⋮	⋮	⋮
$\binom{2n}{3n}_3$	$\binom{2n-1}{3n-1}_3$	$\binom{2n}{3n+1}_3$	$\binom{2n-1}{3n}_3$	$\binom{2n}{3n+2}_3$	$\binom{2n-1}{3n+1}_3$	$\binom{2n}{3n+3}_3$	$\binom{2n-1}{3n+1}_3$	$\binom{2n}{3n+3}_3$	⋯

Through using 5-Pascal triangle, the first values of 5-Catalan numbers, are

1, 1, 6, 111, 2666, 70146, 1949156, 56267133, 1670963202, 50720602314, ...,
see [22], as A272391.

The following theorem gives the generalization of Formulae (10) and (11), respectively.

Table 6: Generating of 3-Catalan numbers by definition.

n	$\binom{2n}{3n}_3$	$\binom{2n}{3n+1}_3$	$C_{n,3} = \binom{2n}{3n}_3 - \binom{2n}{3n+1}_3$
0	1	0	1
1	4	3	1
2	44	40	4
3	580	546	34
4	8092	7728	364
5	116304	112035	4269
6	1703636	1650792	52844
7	25288120	24608948	679172
8	379061020	370084832	8976188
9	5724954544	5603730876	121223668
10	86981744944	85316186400	1665558544

Theorem 3.1 We have,

$$C_{n,s} = \binom{2n-1}{sn}_s - \binom{2n-1}{sn+1}_s, \quad n \geq 1. \quad (13)$$

$$C_{n+1,s} = \binom{2n}{sn}_s - \binom{2n}{sn+(s+1)}_s, \quad n \geq 0. \quad (14)$$

Proof 3.1 By using Formula (5), we get, $C_{n,s} = \binom{2n}{sn}_s - \binom{2n}{sn+1}_s = \sum_{m=0}^s \binom{2n-1}{sn-m}_s - \sum_{m=0}^s \binom{2n-1}{sn+1-m}_s = \binom{2n-1}{sn-s}_s - \binom{2n-1}{sn+1}_s$. Formula (4) gives, $\binom{2n-1}{sn-s}_s = \binom{2n-1}{sn}_s$, then we find, $C_{n,s} = \binom{2n-1}{sn}_s - \binom{2n-1}{sn+1}_s$.

To get Formula (14), first we calculate $C_{n+1,s}$, by using Formula (12), then we follow the same proof of Formula (13), by applying Formula (5) twice.

As a future work, we want to find a combinatorial interpretation of s -Catalan numbers, especially, by using up -oriented paths on hypergrids.

References

- [1] D. André. Mémoire sur les combinaisons régulière et leurs applications, *Annales scientifique de l'ENS*. 2^{eme} série, tome 5, pages 155–198, 1876.
- [2] A. Bazeniar, M. Ahmia, H. Belbachir. Connection between bi^s nomial coefficients and their analogs and symmetric functions. *Turkish Journal of Mathematics*, 42, pages 807–818, doi: 10.3906/mat-1705-27, 2018.
- [3] H. Belbachir, O. Igueroufa. Congruence properties for bi^s nomial coefficients and like extended Ram and Kummer theorems under suitable hypothesis. *Mediterranean Journal of Mathematics*, 17:36, <https://doi.org/10.1007/s00009-019-1457-0>, 2020.
- [4] B. Bondarenko. Generalized Pascal triangle and Pyramids, their fractals graphs and applications. *The Fibonacci Association, Santa Clara*, 1993.
- [5] E. Cohen, T. Hansen, N. Itzhanki. From entanglement witness to generalized Catalan numbers. *Scientific Reports*, 6:30232, doi:10.1038/srep30232, 2016.
- [6] T. Curtright, T. V. Korczyk, C. Zachos. Spin Multiplicities. *Physics letter A. Elsevier*, 381, pages 422–427, 2017.
- [7] A. de Moivre. The Doctrine of Chances, 3rd ed. *London: Millar*, 1756, rpt. *New York: Chelsea*, 1967.
- [8] L. Euler. De evolutione potestatis polynomialis cuiuscunque $(1+x+x^2+\dots)^n$. *Nova Acta Academiae Scientarum Imperialis Petropolitinae* 12, 1801, 47-57; *Opera Omnia*: Series 1, Volume 16, 28–40. Original copy is available online in Euler's archive.
- [9] L. Euler. Observationes analyticae, Novi Commentarii Academiae Scientarum Petropolitanae. 11, 1767, 124–143, *Opera Omnia*, Series 1 Vol. 15, 50–69. Original copy is available online in Euler's archive.
- [10] J. E. Freund. Restricted Occupancy Theory A Generalization of Pascal's Triangle. *The American Mathematical Monthly*, 63, No. 1, pages 20–27, 1956.

- [11] N. Fuss. Solutio quaestionis, quot modis polygonum n laterum in polygona m laterum, per diagonales resolvi quaeat. *Nova acta academiae scientiarum imperialis Petropolitanae*, 9, p. 243–251, 1791.
- [12] I. M. Gessel. Super ballot numbers. *Journal of Symbolic Computation. Elsevier*, 14, pages 179–194, 1992.
- [13] I. M. Gessel, G. Xin. A combinatorial interpretation of the numbers $6(2n)!n!(n+2)!$. *Journal of Integer Sequences*, 8, article 05.2.3, 2005.
- [14] R. L. Graham, D. E. Knuth, O. Patashnik. Concrete Mathematics. *Addison-Wesley*, Boston, 1994.
- [15] R. P. Grimaldi. Fibonacci and Catalan numbers An introduction. *Wiley*, 2012.
- [16] H. S. Hall, S. R. Knight. Higher Algebra: a Sequel to Elementary Algebra for Schools. *London : Macmillan and Co*, 1894.
- [17] P. Hilton, J. Pedersen. Catalan numbers, their generalization, and their uses. *The Mathematical Intelligencer*, 13, pages 64–75, 1991.
- [18] C. Koç, I. Güloğlu, S. Esin. Generalized Catalan number, sequences and polynomials. *Turkish Journal of Mathematics*, 34, pages 441–449, 2010.
- [19] T. Koshy. Catalan Numbers with Applications. *Oxford University Press*, 2009.
- [20] C.H. Lin. Some Combinatorial Interpretations and Applications of Fuss-Catalan Numbers. *International Scholarly Research Network ISRN Discrete Mathematics*, article ID 534628, doi:10.5402/2011/534628, 2011.
- [21] G. N. Raney. Functional composition patterns and power series reversion. *American Mathematical Society*, 94, No 3, pages 441–451, 1960.
- [22] Sloane. The On-Line Encyclopedia of Integer Sequences. Available on line at <https://oeis.org/>.
- [23] R. P. Stanley. Catalan numbers. *Cambridge University Press*, 2015.

GRAPHS CONTAINING FINITE INDUCED PATHS OF UNBOUNDED LENGTH

Maurice Pouzet

Univ. Lyon, Université Claude-Bernard Lyon1
CNRS UMR 5208, Institut Camille Jordan
43, Bd. du 11 Novembre 1918, 69622
Villeurbanne, France

et

Department of Mathematics and Statistics
University of Calgary, Calgary, Alberta, Canada
pouzet@univ-lyon1.fr

Imed Zaguia*

*Department of Mathematics & Computer Science
Royal Military College of Canada
P.O.Box 17000, Station Forces
Kingston, Ontario, Canada K7K 7B4 zaguia@rmc.ca

ABSTRACT

The age $\mathcal{A}(G)$ of a graph G (undirected and without loops) is the collection of finite induced subgraphs of G , considered up to isomorphism and ordered by embeddability. It is well-quasi-ordered (wqo) for this order if it contains no infinite antichain. A graph is *path-minimal* if it contains finite induced paths of unbounded length and every induced subgraph G' with the same property admits an embedding of G . We construct 2^{\aleph_0} path-minimal graphs whose ages are pairwise incomparable with set inclusion and which are wqo. Our construction is based on uniformly recurrent sequences and lexicographical sums of labeled graphs.

Keywords (partially) ordered set · incomparability graph · graphical distance · isometric subgraph · paths · well quasi order · symbolic dynamic · sturmian words · uniformly recurrent sequences

1 Introduction and presentation of the results

We consider graphs that are undirected, simple and have no loops. Let $H = (X, F)$ be a graph and let $(G_x = (V_x, E_x))_{x \in X}$ be a family of graphs whose vertex sets are pairwise disjoint. The *lexicographical sum* of $(G_x)_{x \in X}$ (over the graph H) is the graph $H[G_x, x \in X]$ whose vertex set is $\cup_{x \in X} V_x$ and two vertices u_x and $v_{x'}$ are adjacent if $x = x'$ and $\{u_x, v_x\} \in E_x$ or $x \neq x'$ and $\{x, x'\} \in F$. If H is empty i.e. $F = \emptyset$, the lexicographical sum is called a *direct sum*. Else if H is a complete graph, then the lexicographical sum is called the *complete sum*.

Among those graphs with finite induced paths of unbounded length, we ask which one are unavoidable. If a graph is an infinite path, it can be avoided: it contains a direct sum of finite paths of unbounded length. This latter one, on the other hand, cannot be avoided. Indeed, two direct sums of finite paths of unbounded length embed in each other. Similarly, two complete sums of finite paths of unbounded length embed in each other. Hence, the direct sum, respectively the complete sum of finite paths of unbounded length are, in our sense, unavoidable. Are there other examples? This question is the motivation behind this article.

We recall that the *age* of a graph G is the collection $\text{Age}(G)$ of finite induced subgraphs of G , considered up to isomorphism and ordered by embeddability (cf. [7]). It is *well-quasi-ordered* (wqo) for this order if it contains no infinite antichain. A *path* is a graph P such that there exists a one-to-one map f from the set $V(P)$ of its vertices into an interval I of the chain \mathbb{Z} of integers in such a way that $\{u, v\}$ belongs to $E(P)$, the set of edges of P , if and only if $|f(u) - f(v)| = 1$ for every $u, v \in V(P)$. If $I = \{1, \dots, n\}$, then we denote that path by P_n ; its *length* is $n - 1$, so, if $n = 2$, P_2 is made of a single edge, whereas if $n = 1$, P_1 is a single vertex. We denote by P_∞ the path on \mathbb{N} . The *detour* of a graph G [4] is the supremum of the length of induced paths included in G . Our aim is to give a structural

*Corresponding author. Supported by Canadian Defence Academy Research Program (CDARP) and NSERC DDG-2018-00011.

result on graphs with infinite detour (for the existence of infinite paths we refer to [14, 19, 27]). We say that a graph G is *path-minimal* if its detour is infinite and every induced subgraph G' with infinite detour embeds admits an embedding of G . Let $\oplus_n P_n$ respectively $\sum_n P_n$ be the direct sum, respectively the complete sum of paths P_n . These graphs are path-minimal graphs. There are others. Our main result is this.

Theorem 1 *There are 2^{\aleph_0} path-minimal graphs whose ages are pairwise incomparable and wqo.*

Our construction uses uniformly recurrent sequences, and in fact Sturmian sequences (or billiard sequences) [17, 6], and lexicographical sums of labelled graphs. The existence of 2^{\aleph_0} wqo ages is a non trivial fact. It was obtained for binary relations in [21] and for undirected graphs in [24] and in [25]. The proofs were based on uniformly recurrent sequences. These sequences were also used in [15].

We leave open the following:

Problems 1 [(i)]

If a graph admits an embedding of finite induced path of unbounded length, does it embed a path-minimal graph?

2. *If a graph is path-minimal, is its age wqo?*
3. *If a graph G is path-minimal, can G be equipped with an equivalence relation \equiv whose blocks are paths in such a way that (G, \equiv) is path-minimal?*

In some situations there are only two path-minimal graphs (up to equimorphy).

Theorem 2 *If the incomparability graph of a poset admits an embedding of finite induced paths of unbounded length, then it admits an embedding of the direct sum or the complete sum of finite induced paths of unbounded length.*

If $G := (V, E)$ is a graph, and x, y are two vertices of G , we denote by $d_G(x, y)$ the length of the shortest path joining x and y if any, and $d_G(x, y) := +\infty$ otherwise. This defines a distance on V with values in the completion $\overline{\mathbb{N}^+} := \mathbb{N}^+ \cup \{+\infty\}$ of non-negative integers. This distance is the *graphic distance*. If A is a subset of V , the graph G' induced by G on A is an *isometric subgraph* of G if $d_{G'}(x, y) = d_G(x, y)$ for all $x, y \in A$.

If instead of induced path we consider isometric paths, then

Theorem 3 *If a graph admits an embedding of isometric finite paths of unbounded length, then it admits an embedding of a direct sum of such paths.*

We examine the primality of the graphs we obtain. Prime (or indecomposable) graphs are the building blocks of the construction of graphs ([2, 8, 9, 11, 12, 23, 26]). Direct and complete sums of finite paths of unbounded length are not prime and not equimorphic to prime graphs. We construct 2^{\aleph_0} examples, none of them being equimorphic to a prime one. We construct also 2^{\aleph_0} which are prime. These examples are minimal in the sense of [22], but not in the sense of [23] nor in the sense of [18] p. 92.

We conclude this introduction with:

1.0.1 An outline of the proof of Theorem 1.

It uses two main ingredients. One is the so called uniformly recurrent sequences (or words).

A *uniformly recurrent* word with domain \mathbb{N} is a sequence $u := (u(n))_{n \in \mathbb{N}}$ of letters such that for any given integer n there is some integer $m(u, n)$ such that every factor v of u of length at most n appears as a factor of every factor of u of length at least $m(u, n)$. [1, 3, 16, 6]. To a uniformly recurrent word u on the alphabet $\{0, 1\}$ we associate P_u , the path on \mathbb{N} with a loop at every vertex n for which $u(n) = 1$ and no loop at vertices for which $u(n) = 0$. Next comes the second ingredient.

Fix a binary operation \star on $\{0, 1\}$. Define the lexicographical sum of copies of P_u over the chain ω , denoted by $P_u \cdot_\star \omega$, and made of pairs $(i, v) \in \omega \times P_u$, with an edge between two vertices (i, n) and (j, m) of $P_u \cdot_\star \omega$, such that $i < j$, if $u(n) \star u(m) = 1$. Since u is uniformly recurrent, the set $Fac(u)$ of finite factors of u is wqo w.r.t the factor ordering, hence by a theorem of Higman [10] (see also [20]), the ages of P_u and of $G_{(u, \star)} := P_u \cdot_\star \omega$ are wqo. Deleting the loops, we get a graph that we denote $\widehat{G}_{(u, \star)}$ and whose age is also wqo. Let $\widehat{Q}_{(u, \star)}$ be the restriction of $\widehat{G}_{(u, \star)}$ to the set $\{(m, n) : n < m + 4\}$ of $V := \mathbb{N} \times \mathbb{N}$. This restriction has the same age as $\widehat{G}_{(u, \star)}$ and it is path-minimal. If the

operation \star is constant and equal to 0, respectively equal to 1, $\widehat{Q}_{(u,\star)}$ is a direct sum, respectively a complete sum of paths. To conclude the proof of the theorem, we need to prove that there is some operation \star and 2^{\aleph_0} words u such that the ages of $\widehat{G}_{(u,\star)}$ are incomparable. This is the substantial part of the proof. For that, we prove that if \star is the Boolean sum or a projection and u is uniformly recurrent then every long enough path in $\widehat{G}_{(u,\star)}$ is contained in some projection (subset of the form $\{i\} \times \mathbb{N}$). This is a rather technical fact. We think that it holds for any operation. We deduce that if $Fac(u)$ and $Fac(u')$ are not equal up to reversal or to addition (mod 2) of the constant word 1 the ages of $\widehat{G}_{(u,\star)}$ and $\widehat{G}_{(u',\star)}$ are incomparable w.r.t. set inclusion. To complete the proof of Theorem 1, we then use the fact that there are 2^{\aleph_0} uniformly recurrent words u_α on the two-letter alphabet $\{0, 1\}$ such that for $\alpha \neq \beta$ the collections $Fac(u_\alpha)$ and $Fac(u_\beta)$ of their finite factors are distinct, and in fact incomparable with respect to set inclusion (this is a well-known fact of symbolic dynamic, e.g. Sturmian words with different slopes will do [6], Chapter 6 page 143).

The proofs will appear in the full version of the paper.

References

- [1] J-P. Allouche and J. Shallit, *Automatic Sequences: Theory, Applications, Generalizations*. Cambridge University Press, 2003; ISBN: 0-521-82332-3
- [2] R. Assous, M. Pouzet, *Jónsson posets*, Algebra Universalis, 79 (2018) no. 3, Art. 74, 26 pp.
- [3] V. Berthé and M. Rigo eds. *Combinatorics, automata, and number theory*. Encyclopedia of Mathematics and its Applications. 135. 2010, Cambridge: Cambridge University Press. ISBN 978-0-521-51597-9.
- [4] F. Buckley and F. Harary, *On longest induced paths in graphs*. Chinese Quart. J. Math., **3** (3), (1968) 61–65.
- [5] A. Ehrenfeucht, T. Harju, G. Rozenberg, *The theory of 2-structures. A framework for decomposition and transformation of graphs*. World Scientific Publishing Co., Inc., River Edge, NJ, 1999.
- [6] N. Pytheas Fogg, *Substitutions in dynamics, arithmetics and combinatorics*, Valérie Berthé, Sébastien Ferenczi, Christian Mauduit and Anne Siegel, eds., Lecture Notes in Mathematics. 1794. Berlin: Springer-Verlag, 2002.
- [7] R. Fraïssé, *Theory of relations*. Revised edition. With an appendix by Norbert Sauer. Studies in Logic and the Foundations of Mathematics, 145. North-Holland Publishing Co., Amsterdam, 2000. ii+451.
- [8] R. Fraïssé, *L'intervalle en théorie des relations, ses généralisations, filtre intervallaires et clôture d'une relation*, In "Orders, description and roles", M. Pouzet and D. Richard(éd), Annals of Discrete Math., **23** (1984), 343–358.
- [9] T. Gallai, *Transitiv orientierbare Graphen*, Acta Math. Acad. Sci. Hungar., **18** (1967), 25–66 (English translation by F. Maffray and M. Preissmann in J.J. Ramirez-Alfonsin and B. Reed (Eds), Perfect graphs, Wiley 2001, pp. 25–66).
- [10] G. Higman, *Ordering by divisibility in abstract algebras*. Proc. London Math. Soc. **3** (1952), 326–336.
- [11] P. Ille, *A characterization of the indecomposable and infinite graphs*, Glob. J. Pure Appl. Math., **3**, (2005) 272–285.
- [12] D. Kelly, *Comparability graphs*, NATO Adv. Sci. Inst. Ser. C Math. Phys. Sci., **147** (1985), 3–40.
- [13] K. Kearnes, G. Oman, *Jónsson posets and unary Jónsson algebras*, Algebra Universalis **69** (2013), no. 2, 101–112.
- [14] D. Kőnig, *Über eine Schlussweise aus dem Endlichen ins Unendliche*, Acta Sci. Math. (Szeged) (in German) (3(2-3)): (1927), 121–130.
- [15] C. Laflamme, M. Pouzet, N. Sauer, I. Zaguia, *Orthogonal countable ordinals*, Discrete Math. **335**(2014) 35–44.
- [16] M. Lothaire, *Finite and Infinite Words*. In Algebraic Combinatorics on Words (Encyclopedia of Mathematics and its Applications, pp. 1–44). Cambridge: Cambridge University Press, 2002. doi:10.1017/CBO9781107326019.002
- [17] M. Morse and G. A. Hedlund, *Symbolic Dynamics II. Sturmian Trajectories*. American Journal of Mathematics. **62** (1940): 1–42.
- [18] D. Oudrar, *Sur l'énumération de structures discrètes: une approche par la théorie des relations*. Thèse de doctorat, Université d'Alger USTHB à Bab Ezzouar, 28 sept. 2015, ArXiv:1604.05839.
- [19] N. Polat, *Graphs Without Isometric Rays and Invariant Subgraph Properties, I*, Journal of Graph Theory, Volume 27, Issue 2, (1998), 99–109.
- [20] M. Pouzet, *Un belordre d'abritement et ses rapports avec les bornes d'une multirelation*. Comptes rendus Acad. Sci. Paris **274(A)** (1972), pp. 1677–1680.
- [21] M. Pouzet, *Sur la théorie des relations*, Thèse de doctorat d'État, Université Claude-Bernard, Lyon, 23 Janvier 1978.

- [22] M. Pouzet, *Relation minimale pour son âge*, Zeitsch. f. math. Logik und Grundlag d. Math. Bd. 25, S. 315-344 (1979).
- [23] M. Pouzet and I. Zaguia, *On Minimal Prime Graphs and Posets*, Order **16** (2009), 357–375.
- [24] M. Sobrani, *Structure d'ordre de la collection des âges de relations*, Thèse de doctorat, Université Claude-Bernard, Lyon, 18 déc. 1992.
- [25] M. Sobrani, *Sur les âges de relations et quelques aspects homologiques des constructions $D+M$* , Thèse de doctorat d'état, Université S.M.Ben Abdallah-Fez, Fez, January 2002.
- [26] D.P. Sumner, *Graphs indecomposable with respect to the X -join*, Discrete Math., **6** (1973), 281–298.
- [27] M.E. Watkins, *Infinite paths that contain only shortest paths*, Journal of Combinatorial Theory, Series B Volume 41, Issue 3, December 1986, 341–355.

MONOTONIC COMPUTATION RULES FOR NONASSOCIATIVE CALCULUS

Miguel Couceiro

Université de Lorraine, CNRS, Inria N.G.E., LORIA
F-54000 Nancy, France
miguel.couceiro@loria.fr

Michel Grabisch

Paris School of Economics, University of Paris I
106-112, Bd de l'Hôpital, 75013 Paris, France
michel.grabisch@univ-paris1.fr

Dedicated to Maurice Pouzet on the occasion of his 75th birthday

ABSTRACT

In this paper we revisit the so-called computation rules for calculus using a single nonassociative binary operation over possibly infinite sequences of integers. In this paper we focus on the symmetric maximum \otimes that is an extension of the usual maximum \vee so that 0 is the neutral element, and $-x$ is the symmetric (or inverse) of x , i.e., $x \otimes (-x) = 0$. However, such an extension does not preserve the associativity of \vee . This fact asks for systematic ways of bracketing terms of a sequence using \otimes , and which we refer to as *computation rules*.

These computation rules essentially reduce to deleting terms of sequences based on the condition $x \otimes (-x) = 0$, and they can be quasi-ordered as follows: say that rule 1 is below rule 2 if for all sequences of numbers, rule 1 deletes more terms in the sequence than rule 2. As it turns out, this quasi-ordered set is extremely complex, e.g., it has infinitely many maximal elements and atoms, and it embeds the powerset of natural numbers by inclusion.

Local properties of computation rules have also been presented by the authors, in particular, concerning their canonical representations. In this paper we address the problem of determining those computation rules that preserve the monotonicity of \vee , and present an explicit description of monotonic computation rules in terms of their *factorized irredundant form*.

Keywords Nonassociative calculus · symmetric maximum · computation rules · monotonic rules

1 Motivation

This short contribution is the continuation of the work initiated in [1, 2], and we refer the reader to these references for further motivation. Let L be a totally ordered set with bottom element 0, and let $-L := \{-a : a \in L\}$ be its “symmetric” copy endowed with the reversed order. Consider the symmetric ordered structure $\tilde{L} := L \cup (-L) \setminus \{-0\}$, a bipolar scale analogous to the real line where the zero acts as a neutral element and such that $a + (-a) = 0$ (symmetry). In particular, $-(-a) = a$.

The *symmetric maximum* \otimes is intended to extend the maximum on L with 0 as neutral element, while fulfilling symmetry. However, this symmetry requirement immediately entails that any extension \otimes of the maximum operator \vee cannot be associative. To illustrate this point, let $L = \mathbb{N}$ and observe that $(2 \otimes 3) \otimes (-3) = 3 \otimes (-3) = 0$ whereas $2 \otimes (3 \otimes (-3)) = 2 \otimes 0 = 2$.

Nonetheless, Grabisch [3] showed that the “best” definition of \otimes (see Theorem 1 below) is:

$$a \otimes b = \begin{cases} -(|a| \vee |b|) & \text{if } b \neq -a \text{ and } |a| \vee |b| = -a \text{ or } = -b \\ 0 & \text{if } b = -a \\ |a| \vee |b| & \text{otherwise.} \end{cases} \quad (1)$$

In other words, if $b \neq -a$, then $a \otimes b$ returns the element that is the larger in absolute value among the two elements a and b . Moreover, it is not difficult to see that \otimes satisfies the following properties:

- (C1) \otimes coincides with the maximum on L^2 ;
- (C2) $a \otimes (-a) = 0$ for every $a \in \tilde{L}$;
- (C3) $-(a \otimes b) = (-a) \otimes (-b)$ for every $a, b \in \tilde{L}$.

Hence, \otimes almost behaves like $+$ on the real line, except for associativity $a \otimes (b \otimes c) = (a \otimes b) \otimes c$, for every $a, b, c \in \tilde{L}$. For instance, we have: $(-3 \otimes 3) \otimes 1 = 0 \otimes 1 = 1$ but $-3 \otimes (3 \otimes 1) = -3 \otimes 3 = 0$. However, it was shown in [3] that if one requires that (C1), (C2) and (C3) hold, then (1) is the best possible definition for \otimes .

Theorem 1. [3, Prop. 5] No binary operation satisfying (C1), (C2), (C3) is associative on a larger domain than \otimes .

Further properties of \otimes were presented in [3, 1, Prop. 5]. In particular, it was shown that \otimes is associative on an expression involving $a_1, \dots, a_n \in \tilde{L}$, with $|\{i : a_i \neq 0\}| > 2$, if and only if $\bigvee_{i=1}^n a_i \neq -\bigwedge_{i=1}^n a_i$. Sequences fulfilling this condition were referred to as *associative* in [1].

To remove the ambiguity when evaluating \otimes on nonassociative sequences, Grabisch [3] suggested ways of making \otimes associative. The solution proposed was to define a *rule of computation*, that is, a systematic way of putting parentheses so that the result is no longer ambiguous. Let us present here informally three of these rules¹ that are rather natural:

- (i) aggregate separately positive and negative terms, then compute their symmetric maximum. Taking the sequence 3, 2, -3, 1, -3, -2, 1, we obtain

$$\begin{aligned} \otimes(3, 2, -3, 1, -3, -2, 1) &= (3 \otimes 2 \otimes 1 \otimes 1) \otimes ((-3) \otimes (-3) \otimes (-2)) \\ &= 3 \otimes (-3) = 0. \end{aligned}$$

- (ii) aggregate first extremal opposite terms to cancel them, till there is no more extremal opposite terms. This gives:

$$\begin{aligned} \otimes(3, 2, -3, 1, -3, -2, 1) &= (3 \otimes (-3)) \otimes (2 \otimes 1 \otimes (-3) \otimes (-2) \otimes 1) \\ &= 0 \otimes (-3) = -3. \end{aligned}$$

- (iii) the same as above, but first aggregate these extremal opposite terms. This gives:

$$\begin{aligned} \otimes(3, 2, -3, 1, -3, -2, 1) &= (3 \otimes ((-3) \otimes (-3))) \otimes (2 \otimes (-2)) \otimes (1 \otimes 1) \\ &= (3 \otimes (-3)) \otimes 0 \otimes 1 = 0 \otimes 1 = 1. \end{aligned}$$

One sees that all results differ, and that many other rules can be created. In fact, it is more convenient to define a rule as a systematic way of *deleting* terms in a sequence of numbers, so as to make it associative, provided the way of deleting terms corresponds to some arrangement of parentheses. Indeed, the first rule consists in deleting all terms whenever the sequence does not fulfill the condition of associativity. The second rule consists in deleting recursively all pairs of extremal opposite elements, and the third rule deletes recursively all occurrences of extremal opposite elements. However, one has to be careful that any systematic way of deleting elements making any sequence associative does not necessarily correspond to an arrangement of parentheses. For example, deleting the maximal element 3 in the above sequence makes it associative, however no arrangement of parentheses can produce this.

This framework based on rules of computation was formalized in [1], and we will recall it in the next section. We will also recall equivalent, yet semantically rather different, quasi-orderings of rules, and briefly survey the main characteristics of the resulting partially ordered set of (equivalent classes) of computation rules.

Denoting a computation rule by R , \otimes_R is an unambiguously defined operator acting on any sequence of \tilde{L} , by first making the sequence associative by means of R , and then computing the result by \otimes . Then, to any given computation rule R corresponds an *aggregation operator* \otimes_R , aggregating all "numbers" of a sequence into a single number in \tilde{L} . In the sequel, we only deal with countable sets L , so that \tilde{L} can be thought to be \mathbb{Z} . It follows that such a study is related to the aggregation of integers, in particular to the so-called integer means or \mathbb{Z} -means, see [4]. In the latter work, it is shown that the decomposability property introduced by Kolmogoroff [5] imposes a very limitative form of integer means, namely that the output depends only on the smallest and greatest entries. In [2], we have weakened the decomposability property and shown that a whole family of operators \otimes_R can serve as integer means.

The main objective of this paper is to study monotonic computation rules R , that is, leading to an aggregation operator \otimes_R which is monotonically nondecreasing w.r.t. all terms of the sequence. This property is a basic requirement in most fields of application, and this is why aggregation operators, defined on either real numbers or integers, are always required to be nondecreasing (see, e.g., any kind of means, median, order statistics, etc.). As it will be shown, not all computation rules are monotonic. The main result of this paper, shown in Section 3, is to give a characterization of the set of monotonic computation rules.

¹These will be revisited in Section 2 and formally defined in the proposed language formalism of [1].

2 Rules of Computation

We now recall the formalism of [1]. As we will only consider countable sequences of elements of \tilde{L} , without loss of generality, we may assume that $\tilde{L} = \mathbb{Z}$. In this way, elements of \tilde{L}^* are (finite) sequences of integers, denoted by $\sigma = (\lambda_i)_{i \in I}$ for some finite index set I , including the empty sequence ε , i.e.,

$$\tilde{L}^* = \left(\bigcup_{n \in \mathbb{N}} (\tilde{L})^n \right) \cup \{\varepsilon\}.$$

This convention will simplify our exposition and establish connections to the theory of integer means.

Also, as \otimes is commutative, the order of symbols in the word does not matter, and we can consider the decreasing order of the absolute values of the elements in the sequence (e.g., $5, 5, -5, -3, 2, -2, 1, 0$). Since sequences are ordered, we can consider the following convenient formalism for representing sequences. For an arbitrary sequence

$$\sigma = \underbrace{(n_1, \dots, n_1)}_{p_1 \text{ times}}, \underbrace{(-n_1, \dots, -n_1)}_{m_1 \text{ times}}, \dots, \underbrace{(n_q, \dots, n_q)}_{p_q \text{ times}}, \underbrace{(-n_q, \dots, -n_q)}_{m_q \text{ times}}$$

with $n_1 \geq \dots \geq n_q$, let $\theta(\sigma) = (n_1, \dots, n_q)$ be the sequence of absolute values (magnitudes) of integers in σ , and let $\psi(\sigma) = ((p_1, m_1), \dots, (p_q, m_q))$ be the sequence of pairs of numbers of occurrence of these integers. For instance, if $\sigma = (3, 3, -3, 2, -2, 1, 1, 1)$, then

$$\theta(\sigma) = (3, 2, 1); \quad \psi(\sigma) = ((2, 1), (1, 2)(4, 0)).$$

Let \mathfrak{S} denote the set of all integer sequences in this formalism, including the empty sequence, and let \mathfrak{S}_0 be the subset of all nonassociative sequences.

To facilitate the precise definition of rules of computation, we proposed [1] a language formalism over a 5-element alphabet made of 5 elementary rules $\rho_i : \mathfrak{S} \rightarrow \mathfrak{S}$ that act on σ in the following way:

- (i) Elementary rule ρ_1 : if $p_1 > 1$ and $m_1 > 0$, then p_1 is changed to $p_1 = 1$;
- (ii) Elementary rule ρ_2 : same as in (i) with p_1, m_1 exchanged;
- (iii) Elementary rule ρ_3 : if $p_1 > 0, m_1 > 0$, the pair (p_1, m_1) is changed into $(p_1 - c, m_1 - c)$, where $c = p_1 \wedge m_1$;
- (iv) Elementary rule ρ_4 : if $p_1 > 0, m_1 > 0$, and if $p_2 > 0$, then p_2 is changed into $p_2 = 0$;
- (v) Elementary rule ρ_5 : same as in (iv) with m_2 replacing p_2 .

Hence, elementary rules delete terms only in nonassociative sequences, and leave the associative ones invariant.

A (well-formed) computation rule R is a word built with the alphabet $\{\rho_1, \dots, \rho_5\}$, i.e., $R \in \mathcal{L}(\rho_1, \dots, \rho_5)$, such that $R(\sigma) \in \mathfrak{S} \setminus \mathfrak{S}_0$ for all $\sigma \in \mathfrak{S}$. The set of (well-formed) computation rules is denoted by \mathfrak{R} . Examples of rules are (words are read from left to right)

- (i) $\langle \cdot \rangle_{\pm}^+ = (\rho_4 \rho_5)^* \rho_1 \rho_2 \rho_3$, that corresponds to first putting parentheses around all positive terms and all negative terms, and then computing the symmetric maximum of the two results.
- (ii) $\langle \cdot \rangle_0 = \rho_3^*$, that corresponds to putting parentheses around each pair of maximal symmetric terms.
- (iii) $\langle \cdot \rangle_{=} = (\rho_1 \rho_2 \rho_3)^*$, that corresponds to putting parentheses around terms with the same absolute value and sign, and then to putting parentheses around each each pair of maximal symmetric resulting terms.

It is shown in [1] that each computation rule $R \in \mathfrak{R}$ corresponds to an arrangement of parentheses together with a permutation on the terms of sequences. Thus each $R \in \mathfrak{R}$ turns the symmetric maximum into an associative operation $\otimes_R : \tilde{L}^* \rightarrow \tilde{L}$ defined by $\otimes_R = \otimes \circ R$, since $R(\sigma) \in \mathfrak{S} \setminus \mathfrak{S}_0$ for all $\sigma \in \mathfrak{S}^2$. Moreover, each computation rule has the form $R = T_1 T_2 \dots$, where each T_i has the form $\omega \rho_1^\alpha \rho_2^\beta \rho_3$, with $\omega \in \mathcal{L}(\rho_4, \rho_5)$ and $\alpha, \beta \in \{0, 1\}$ (factorization scheme)³

Now, to compute $\otimes_R(\sigma)$ one needs to delete symbols in the sequence $\theta(\sigma)$ exactly as they are deleted in $\psi(\sigma)$. This entails an ordering of \mathfrak{R} that is discussed below.

Let $R, R' \in \mathfrak{R}$ and, for each sequence $\sigma = (a_i)_{i \in I}$, let $J_\sigma \subseteq I$ and $J'_\sigma \subseteq I$, be the sets of indices of the terms in σ deleted by R and R' , respectively. Then, we write $R \leq R'$ if for all sequences $\sigma \in \mathfrak{S}$ we have $J_\sigma \supseteq J'_\sigma$. Clearly, it is

²For convenience, we assume that $\otimes_R(\varepsilon) = 0$ and $\otimes_R(a) = a$, for every $a \in \tilde{L}$

³Here, $\rho^0 = \varepsilon$ and $\rho^1 = \rho$.

reflexive and transitive, and thus it is a preorder. This induces an equivalence relation \sim defined as follows: $R \sim R'$ if $R \leq R'$ and $R' \leq R$. The following proposition reassembles several results in [1], and provides equivalent definitions of \sim .

Proposition 1. Let $R, R' \in \mathfrak{R}$. Then the following assertions are equivalent.

- (i) $R \sim R'$.
- (ii) $\mathbb{O}_R = \mathbb{O}_{R'}$.
- (iii) $\text{Ker}(\mathbb{O}_R) = \text{Ker}(\mathbb{O}_{R'})$, where $\text{Ker}(\mathbb{O}_R)$ denotes the *kernel* of \mathbb{O}_R that is defined by

$$\text{Ker}(\mathbb{O}_R) = \{\sigma \in \mathfrak{S} \mid \mathbb{O}_R(\sigma) = 0\}.$$

Furthermore, any two equivalent rules have exactly the same “factorized irredundant form”. Recall that a rule $R \in \mathfrak{R}$ is considered in *factorized irredundant form (FIF)* if the two following conditions are verified:

- (i) **Factorization:** R can be factorized into a composition

$$R = T_1 T_2 \cdots T_i \cdots \quad (2)$$

where each term has the form $T_i = \omega_i \rho_1^{a_i} \rho_2^{b_i} \rho_3$, with $\omega_i \in \mathcal{L}(\{\rho_4, \rho_5\})$ (possibly empty), and $a_i, b_i \in \{0, 1\}$.

- (ii) **Simplification:** Suppose that in (2) there exists $j \in \mathbb{N}$ such that $\omega_j = \omega \rho_4^*$ or $\omega \rho_5^*$ for some $\omega \in \mathcal{L}(\{\rho_4, \rho_5\})$, or that ρ_4 and ρ_5 alternate infinitely many times in ω_j . Let

$$\begin{aligned} k_1 &= \min\{j : \omega_j = \omega \rho_4^* \text{ or } \omega \rho_5^*\}, \quad \text{and} \\ k_2 &= \min\{j : \rho_4 \text{ and } \rho_5 \text{ alternate infinitely many times in } \omega_j\}. \end{aligned}$$

- If $k_1 < k_2$, then $R \sim T_1 \cdots T_{k_1}$.
- Otherwise, $k_2 \leq k_1$, and $R \sim T_1 \cdots T'_{k_2}$, where $T'_{k_2} = (\rho_4 \rho_5)^* \rho_1^{a_{k_2}} \rho_2^{b_{k_2}} \rho_3$.

Observe that every non-terminal term T_j (i.e., of the form $\omega \rho_1^a \rho_2^b \rho_3$) in a rule in FIF has a “certificate”.

Certificates can be defined recursively as follows. A *certificate* γ of non-terminal term $T = \omega \rho_1^a \rho_2^b \rho_3$ is an element of $\text{Ker}(T)$ such that no letter of T is left unused (unread or without deleting an element of γ) when γ is deleted. For instance, consider $T = \rho_4 \rho_5^2 \rho_4 \rho_3$. Then $\sigma = (1, 1)(2, 1)(0, 1)$ is a kernel element but not a certificate, while $\gamma = (1, 1)(2, 1)(1, 1)$ is a certificate.⁴ The definition is then recursively extended to rules in \mathfrak{R}/\sim using factorization.

The structure of the poset \mathfrak{R}/\sim of equivalence classes endowed with the partial order induced by \leq was investigated in [1] and shown to be highly complex. To give an idea, the subposet \mathfrak{R}_{123}/\sim of equivalence classes of rules $R \in \mathcal{L}(\rho_1, \rho_2, \rho_3)$ has infinitely many maximal elements, and $(\mathfrak{R}_{123}/\sim, \leq)$ (and thus $(\mathfrak{R}/\sim, \leq)$) embeds the powerset $(2^{\mathbb{N}}, \subseteq)$ of natural numbers, and hence it is of continuum cardinality. For further results on \mathfrak{R}/\sim , see [1].

The complex structure of $(\mathfrak{R}/\sim, \leq)$ gives little hope to obtain a complete description of this poset. In addition to considering restrictions on the syntax of computation rules, another approach to provide local descriptions is to consider computation rules with certain desirable properties. One of such properties is monotonicity which is particularly relevant in applied mathematics, especially, in decision making and aggregation theory. In the next section we provide the explicit description of monotonic computation rules in terms of their factorized irredundant form (FIF).

3 Monotonic computation rules

In this section we aim to describe those computation rules that are monotonic. Recall that a rule $R \in \mathfrak{R}$ is *monotonic* if $\mathbb{O}_R(a_1, \dots, a_n) \leq \mathbb{O}_R(a'_1, \dots, a'_n)$, whenever $a_i \leq a'_i$ for every $n \in \mathbb{N}$ and $i = 1, \dots, n$. For instance, it is not difficult to see that both $\langle \cdot \rangle_0$ and $\langle \cdot \rangle_-$ are monotonic, however, $\langle \cdot \rangle_+$ is not:

$$\mathbb{O}_{\langle \cdot \rangle_+}(5, -5, -5, 4, 3) = 4 \quad \text{whereas} \quad \mathbb{O}_{\langle \cdot \rangle_-}(5, -5, -4, 4, 3) = 3.$$

In order to study monotonicity, first observe the following facts.

- (i) \mathbb{O}_R is monotonic for every rule R on $\mathfrak{S} \setminus \mathfrak{S}_0$. Hence, we can consider only sequences in \mathfrak{S}_0 .

⁴Note that a certificate exists if and only if ω neither contains ρ_4^* , ρ_5^* nor $(\rho_4 \rho_5)^*$.

- (ii) It is sufficient to study the effect of increasing one element of the sequence σ . If we increase n_k to $n > n_1$, then the sequence becomes associative, and the value of \mathbb{Q}_R is n . Hence, it is sufficient to consider an increase to any value at most n_1 .

Lemma 1. Let $\sigma \in \mathfrak{S}_0$. Then \mathbb{Q}_R is monotonic w.r.t. any element n_1 or $-n_1$ of the sequence, for any rule $R = T^1 T^2 \dots$ with $T^1 = \omega \rho_3$.

Proof. Suppose that an element n_1 is changed to $n'_1 > n_1$. Then the new sequence σ' becomes associative and $\mathbb{Q}_R(\sigma') = n'_1 > \mathbb{Q}_R(\sigma)$. Suppose now that an element $-n_1$ is changed to $-n_1 + \epsilon \leq -n_2$. Then (p_1, m_1) is changed to $(p_1, m_1 - 1)$, which can only increase the result of \mathbb{Q}_R , as ρ_1, ρ_2 are not present in T^1 . \square

Let us start with computation rules with a single term.

Lemma 2. If R has the form $(\rho_4 \rho_5)^* \rho_1^a \rho_2^b \rho_3$ then \mathbb{Q}_R is monotonic.

Proof. Let $\sigma \in \mathfrak{S}_0$. After the application of $(\rho_4 \rho_5)^*$ only the first term (p_1, m_1) remains, so that it is enough to study the effect of increasing $\pm n_1$. If n_1 is increased to n'_1 , then $\mathbb{Q}_R(\sigma') = n'_1$, and if $-n_1$ is increased, this can only increase the result of \mathbb{Q}_R . \square

Lemma 3. Let $R \in \mathfrak{R}$ be in FIF.

- (i) Suppose that R has the form $\omega \rho_1^a \rho_2^b \rho_3$ for $\omega = \omega' \rho_4^*$ with $\omega' \in \mathcal{L}(\rho_4, \rho_5)$. Then R is monotonic if and only if $(a, b) = (a, 0)$, for $a \in \{0, 1\}$, and $\omega' = \varepsilon$.
- (ii) Suppose that R has the form $\omega \rho_1^a \rho_2^b \rho_3$ for $\omega = \omega' \rho_5^*$ with $\omega' \in \mathcal{L}(\rho_4, \rho_5)$. Then R is monotonic if and only if $(a, b) = (0, b)$, for $b \in \{0, 1\}$, and $\omega' = \varepsilon$.

Proof. We show that (i) holds; the proof of (ii) is analogous. To see that the condition is necessary, suppose that $(a, b) = (a, 1)$, where $a \in \{0, 1\}$. Consider the sequence

$$\sigma_1 = (1, 2) \sigma_{\omega'} \sigma',$$

where $\sigma_{\omega'}$ is a certificate of ω' and σ' a sequence such that the difference between the smallest absolute value of $\sigma_{\omega'}$ and the greatest absolute value of σ' is at least 2. Then $\mathbb{Q}_R(\sigma_1) = -n$ for some $-n$ in σ' if it exists, or $\mathbb{Q}_R(\sigma_1) = 0$. Consider now the sequence

$$\sigma_2 = (1, 1) \sigma_{\omega'} (0, 1) \sigma',$$

obtained from σ by increasing $-n_1$ to $-n'$ greater than all $-n$ in $\sigma_{\omega'}$ and smaller than all $-n$ in σ' . Clearly, $\sigma_1 < \sigma_2$ but $\mathbb{Q}_R(\sigma_2) = -n' < \mathbb{Q}_R(\sigma_1)$.

To see that we must have $\omega' = \varepsilon$, suppose to the contrary that $\omega' \neq \varepsilon$. Hence, ω' has the form $\omega' = \omega'' \rho_5$, otherwise we would have $\omega' \rho_4^* = \rho_4^*$. Consider the sequences

$$\sigma = (1, 1) \sigma_{\omega''} (0, 1) (1, 0) < (1, 1) \sigma_{\omega''} (1, 0) (0, 1) = \sigma'$$

where σ' has been obtained from σ by increasing the last but one element $-n$ to $-n'$ s.t. $n' < n''$, with n'' the last element in σ . Then $\mathbb{Q}_R(\sigma) = 0 > \mathbb{Q}_R(\sigma') = -n'$, which contradicts the fact that R is monotonic. Hence, $\omega' = \varepsilon$.

To prove sufficiency, consider the case $(a, b) = (0, 0)$ (the case $(a, b) = (1, 0)$ is similar). Any sequence σ has the form $\sigma = (p_1, m_1)(p_2, 0) \dots (p_t, 0) \sigma'$ with $t \geq 0$. Note that (a) if $p_1 > m_1$, then $\mathbb{Q}_R(\sigma) = n_1$, (b) if $p_1 < m_1$, then $\mathbb{Q}_R(\sigma) = -n_1$ (smallest value), and (c) if $p_1 = m_1$, $\mathbb{Q}_R(\sigma) = -n$ if it exists in σ' , or $\mathbb{Q}_R(\sigma) = 0$. It is not difficult to check that, in each case, any increase in σ can only result in an increase of $\mathbb{Q}_R(\sigma)$. \square

We now extend our study to rules made of several terms, and we will make use of the two following auxiliary results to simplify our search for nonmonotonic rules.

Lemma 4. Suppose that \mathbb{Q}_R is not monotonic, and let $T \in \mathcal{L}(\rho_1, \dots, \rho_5)$ such that $TR \in \mathfrak{R}$ be in FIF. Then \mathbb{Q}_{TR} also is not monotonic.

Proof. Since $TR \in \mathfrak{R}$ is in FIF, $T = T_1 T_2 \dots T_i \dots$ is finite and each term T_j has a certificate σ_j . Hence, the composition $\sigma = \sigma_1 \sigma_2 \dots \sigma_i \dots$ is a certificate of T .

Suppose that \mathbb{Q}_R is not monotonic, and let σ' and σ'' be sequences such that $\sigma' < \sigma''$ and $\mathbb{Q}_R(\sigma') > \mathbb{Q}_R(\sigma'')$. Consider the two composite sequences $\sigma \sigma'$ and $\sigma \sigma''$. Clearly, $\sigma \sigma' < \sigma \sigma''$ but

$$\mathbb{Q}_{TR}(\sigma \sigma') = \mathbb{Q}_R(\sigma') > \mathbb{Q}_R(\sigma'') = \mathbb{Q}_{TR}(\sigma \sigma'').$$

In other words, \mathbb{Q}_{TR} is not monotone. \square

Lemma 5. Let $R \in \mathfrak{R}$ be in FIF, and let $T = \rho_3^k R$ with $k \geq 1$. Then, \mathbb{V}_R is monotonic if and only if \mathbb{V}_T is monotonic.

Proof. From Lemma 4 it follows that the condition is sufficient. Conversely, suppose that \mathbb{V}_R is monotonic. It suffices to prove that $\mathbb{V}_{\rho_3 R}$ is monotonic and apply k times the result. Consider any sequence $\sigma = (p_1, m_1)\sigma_1 \in \mathfrak{S}_0$. By Lemma 1, $\mathbb{V}_{\rho_3 R}$ is monotonic w.r.t. $\pm n_1$. Now, consider σ' obtained by increasing any element in σ_1 . Then

$$\sigma' = \begin{cases} (p_1, m_1)\sigma'_1 & \text{with } \sigma'_1 > \sigma_1 \\ (p_1 + 1, m_1)\sigma'_1 \end{cases}$$

In the first case, $\mathbb{V}_{\rho_3 R}(\sigma') = \mathbb{V}_{\rho_3 R}(\sigma)$ when $p_1 \neq m_1$, otherwise $\mathbb{V}_{\rho_3 R}(\sigma') = \mathbb{V}_R(\sigma'_1) \geq \mathbb{V}_R(\sigma_1)$ since R is monotonic.

In the second case, we have $\mathbb{V}_{\rho_3 R}(\sigma') > \mathbb{V}_{\rho_3 R}(\sigma)$ if $p_1 = m_1$ or $p_1 = m_1 - 1$, otherwise $\mathbb{V}_{\rho_3 R}(\sigma') = \mathbb{V}_{\rho_3 R}(\sigma)$. \square

Lemma 6. Let $R = T^1 T^2 \dots$ be in FIF where $T^i = \omega_i \rho_1^{a_i} \rho_2^{b_i} \rho_3$. If there exists k such that

- $(a_k, b_k) = (1, 0)$ and $\omega_k \neq \rho_4^*, (\rho_4 \rho_5)^*$,
- $(a_k, b_k) = (0, 1)$ and $\omega_k \neq \rho_5^*, (\rho_4 \rho_5)^*$, or
- $(a_k, b_k) = (1, 1)$ and $\omega_k \neq \rho_4^*, \rho_5^*, (\rho_4 \rho_5)^*$,

then \mathbb{V}_R is not monotonic.

Proof. Assuming that R is in FIF, by Lemma 4, we may assume that $k = 1$.

- Suppose that $(a_1, b_1) = (1, 0)$ and $\omega_1 \neq \rho_4^*, (\rho_4 \rho_5)^*$. Consider the sequences

$$\sigma_1 = (1, 1)(1, 0)^{|\omega_1|_{\rho_4}}(1, 0) \quad \text{and} \quad \sigma_2 = (2, 1)(1, 0)^{|\omega_1|_{\rho_4}}$$

obtained from σ_1 by augmenting $n_{|\omega_1|_{\rho_4}+2}$ to n_1 , where $|\omega_1|_{\rho_4}$ indicates the number of occurrences of ρ_4 in ω_1 . Although $\sigma_1 < \sigma_2$ we have

$$\mathbb{V}_R(\sigma_1) = n_{|\omega_1|_{\rho_4}+2} > 0 = \mathbb{V}_R(\sigma_2),$$

and thus \mathbb{V}_R is not monotonic.

- Suppose that $(a_1, b_1) = (0, 1)$ and $\omega_1 \neq \rho_5^*, (\rho_4 \rho_5)^*$. Consider the sequences

$$\sigma_1 = (1, 2)(0, 1)^{|\omega_1|_{\rho_5}} \quad \text{and} \quad \sigma_2 = (1, 1)(0, 1)^{|\omega_1|_{\rho_5}}(0, 1),$$

obtained from σ_1 by increasing the value $-n_1$ to $-n_{|\omega_1|_{\rho_5}+2}$. Clearly, $\sigma_1 < \sigma_2$ but $\mathbb{V}_R(\sigma_1) = 0 > -n_{|\omega_1|_{\rho_5}+2} = \mathbb{V}_R(\sigma_2)$, and thus \mathbb{V}_R is not monotonic.

- The remaining case $(a_1, b_1) = (1, 1)$ and $\omega_1 \neq \rho_4^*, \rho_5^*, (\rho_4 \rho_5)^*$ is dealt with similarly. \square

We now consider the case where $(a_i, b_i) = (0, 0)$ in each term $T^i = \omega_i \rho_1^{a_i} \rho_2^{b_i} \rho_3$.

Lemma 7. Suppose $R = T^1 T^2 \dots$ is in FIF, and that no term contains ρ_1 nor ρ_2 . If there is $k \geq 1$ such that ω_k in T^k is of the AFT type or equal to ρ_4^α or ρ_5^β , then \mathbb{V}_R is not monotonic.

Proof. By Lemma 4, it suffices to consider the case $k = 1$. Suppose first that $R = \omega \rho_3 R'$ with ω of the AFT type, say $\omega = \rho_4^{\alpha_1} \rho_5^{\beta_1} \dots \rho_4^{\alpha_t} \rho_5^{\beta_t}$. Consider the sequence

$$\sigma = (1, 1)(1, 0)^{\chi_1}(0, 1)^{\xi_1} \dots (1, 0)^{\chi_t}(0, 1)^{\xi_t}(1, 0)(1, 0).^5$$

Clearly, $\mathbb{V}_R(\sigma) = n_{t+2}$. Now let us increase the term with value n_{t+2} to n_j , where j is the first index such that $\chi_j = 1$, so that we obtain the sequence σ' . Clearly, we have $\sigma < \sigma'$ but $\mathbb{V}_R(\sigma) = n_{t+2} > n_{t+3} = \mathbb{V}_R(\sigma')$.

Now, w.l.o.g. suppose that $\omega = \rho_4^\alpha$ with $\omega \neq \rho_4^*$; the other case $\omega = \rho_5^\beta$ with $\omega \neq \rho_5^*$ is dealt with similarly. Consider $\sigma = (1, 1)(1, 0)^\alpha(1, 0)(1, 0)$ and σ' obtained from σ by increasing the value of $n_{\alpha+2}$ to n_2 , i.e.,

$$\sigma = (1, 1)(2, 0)(1, 0)^{\alpha-1}(1, 0).$$

In this case, we get $\mathbb{V}_R(\sigma) = n_{\alpha+2} > n_{\alpha+3} = \mathbb{V}_R(\sigma')$.

In both cases, we get that \mathbb{V}_R is not monotonic. \square

⁵Here $\chi_i = 1$ if $\alpha_i > 0$, otherwise $\chi_i = 0$. Similarly, $\xi_i = 1$ if $\beta_i > 0$, otherwise $\xi_i = 0$.

We can now provide a complete description of monotonic rules.

Theorem 2. Let $R \in \mathfrak{R}$ be in FIF. Then \mathbb{Q}_R is monotonic if and only if either

- (i) $R = \rho_3^*$, or
- (ii) $R = \rho_3^k T$, where $T = \omega \rho_1^a \rho_2^b \rho_3$ satisfies the following conditions
 - if $(a, b) = (1, 0)$, then $\omega = \rho_4^*$ or $(\rho_4 \rho_5)^*$,
 - if $(a, b) = (0, 1)$, then $\omega = \rho_5^*$ or $(\rho_4 \rho_5)^*$,
 - if $(a, b) = (1, 1)$, then $\omega = (\rho_4 \rho_5)^*$,
 - if $(a, b) = (0, 0)$, then $\omega = \rho_4^*, \rho_5^*, (\rho_4, \rho_5)^*$.

Proof. Let us prove that all rules in (i) and (ii) are monotonic. It was already established that $\mathbb{Q}_{\rho_3^*} = \langle \cdot \rangle_0$ is monotonic. As for (ii), by using Lemma 5, it suffices to prove monotonicity for $R = T$, which is obtained by Lemmas 2 and 3.

It remains to prove that no other rule is monotonic. As rules are in FIF, no term can exist after T . Moreover, by Lemmas 6 and 7, no term of the form $T' = \omega' \rho_1^{a'} \rho_2^{b'} \rho_3$ with $\omega' \in \mathcal{L}(\rho_4, \rho_5)$ finite can occur before T or before ρ_3^k . Furthermore, by Lemma 3, it is not possible to add a finite $\omega' \in \mathcal{L}(\rho_4, \rho_5)$ before T . Thus, every monotonic rule must be of one of the stated forms, and the proof of Theorem 2 is now complete. \square

References

- [1] Miguel Couceiro and Michel Grabisch. On the poset of computation rules for nonassociative calculus. *Order*, 30(1):269–288, 2013.
- [2] Miguel Couceiro and Michel Grabisch. On integer-valued means and the symmetric maximum. *Aequationes Mathematicae*, 91(2):353–371, 2017.
- [3] Michel Grabisch. The Möbius transform on symmetric ordered structures and its application to capacities on finite sets. *Discrete Mathematics*, 287(1-3):17–34, 2004.
- [4] C. D. Bennett, W. C. Holland, and G. J. Székely. Integer valued means. *Aequationes Mathematicae*, 88:137–149, 2014.
- [5] A. Kolmogoroff. Sur la notion de moyenne. *Atti delle Reale Accademia Nazionale dei Lincei Mem. Cl. Sci. Fis. Mat. Natur. Sez.*, 12:323–343, 1930.

STRUCTURES WITH NO FINITE MONOMORPHIC DECOMPOSITION: APPLICATION TO THE PROFILE OF HEREDITARY CLASSES*

Djamila Oudrar

Faculty of Mathematics, USTHB, Algiers, Algeria
dabchiche@usthb.dz

Maurice Pouzet

Univ. Lyon, Université Claude-Bernard Lyon1,
CNRS UMR 5208, Institut Camille Jordan, France,
University of Calgary, Maths and Stats,
Calgary, Alberta, Canada
pouzet@univ-lyon1.fr

Dedicated to the memory of Roland Fraïssé and Claude Frasnay

ABSTRACT

We present a structural approach of some results about jumps in the behavior of the profile (alias generating function) of hereditary classes of finite structures. We consider the following notion due to N.Thiéry and the second author. A *monomorphic decomposition* of a relational structure R is a partition of its domain $V(R)$ into a family of sets $(V_x)_{x \in X}$ such that the restrictions of R to two finite subsets A and A' of $V(R)$ are isomorphic provided that the traces $A \cap V_x$ and $A' \cap V_x$ have the same size for each $x \in X$. Let \mathcal{S}_μ be the class of relational structures of signature μ which do not have a finite monomorphic decomposition. We show that if a hereditary subclass \mathcal{D} of \mathcal{S}_μ is made of ordered relational structures then it contains a finite subset \mathfrak{A} such that every member of \mathcal{D} embeds some member of \mathfrak{A} . Furthermore, for each $R \in \mathfrak{A}$ the profile of the age $\mathcal{A}(R)$ of R (made of finite substructures of R) is at least exponential. We deduce that if the profile of a hereditary class of finite ordered structures is not bounded by a polynomial then it is at least exponential. This result is a part of classification obtained by Balogh, Bollobás and Morris (2006) for ordered graphs.

Keywords ordered set, well quasi-ordering, relational structures, profile, asymptotic enumeration, indecomposability, graphs, tournaments, permutations.

1 Introduction and presentation of the results

The *profile* of a class \mathcal{C} of finite relational structures is the integer function $\varphi_{\mathcal{C}}$ which counts for each non negative integer n the number of members of \mathcal{C} on n elements, isomorphic structures being identified. The behavior of this function has been discussed in many papers, particularly when \mathcal{C} is *hereditary* (that is contains every substructure of any member of \mathcal{C}) and is made of graphs (directed or not), tournaments, ordered sets, ordered graphs or ordered hypergraphs. Furthermore, thanks to a result of Cameron [7], it turns out that the line of study about permutations (see [1]) originating in the Stanley-Wilf conjecture, solved by Marcus and Tardös (2004) [20], falls under the frame of the profile of hereditary classes of ordered relational structures (see [23, 25]). The results show that the profile cannot be arbitrary: there are jumps in its possible growth rate. Typically, its growth is polynomial or faster than every polynomial ([29] for ages, see [34] for a survey) and for several classes of structures, it is either at least exponential (e.g. for tournaments [4, 6], ordered graphs and hypergraphs [2, 3, 16] and permutations [14]) or at least with the growth of the partition function (e.g. for graphs [5]). For more, see the survey of Klazar [17].

In this paper, we consider hereditary classes of ordered relational structures. We describe those with polynomially bounded profile, we identify those with unbounded polynomial profile which are minimal w.r.t. inclusion and prove that their profile is exponential. The case of ordered binary relational structures and particularly the case of ordered

*The first author was supported by CMEP-Tassili grant.

irreflexive directed graphs are treated in Chapter 8 of [22] and are presented in [26]. On the surface, the cases of ordered binary relational structures and the case of ordered relational structures are similar. But the case of ternary relations is more involved.

Let us present our main results. Each structure we consider is of the form $R := (V, \leq, (\rho_j)_{j \in J})$, where \leq is a linear order on V and each ρ_j is a n_j -ary relational structure on V , that is a subset of V^{n_j} for some non-negative integer n_j , the *arity* of ρ_j . We will say that the sequence $\mu := (n_j)_{j \in J}$ is the *restricted signature* of R . The *age* of R is the set $\mathcal{A}(R)$ consisting of the structures induced by R on the finite subsets of V , these structures being considered up to isomorphy. A relational structure of the form (V, \leq) where \leq is a linear order on V is a *chain*; if it is of the form $B := (V, \leq, \leq')$ where \leq and \leq' are two linear orders on V this is a *bichain*, and if it is of the form $G := (V, \leq, \rho)$ where ρ is a binary relation this is an *ordered directed graph*. Chains, bichains and ordered directed graphs are the basic examples of ordered structures.

An *interval decomposition* of R is a partition \mathcal{P} of V into intervals I of the chain $C := (V, \leq)$ such that for every integer n and every pair A, A' of n -element subsets of V , the induced structures on A and A' are isomorphic whenever the traces $A \cap I$ and $A' \cap I$ have the same number of elements for each interval I . For example, if R is the bichain (V, \leq, \leq') , \mathcal{P} is an interval decomposition of V iff each block I is an interval for each of the two orders and they coincide or are opposite on I (see [21]). If a relational structure R has an interval decomposition into finitely many blocks, say $k + 1$, then trivially, the profile of $\mathcal{A}(R)$ is bounded by some polynomial whose degree is, at most, k . According to a result of [35] this must be a *quasi-polynomial*, that is a sum $a_k(n)n^k + \dots + a_0(n)$ whose coefficients $a_k(n), \dots, a_0(n)$ are periodic functions. Here, we show that this is in fact a polynomial.

We prove that essentially the converse holds.

Theorem 1.1. *Let \mathcal{C} be a hereditary class of finite ordered relational structures with a finite restricted signature μ . Then, either there is some integer k such that every member of \mathcal{C} has an interval decomposition into at most $k + 1$ blocks, in which case \mathcal{C} is a finite union of ages of ordered relational structures, each having an interval decomposition into at most $k + 1$ blocks, and the profile of \mathcal{C} is a polynomial, or the profile of \mathcal{C} is at least exponential.*

The jump of the growth of profile from polynomial to exponential was obtained for bichains by Kaiser and Klazar [14] and extended to ordered graphs by Balogh, Bollobás and Morris (2006) (Theorem 1.1 of [3]). Their results go much beyond exponential profile.

The first step of the proof of Theorem 1.1 is a reduction to the case where \mathcal{C} is of the form $\mathcal{A}(R)$. For that, we prove the following lemma:

Lemma 1.2. *If a hereditary class \mathcal{C} of finite ordered relational structures with a finite signature μ contains for every integer k some finite structure which has no interval decomposition into at most $k + 1$ blocks, then it contains a hereditary class \mathcal{A} with the same property which is minimal w.r.t. inclusion.*

Clearly, \mathcal{A} cannot be the union of two proper hereditary classes, hence it must be up-directed w.r.t. embeddability. Thus, according to an old and well know result of Fraïssé [8] p.279, this is the age of some relational structure R . Clearly, R is ordered and does not have a finite interval decomposition. Hence our reduction is done.

For the second step, we introduce the class \mathcal{D}_μ of ordered relational structures of signature μ , μ finite, which do not have a finite interval decomposition. We define an equivalence relation \equiv_R on the domain of a relational structure R whose classes form a monomorphic decomposition, a notion previously introduced in [35]. This equivalence is an intersection of equivalences $\equiv_{k,R}$. When R is ordered, there is some integer k such that \equiv_R and $\equiv_{k,R}$ coincide. Using Ramsey's theorem, we prove that

Theorem 1.3. *There is a finite subset \mathfrak{A} made of incomparable structures of \mathcal{D}_μ such that every member of \mathcal{D}_μ embeds some member of \mathfrak{A} .*

Note that if \mathcal{D} is the subclass of \mathcal{D}_μ made of bichains then $\mathfrak{A} \cap \mathcal{D}$ has twenty elements [21]. If \mathcal{D} is made of ordered reflexive (or irreflexive) directed graphs, $\mathfrak{A} \cap \mathcal{D}$ contains 1246 elements (cf Theorem 8.23 of [26]).

The members of \mathfrak{A} have a special form. There are almost multichainable (a notion introduced by the second author in his thèse d'État [29] which appeared in [32] and [30]).

Next, we prove that the profile of members of \mathfrak{A} grows at least exponentially.

Theorem 1.4. *: If $R \in \mathcal{D}_\mu^{(k)}$ then the profile φ_R is at least exponential. Indeed, for n large enough it satisfies $\varphi_R(n) \geq d \cdot c^n$ where c is the largest solution of $X^{k+1} - X^k - 1 = 0$ and d is a positive constant depending upon k .*

In the case of ordered undirected graphs, it was proved in [3] that it grows as fast as the Fibonacci sequence.

From Lemma 1.2 and Theorem 1.1, we can deduce the following.

Corollary 1.5. *If the profile of a hereditary class \mathcal{C} of finite ordered relational structures (with a finite restricted signature μ) is not bounded by a polynomial then it contains a hereditary class \mathcal{A} with this property which is minimal w.r.t. inclusion.*

Proof. If the profile of \mathcal{C} is not bounded by a polynomial then for every integer k it contains some finite structure which has no interval decomposition into at most $k + 1$ blocks. According to Lemma 1.2 it contains a hereditary class \mathcal{A} with this property which is minimal w.r.t. inclusion. As already observed, there is some R such that $\mathcal{A} = \mathcal{A}(R)$. According to Theorem 1.1, the profile of \mathcal{A} is exponential. Since the profile of every proper subclass of \mathcal{A} is bounded by a polynomial, \mathcal{A} is minimal. \square

This result holds for arbitrary hereditary classes of relational structures (provided that their arity is finite). It appears in a somewhat equivalent form as Theorem 0.1 of [35]. It is not trivial, the main argument relies on a result going back to the thesis of the second author [29], namely Lemma 4.1 p. 23 of [35]. No complete proof has been yet published. The proof of Corollary 1.5 is complete.

The proof of Lemma 1.2 relies on properties of well-quasi-ordering and of ordered structures. The proof of Theorem 1.3 relies on Ramsey's theorem. These results are part of the study of monomorphic decompositions of a relational structure, a notion introduced in [35] in the sequel of R. Fraïssé who invented the notion of monomorphy and C. Frasnay who proved the central result about this notion [9]. Indeed, an ordered relational structure has a finite interval decomposition iff it has a finite monomorphic decomposition. The profile of a class of finite relational structures, not necessarily ordered, each admitting a finite monomorphic decomposition in at most $k + 1$ blocks, is the union of finitely many ages of relational structures admitting a finite monomorphic decomposition in at most $k + 1$ blocks and is a quasi-polynomial (this is the main result of [35]). Lemma 1.2 extends. But, we do not know if Theorem 1.3 extends in general. We state that as a conjecture.

Let \mathcal{S}_μ be the class of all relational structures of signature μ , μ finite, without any finite monomorphic decomposition.

Conjecture 1.6. *There is a finite subset \mathfrak{A} made of incomparable structures of \mathcal{S}_μ such that every member of \mathcal{S}_μ embeds some member of \mathfrak{A} .*

The difficulty is with ternary structures. We may note that if one restricts \mathcal{S}_μ to tournaments, there is a set \mathfrak{A} with twelve elements [6]. The first author has shown that the conjecture holds if \mathcal{S}_μ consists of binary structures. She proved that for ordered reflexive graphs, \mathfrak{A} contains 1242 elements. We show that if we consider the class of undirected graphs, \mathfrak{A} has ten elements. The proof is easy, we give it in order to illustrate in a simple setting the technique used in the proof of Theorem 1.3. We may note that a graph has a finite monomorphic decomposition iff it decomposes into a finite lexicographic sum of cliques and independent sets. Hence our latter result can be stated as follows:

Proposition 1.7. *There are ten infinite graphs such that a graph does not decompose into a finite lexicographic sum of cliques and independent sets iff it contains a copy of one of these ten graphs.*

We may note that some of these graphs have polynomial profile, hence our machinery is not sufficient to illustrate the jump in profile beyond polynomials.

Results of this paper are included in Chapter 7 of the thesis of the first author [26]. They have been presented in part at ICGT 2014 (June 30-July 4 2014, Grenoble) [24]. Proofs are included in the full version of the paper.

Acknowledgement

We thank an anonymous referee who pointed out an analogy between the jumps in profile of finite structures and the Main Gap Theorem of Shelah for infinite structures, showing that exponential growth is obtained for unstable theories, and referred to [36] and [12].

References

- [1] M.H. Albert and M.D. Atkinson, Simple permutations and pattern restricted permutations. *Discrete Mathematics*, **300** (2005) 1–15.
- [2] J. Balogh, B. Bollobás and R. Morris, Hereditary properties of partitions, ordered graphs and ordered hypergraphs. *European Journal of Combinatorics*, **8**, (2006) 1263–1281.
- [3] J. Balogh, B. Bollobás and R. Morris, Hereditary properties of ordered graphs, in Topics in discrete mathematics, 179–213, Algorithms Combin., 26, Springer, Berlin, 2006.

- [4] J. Balogh, B. Bollobás and R. Morris, Hereditary properties of tournaments. *Electron. J. Combin.* **14** (2007), no. 1, Research Paper 60, 25 pp.
- [5] J. Balogh, B. Bollobás, M. Saks and V. T. Sós, The unlabelled speed of a hereditary graph property. *J. Combinatorial Theory*, series B **99** (2009) 9–19.
- [6] Y. Boudabous and M. Pouzet, The morphology of infinite tournaments; application to the growth of their profile. *European Journal of Combinatorics*. **31** (2010) 461–481.
- [7] P. J. Cameron, Homogeneous permutations. *Permutation patterns* (Otago, 2003). *Electron. J. Combin.* **9** (2002/03), no. 2, Research paper 2, 9 pp.
- [8] R. Fraïssé, *Theory of relations*. Second edition, North-Holland Publishing Co., Amsterdam, 2000.
- [9] C. Frasnay, *Quelques problèmes combinatoires concernant les ordres totaux et les relations monomorphes*. Thèse. Paris. *Annales Institut Fourier Grenoble* **15** (1965), pp. 415–524.
- [10] C. Frasnay, Détermination du degré optimal d_m de monomorphie pour les structures relationnelles au plus m-aires. *Math. Rep. Acad. Sci. Canada* vol.12 (4) p.141–146.
- [11] D.H. Gottlieb, A class of incidence matrices, *Proc. Amer. Math. Soc.* **17** (1966), 1233–1237.
- [12] B. Hart, E.Hrushovski, M.C. Laskowski, The uncountable spectra of countable theories. *Ann. of Math.* (2) **152** (2000), no. 1, 207–257.
- [13] G. Higman, Ordering by divisibility in abstract algebras. *Proc. London Math. Soc.*, (3) **2** (1952) 326–336.
- [14] T. Kaiser, M. Klazar, On growth rates of closed permutation classes. *Permutation patterns* (Otago, 2003). *Electron. J. Combin.* **9** (2002/03), no. 2, Research paper 10, 20 pp.
- [15] W. Kantor, On incidence matrices of finite projection and affine spaces, *Math.Zeitschrift* **124** (1972), 315–318.
- [16] M. Klazar, On growth rates of permutations, set partitions, ordered graphs and other objects. *Electron. J. Combin.* **15** (2008), no. 1, Research Paper 75, 22 pp.
- [17] M. Klazar, Overview of general results in combinatorial enumeration, in *Permutation patterns*, London Math. Soc. Lecture Note Ser., Vol. 376, (2010), 3–40, Cambridge Univ. Press, Cambridge.
- [18] G. Lopez, Sur la détermination d’une relation par les types d’isomorphie de ses restrictions. *C. R. Acad. Sci. Paris Sér. A-B* **275** (1972) A951–A953.
- [19] G. Lopez, L’indéformabilité des relations et multirelations binaires. *Z. Math. Logik Grundlag. Math.* **24** (1978), no. 4, 303–317.
- [20] A. Marcus, G. Tardös, Excluded permutation matrices and the Stanley-Wilf conjecture, *J. Combin. Theory*, Ser. A **107** (2004), 153–160.
- [21] T. Monteil and M. Pouzet, From the complexity of infinite permutations to the profile of bichains. In *ROGICS’08: International Conference on Relations, Orders and Graphs: Interaction with Computer Science*, pages 1–6, 2008.
- [22] D. Oudrar, Sur l’énumération de structures discrète. Une approche par la théorie des relations. *Thèse de Doctorat. Université des sciences et de la technologie Houari Boumediene, U.S.T.H.B., Alger (28 Septembre 2015)* 248 pages. Available at arXiv:1604.05839[math.CO].
- [23] D. Oudrar, M. Pouzet, Profile and hereditary classes of relational structures, *Proceedings ISOR’11, International Symposium on Operational Research, Algiers, Algeria, May 30-June 2, 2011*, H.Ait Haddadene, I.Bouchemakh, M.Boudar, S.Bouroubi (Eds)LAID3.
- [24] D. Oudrar, M. Pouzet, *Décomposition monomorphe des structures relationnelles et profil de classes héréditaires*. 7 pp, 2014, arXiv:1409.1432[math.CO].
- [25] D.Oudrar, M.Pouzet, Profile and hereditary classes of relational structures, *J. of MVLSC* Volume 27, Number 5-6 (2016), pp. 475-500.
- [26] D.Oudrar, Hereditary classes of ordered binary structures, preprint, 28pp. dec.2018.
- [27] M. Pouzet, Un belordre d’abritement et ses rapports avec les bornes d’une multirelation. *Comptes rendus Acad. Sci. Paris, Sér A* **274** (1972), pp. 1677–1680.
- [28] M. Pouzet, Application d’une propriété combinatoire des parties d’un ensemble aux groupes et aux relations, *Math. Zeitschr.* **150** (1976), no. 2, 117–134.
- [29] M. Pouzet, *Sur la théorie des relations*, Thèse d’État, Université Claude-Bernard, Lyon 1, 1978.
- [30] M. Pouzet, Relation minimale pour son âge. *Z. Math. Logik Grundlag. Math.* **25** (1979), 315–344.

- [31] M. Pouzet, The asymptotic behavior of a class of counting functions. *Combinatorics 79 Part 2*. M.Deza and I.G.Rosenberg, Eds., *Annals of Discrete Math.* **9** (1980), 223–224.
- [32] M. Pouzet, Relation impartible. *Dissertationes* **103** (1981), 1–48.
- [33] M. Pouzet, Application de la notion de relation presque-enchaînable au dénombrement des restrictions finies d'une relation, *Z. Math. Logik Grundlag. Math.*, **27** (1981), 289–332.
- [34] M. Pouzet, The profile of relations, *Glob. J.Pure Applied Math.* **2** (2006) 237–272 (Proceedings of the 14th symposium of the Tunisian Mathematical Society, held in Hammamet, March 20-23, 2006).
- [35] M. Pouzet and N. M. Thiéry. Some relational structures with polynomial growth and their associated algebras I: Quasi-polynomiality of the profile. *Electron. J. Combin.*, **20**(2):Paper 1, 35, 2013.
- [36] S. Shelah, Classification theory and the number of nonisomorphic models, Volume 92, 2nd Edition, North Holland, 1990.

A NOTE ON THE BOOLEAN DIMENSION OF A GRAPH AND OTHER RELATED PARAMETERS

Maurice Pouzet

Univ. Lyon, Université Claude-Bernard Lyon1
CNRS UMR 5208, Institut Camille Jordan
43, Bd. du 11 Novembre 1918, 69622 Villeurbanne, France
Department of Mathematics and Statistics
University of Calgary, Calgary, Alberta, Canada
pouzet@univ-lyon1.fr

Hamza Si Kaddour

Univ. Lyon, Université Claude-Bernard Lyon1
CNRS UMR 5208, Institut Camille Jordan
43, Bd. du 11 Novembre 1918, 69622 Villeurbanne, France
sikaddour@univ-lyon1.fr

Bhalchandra D. Thatte *

Departamento de Matemática
Universidade Federal de Minas Gerais (UFMG)
Av. Antonio Carlos, 6627
Caixa Postal 702, Região Pampulha
Belo Horizonte - MG, CEP: 31270-901, Brasil
thatte@ufmg.br

ABSTRACT

We consider Boolean, binary and symplectic dimensions of a graph. We obtain an exact formula for the Boolean dimension of a tree in terms of a certain star decomposition. We relate the binary dimension to the $mr\text{rank}_2$ of a graph.

Keywords Graphs · Tournaments

1 Preliminaries

Let \mathbb{F}_2 be the 2-element field, identified with the set $\{0, 1\}$. Let U be a vector space over \mathbb{F}_2 , and B be a bilinear form over U . This form is *symmetric* if $B(x, y) = B(y, x)$ for all $x, y \in U$. A vector $x \in U \setminus \{0\}$ is *isotropic* if $B(x, x) = 0$; two vectors x, y are *orthogonal* if $B(x, y) = 0$. The form B is said to be *alternating* if each $x \in U$ is isotropic, in which case (U, B) is called a *symplectic space*. The form is a *scalar product* if U has an *orthonormal base* (made of non-isotropic and pairwise orthogonal vectors). If U has finite dimension, say k , we identify it with \mathbb{F}_2^k , the set of all k -tuples over $\{0, 1\}$; we suppose that the scalar product of two vectors $x := (x_1, \dots, x_k)$ and $y := (y_1, \dots, y_k)$ is $\langle x | y \rangle := x_1y_1 + \dots + x_ky_k$.

*Supported by CAPES Brazil (Processo: 88887.364676/2019-00); the stay of this author was supported by LABEX MILYON (ANR-10-LABX-0070) of Université de Lyon within the program "Investissements d'Avenir (ANR-11-IDEX-0007)" operated by the French National Research Agency (ANR).

The graphs we consider are undirected and have no loop. That is a graph is a pair (V, E) where E is a subset of $[V]^2$, the set of 2-element subsets of V . Elements of V are the *vertices* and elements of E are its *edges*. The graph G be given, we denote by $V(G)$ its vertex set and by $E(G)$ its edge set. For $u, v \in V(G)$, we write $u \sim v$ if there is an edge joining u and v . For a vertex $v \in V(G)$, we denote by $N(v)$ the set of vertices in G adjacent with v . We are going to define three notions of dimension of a graph. The graph does not need to be finite, but our main results are for finite graphs.

Definition 1.1. Let $B: U \times U \rightarrow \mathbb{F}_2$ be a symmetric bilinear form. Let G be a graph. We say that $\phi: V(G) \rightarrow U$ is a *representation* of G in (U, B) if for all $u, v \in V(G), u \neq v$, we have $u \sim v$ if and only if $B(\phi(u), \phi(v)) = 1$. The *binary dimension* of G is the least cardinal κ for which there exists a symmetric bilinear form B on a vector space U of dimension κ and exists a representation of G in (U, B) . The *symplectic dimension* of G is the least cardinal κ for which there exists a symplectic space (U, B) in which G has a representation. When the bilinear form is a scalar product, a representation is called a *Boolean representation*. The *Boolean dimension* of G is the least cardinal κ for which G has a Boolean representation in a space of dimension κ equipped with a scalar product.

For the Boolean representation and the Boolean dimension, we have the following equivalent definition (Proposition 3.1 of [2]).

Definition 1.2. Let G be a graph. A *Boolean representation* is a family $\mathcal{V} := (V_i)_{i < \kappa}$ of subsets of V such that $u \sim v$ if and only u and v belong to an odd number of V_i 's. The Boolean dimension is the minimum cardinality of the family \mathcal{V} for which such a representation exists. The *Boolean dimension* of G is denoted by $b(G)$.

This notion of Boolean dimension has been considered by Belkhechine et al. [2, 3] (see also [1, 7]) The symplectic dimension has also been considered by other authors, for example, [5, 6].

2 Boolean dimension of trees

In this section, we show that there is a nice combinatorial interpretation for the Boolean dimension of trees.

We mention the following result [Belkhechine et al. [3]]

Lemma 2.1. Let $G := (V, E)$ be a graph, with $V \neq \emptyset$. Let $f: V \rightarrow \mathbb{F}_2^m$ be a boolean representation of G . Let $S \subseteq V$ such that $S \neq \emptyset$. Suppose that for all $A \subseteq S, A \neq \emptyset$, there exists $v \in V \setminus A$ such that $|N(v) \cap A|$ is odd. Then $\{f(x) \mid x \in A\}$ is linearly independent.

This suggests the following definition.

Definition 2.2 (Belkhechine et al. [3]). Let $G := (V, E)$ be a graph. A set $U \subset V$ is called *independent (mod 2)* if for all $B \subseteq U, B \neq \emptyset$, there exists $u \in V \setminus B$ such that $|N_G(u) \cap B|$ is odd, where $N_G(u)$ denotes the neighbourhood of u in G ; otherwise U is said to be *dependent (mod 2)*. Let $a(G)$ denote the maximum size of an independent set (mod 2) in G . **From now, we omit (mod 2) unless it is necessary to talk about independence in the graph theoretic sense.**

Definition 2.3. Let $T := (V, E)$ be a tree. A *star decomposition* Σ of T is a family $\{S_1, \dots, S_k\}$ of subtrees of T such that each S_i is isomorphic to $K_{1,m}$ (a star) for some $m \geq 1$, the stars are mutually edge-disjoint, and their union is T . For a star decomposition Σ , let $t(\Sigma)$ be the number of trivial stars in Σ (stars that are isomorphic to $K_{1,1}$), and let $s(\Sigma)$ be the number of nontrivial stars in Σ (stars that are isomorphic to $K_{1,m}$ for some $m > 1$). We define the parameter $m(T) := \min_{\Sigma} \{t(\Sigma) + 2s(\Sigma)\}$ over all star decompositions Σ of T . A star decomposition Σ of T for which $t(\Sigma) + 2s(\Sigma) = m(T)$ is called an *optimal star decomposition* of T .

Theorem 2.4. For all trees T , we have $a(T) = b(T) = m(T)$.

We know that $a(G) \leq b(G)$ for all graphs G , and $b(T) \leq m(T)$ for all trees T . See Belkhechine et al. [3] for details.

The proof of Theorem 2.4 will depend on the following propositions.

Definition 2.5. A *cherry* in a tree T is a maximal subtree S isomorphic to $K_{1,m}$ for some $m > 1$ that contains m end vertices of T . We refer to a cherry with m edges as an m -cherry.

Proposition 2.6. Let $T := (V, E)$ be a tree that contains a cherry. If all proper subtrees T' of T satisfy $a(T') = m(T')$, then $a(T) = m(T)$.

Proof. Let $x \in V$ be the center of a k -cherry in T , with $N_T(x) = \{u_1, \dots, u_k, w_1, \dots, w_\ell\}$, where $d(u_i) = 1$ for all i , and $d(w_i) > 1$ for all i . Here $d(x)$ denotes the degree of vertex x . For each $i = 1$ to ℓ , let T_i be the maximal subtree that contains w_i but does not contain x .

First, we show that any optimal star decomposition of T in which x is not the center of a star can be transformed into an optimal star decomposition in which x is the center of a star. Consider an optimal star decomposition Σ in which x is

not the center of a star. Therefore, edges xu_i are trivial stars of Σ . Now if $k > 2$ or if there is a trivial star xw_i in Σ , then we could have improved $t(\Sigma) + 2s(\Sigma)$ by replacing all trivial stars containing x by their union, which is a star centered at x . Hence, assume that $k = 2$ and each w_i is the center of a nontrivial star S_i , which contains the edge xw_i . Now replace each S_i by $S'_i := S_i - xw_i$, and add a new star centered at x with edge set $\{xw_1, \dots, xw_\ell, xu_1, xu_2\}$. The new decomposition is also optimal.

Now consider an optimal star decomposition Σ in which x is the center of a star. The induced decompositions on T_i are all optimal since Σ is optimal. Let for each $i \in \{1, \dots, \ell\}$, let A_i be a maximum size independent set in T_i . Hence $|A_i| = a(T_i) = m(T_i)$ for all i , and $m(T) = 2 + \sum_i m(T_i) = 2 + \sum_i a(T_i)$. We show that $A := \{x, u_1\} \cup (\cup_i A_i)$ is a maximum size independent set in T .

Consider a non-empty set $B \subseteq A$. We show that there exists $v \in V$ such that $|N_T(v) \cap B|$ is odd. If $x \in B$, then we take $v = u_2$. If $B = \{u_1\}$, then we take $v = x$. In all other cases, $B_i := B \cap V_i$ is non-empty for some i , and $x \notin B$. We find $v \in V_i \setminus B_i$ such that $|N_{T_i}(v) \cap B_i|$ is odd. Now $|N_T(v) \cap B|$ is odd since $x \notin B$ and v is not adjacent to u_1 . Moreover, $|A| = m(T)$. \square

Proposition 2.7. *Let $T := (V, E)$ be a tree that contains a vertex y of degree 2 adjacent to a vertex z of degree 1. If $a(T - z) = m(T - z)$, then $a(T) = m(T)$.*

Proof. First, we show that $m(T) = m(T - z) + 1$. If there is an optimal star decomposition of $T - z - y$ in which x is the center of a star, then $m(T - z) = m(T - z - y)$ and $m(T) = m(T - z) + 1$, else $m(T - z) = m(T - z - y) + 1$ and $m(T) = m(T - z - y) + 2$.

Now we consider a maximum size independent set A' in $T - z$. We have $|A'| = a(T - z) = m(T - z)$. We define $A := A' \cup \{y\}$ if $y \notin A'$; and $A := A' \cup \{z\}$ if $y \in A'$. We show that A is independent in T .

Case 1: $y \notin A'$, hence $y \in A$ and $z \notin A$. Let $B \subseteq A, B \neq \emptyset$.

If $y \in B$, then $|N_T(z) \cap B|$ is odd.

If $y \notin B$, then $B \subseteq A'$, hence there exists $v \in V(T - z)$ such that $|N_{T-z}(v) \cap B|$ is odd, and $|N_T(v) \cap B|$ is odd.

Case 2: $y \in A'$, hence $z \in A$. Let $B \subseteq A, B \neq \emptyset$.

If $z \notin B$, then $B \subseteq A'$. Find $v \in V(T - z) \setminus B$ such that $|N_{T-z}(v) \cap B|$ is odd. Hence $|N_T(v) \cap B|$ is odd.

Now suppose that $z \in B$. If $B = \{z\}$, then $N_T(y) \cap B$ is odd. Otherwise, consider $(B \setminus \{z\})$, which is a subset of A' . Find $v \in V(T - z) \setminus (B \setminus \{z\})$ such that $|N_{T-z}(v) \cap (B \setminus \{z\})|$ is odd. If $v \neq y$, then $|N_T(v) \cap B|$ is odd, and $x \in B$. In this case, let $B' := (B \setminus \{z\}) \cup \{y\}$. This is a subset of A' . Find $u \in V(T - z) \setminus B'$ such that $|N_{T-z}(u) \cap B'|$ is odd. Since B' contains x and y , we conclude that u is not adjacent to any of y and z , hence $|N_T(u) \cap B|$ is odd.

Thus we have shown that A is independent. We have $a(T) \geq |A| = |A'| + 1 = m(T - z) + 1 = m(T)$. Since $a(T)$ cannot be more than $m(T)$, we have $a(T) = m(T)$. \square

Proof of Theorem 2.4. If a tree T has 2 vertices, then $a(T) = m(T) = 1$. Each tree with at least 3 vertices contains a cherry or a vertex of degree 2 adjacent to a vertex of degree 1. (This is seen by considering the second-to-last vertex of a longest path in a tree.) Now induction on the number of vertices, using Propositions 2.6 and 2.7 implies the result. \square

Remark 2.8. Fallat and Hogben [4] consider the problem of minimum rank of graphs, and obtain a combinatorial description for the minimum rank of trees. The connection between minimum rank and the binary dimension is made clear in the next section for arbitrary graphs. Here we only state that in case of trees, the Boolean dimension, binary dimension and the minimum rank coincide, thus the formula given above for the Boolean dimension gives yet another combinatorial description for the minimum rank of a tree.

3 Binary and symplectic dimensions

A graph G is called *reduced* if it has no isolated vertices and no two vertices have the same neighbourhood. Our definition is that from Godsil and Royle [6], where it is noted that there are slightly different definitions of 'reduced' in the literature.

Let $A(G)$ denote the adjacency matrix of G . We denote the rank of a matrix M over \mathbb{F}_2 by $\text{rank}_2(M)$, and define $\text{rank}_2(G) := \text{rank}_2(A(G))$. Let \mathcal{D}_n be the set of $n \times n$ matrices with non-diagonal entries 0 and diagonal entries 0 or 1. Suppose that $|V(G)| = n$. We define $\text{mrank}_2(G) := \min\{\text{rank}_2(D + A(G)) \mid D \in \mathcal{D}_n\}$. In the following propositions, we relate the binary and symplectic dimensions of a graph G to its rank and mrank, respectively.

Proposition 3.1. *Let G be a reduced graph on n vertices with adjacency matrix $A(G)$. The symplectic dimension of G is equal to $\text{rank}_2(G)$.*

Proof. The argument is essentially based on [6], where it is shown that there exists a symplectic representation in a vector space over \mathbb{F}_2 of dimension $r := \text{rank}_2(G)$.

As shown in [6], it is possible to write

$$A(G) = \begin{pmatrix} M & H^T \\ H & N \end{pmatrix},$$

where the matrix M is the adjacency matrix of a reduced r -vertex graph of rank r , and $H = RM$, and $N = RHR^T = RMR^T$, which expresses the rows of the $(n-r) \times n$ matrix $(H \ N)$ as a linear combination of the rows of the $r \times n$ matrix $(M \ H^T)$. Rewriting, we have

$$A(G) = \begin{pmatrix} M & MR^T \\ RM & RMR^T \end{pmatrix} = \begin{pmatrix} I \\ R \end{pmatrix} M (I \ R^T),$$

where the matrix I is the $r \times r$ identity matrix. Thus M determines a non-degenerate symplectic form on \mathbb{F}_2^r given by $B(x, y) := x^T My$. Taking the columns of the $r \times n$ matrix $(I \ R^T)$ as the vertices of G , we obtain a representation of G in (\mathbb{F}_2^r, B) . Hence the symplectic dimension of G is at most r .

Now suppose that there is a symplectic representation ϕ of G in (\mathbb{F}_2^k, B) for some symplectic form B on \mathbb{F}_2^k . We show that $k \geq r$.

Writing $\phi(V(G)) := \{x_1, \dots, x_n\}$, where x_1, \dots, x_n are column vectors representing the vertices of G with respect to the standard basis, we can write $A(G) = X^T M X$, where M is the symmetric $k \times k$ matrix of the form B with respect to the standard basis $\{e_1, \dots, e_k\}$ (i.e., $M_{ij} = B(e_i, e_j)$), and $X := (x_1 \cdots x_n)$.

Now let $X := (P \ Q)$, where P is a $k \times k$ matrix (the first k columns of X) and Q is a $k \times (n-k)$ matrix (the last $n-k$ columns of X). Therefore,

$$A(G) = \begin{pmatrix} P^T \\ Q^T \end{pmatrix} M (P \ Q) = \begin{pmatrix} P^T \\ Q^T \end{pmatrix} (MP \ MQ).$$

Thus we have expressed the rows of $A(G)$ as linear combinations of the rows of the $k \times n$ matrix $(MP \ MQ)$, which implies that $k \geq r$. \square

Proposition 3.2. *Let G be a reduced graph on n vertices with adjacency matrix $A(G)$. The binary dimension of G is equal to $\text{mrank}_2(G)$.*

Proof. The proof of this proposition is similar to that of Proposition 3.1.

Let $D \in \mathcal{D}_n$. Suppose that the rank of $D + A(G) = r$. As in Proposition 3.1, we write

$$D + A(G) = \begin{pmatrix} M & H^T \\ H & N \end{pmatrix},$$

where the matrix M is a symmetric matrix of rank r (it is the adjacency matrix of a graph which possibly has loops but no multiple edges), and $H = RM$, and $N = RHR^T = RMR^T$, which expresses the rows of $(H \ N)$ as a linear combination of the rows of $(M \ H^T)$. Rewriting, we have

$$D + A(G) = \begin{pmatrix} M & MR^T \\ RM & RMR^T \end{pmatrix} = \begin{pmatrix} I \\ R \end{pmatrix} M (I \ R^T),$$

where the matrix I is the $r \times r$ identity matrix. Thus M determines a non-degenerate bilinear form on \mathbb{F}_2^r given by $B(x, y) := x^T My$. Taking the columns of $(I \ R^T)$ as the vertices of G , we obtain a representation of G in (\mathbb{F}_2^r, B) . Hence the binary dimension of G is at most r , which further implies that the binary dimension of G is at most $\text{mrank}_2(G)$ (by taking D that minimises $\text{rank}_2(D + A(G))$).

Next we show that the binary dimension is at least $\text{mrank}_2(G)$.

Let B be a bilinear form on \mathbb{F}_2^k , and suppose that there exists a representation ϕ of G in (\mathbb{F}_2^k, B) . We write $\phi(V(G)) := \{x_1, \dots, x_n\}$, where x_i are column vectors with respect to the standard basis of \mathbb{F}_2^k . Hence, for some D , we have $D + A(G) = X^T M X$, where M is the symmetric matrix of the bilinear form B . As in Proposition 3.1, we write

$$D + A(G) = \begin{pmatrix} P^T \\ Q^T \end{pmatrix} M \begin{pmatrix} P & Q \end{pmatrix} = \begin{pmatrix} P^T \\ Q^T \end{pmatrix} \begin{pmatrix} MP & MQ \end{pmatrix},$$

where P and Q are obtained from X as before.

Thus we have expressed the rows of $D + A(G)$ as linear combinations of the rows of the $k \times n$ matrix $\begin{pmatrix} MP & MQ \end{pmatrix}$, which implies that $k \geq \text{rank}_2(D + A(G)) \geq \text{mrank}_2(G)$. Hence the binary dimension of G is at least $\text{mrank}_2(G)$. \square

Acknowledgements

The third author would like to thank Institut Camille Jordan, Université Claude Bernard Lyon 1 for hospitality and support. Support from CAPES Brazil (Processo: : 88887.364676/2019-00) and Labex MILYON: ANR-10-LABX-0070 are gratefully acknowledged.

References

- [1] Houmen Belkhechine. Indécomposabilité des graphes et des tournois. *Thèse de doctorat, Université de Sfax et Université Claude-Bernard*. 15 Juillet 2009.
- [2] Houmen Belkhechine, Moncef Bouaziz, Imed Boudabbous and Maurice Pouzet. Inversion dans les tournois. *C.R. Acad. Sci. Paris, Ser. I* 348 (2010) 703–707.
- [3] Houmen Belkhechine, Moncef Bouaziz, Imed Boudabbous and Maurice Pouzet. Inversions in tournaments. Unpublished manuscript, 2012.
- [4] Shaun M Fallat and Leslie Hogben. The minimum rank of symmetric matrices described by a graph: a survey. *Linear Algebra and its Applications* 426 (2007), no. 2-3, 558–582.
- [5] Max H. Garzon. Symplectic embeddings of graphs. *Journal of Combinatorial Mathematics and Combinatorial Computing* 2 (1987), 193–207.
- [6] Chris D Godsil and Gordon F Royle. Chromatic number and the 2-rank of a graph. *Journal of Combinatorial Theory, Series B* 81 (2001), no. 1, 142–149.
- [7] Maurice Pouzet. Boolean dimension of a graph and inversions in tournaments, 2017, Slides of a talk to "40 Years of Graphs and Algorithms". *Workshop in honor of Michel Habib*. October 10-12, 2018, Irit, Paris.

Long papers

BIJECTIVE PROOFS FOR EULERIAN NUMBERS IN TYPES B AND D

Luigi Santocanale

LIS, CNRS UMR 7020, Aix-Marseille Université, France
luigi.santocanale@lis-lab.fr

ABSTRACT

Let $\langle \binom{n}{k} \rangle$, $\langle \binom{B_n}{k} \rangle$, and $\langle \binom{D_n}{k} \rangle$ be the Eulerian numbers in the types A, B, and D, respectively—that is, number of permutations of n elements with k descents, the number of signed permutations (of n elements) with k type B descents, the number of even signed permutations (of n elements) with k type D descents. Let $S_n(t) = \sum_{k=0}^{n-1} \langle \binom{n}{k} \rangle t^k$ and $B_n(t) = \sum_{k=0}^n \langle \binom{B_n}{k} \rangle t^k$, and $D_n(t) = \sum_{k=0}^n \langle \binom{D_n}{k} \rangle t^k$. We give bijective proofs of the identity

$$B_n(t^2) = (1+t)^{n+1} S_n(t) - 2^n t S_n(t^2).$$

and of Stembridge’s identity

$$D_n(t) = B_n(t) - n 2^{n-1} t S_{n-1}(t).$$

These bijective proofs rely on a representation of signed permutations as paths. Using the same representation we establish a bijective correspondence between even signed permutations and pairs (w, E) with $([n], E)$ a threshold graph and w a degree ordering of $([n], E)$.

1 Introduction

For $n \geq 0$, we use $[n]$ for the set $\{1, \dots, n\}$ and S_n for the set of permutations of n -elements—that is, bijections of $[n]$. We write a permutation $w \in S_n$ as a word $w_1 w_2 \dots w_n$ with $w_i \in [n]$ and $w_i \neq w_j$ for $i \neq j$. A *descent* of $w \in S_n$ is an index (or position) $i \in [n-1]$ such that $w_i > w_{i+1}$. The Eulerian number $\langle \binom{n}{k} \rangle$ counts the number of permutations $w \in S_n$ that have k descent positions. This is, of course, one among the many interpretations that we can give to these numbers, see e.g. [14]. The given interpretation is closely related to order theory. Let us recall that the set S_n can be endowed with a lattice structure, see e.g. [11, 6]. The lattice S_n is known under the name of Permutohedron or weak (Bruhat) order. Exploiting the bijection between descent positions and lower covers of $w \in S_n$, the Eulerian number $\langle \binom{n}{k} \rangle$ counts the number of permutations $w \in S_n$ with k lower covers. In particular, $\langle \binom{n}{1} \rangle = 2^n - n - 1$ is the number of join-irreducible elements in S_n . A subtler order-theoretic interpretation is given in [2]: since the S_n are (join-)semidistributive as lattices, every element can be written canonically as the join of join-irreducible elements [9]; the numbers $\langle \binom{n}{k} \rangle$ counts then the permutations $w \in S_n$ that can be written canonically as the join of k join-irreducible elements.

The symmetric groups S_n are particular instances of Coxeter groups, see [4]. Under the usual classification of finite Coxeter groups, the symmetric group S_n yields a concrete model for the Coxeter group A_{n-1} in the family A. Similarly to the symmetric groups, notions of length, descent, and inversion, and a weak order as well, can be defined for elements of an arbitrary Coxeter group [3]. We move our focus to the families B and D of Coxeter groups. More precisely, this paper concerns the Eulerian numbers in the types B and D. The Eulerian number $\langle \binom{B_n}{k} \rangle$ (resp., $\langle \binom{D_n}{k} \rangle$) counts the number of elements in the group B_n (resp., D_n) with k descent positions. Order-theoretic interpretations of these numbers, analogous to the ones mentioned for the standard Eulerian numbers, are still valid. As the abstract

group A_{n-1} has a concrete realization as the symmetric group S_n , the group B_n (resp., D_n) has a realization as the hyperoctahedral group of signed permutations (resp., the group of even signed permutations). Starting from these concrete representations of Coxeter groups in the types B and D, we pinpoint some new representations of signed permutations relying on which we provide bijective proofs of known formulas for Eulerian numbers in the types B and D. These formulas allow to compute the Eulerian numbers in the types B and D. from the better known Eulerian numbers in type A.

Let $S_n(t)$ and $B_n(t)$ be the Eulerian polynomials in the types A and B:

$$S_n(t) := \sum_{k=0}^{n-1} \left\langle \begin{matrix} n \\ k \end{matrix} \right\rangle t^k, \quad B_n(t) := \sum_{k=0}^n \left\langle \begin{matrix} B_n \\ k \end{matrix} \right\rangle t^k. \quad (1)$$

In [14, §13, p. 215] the following polynomial identity is stated:

$$2B_n(t^2) = (1+t)^{n+1}S_n(t) + (1-t)^{n+1}S_n(-t). \quad (2)$$

Considering that, for $f(t) = \sum_{k \geq 0} a_k t^k$,

$$f(t) + f(-t) = 2 \sum_{k \geq 0} a_{2k} t^{2k},$$

the polynomial identity (2) amounts to the following identity among coefficients:

$$\left\langle \begin{matrix} B_n \\ k \end{matrix} \right\rangle = \sum_{i=0}^{2k} \left\langle \begin{matrix} n \\ i \end{matrix} \right\rangle \binom{n+1}{2k-i}. \quad (3)$$

We present a bijective proof of (3) and also establish the identity

$$2^n \left\langle \begin{matrix} n \\ k \end{matrix} \right\rangle = \sum_{i=0}^{2k+1} \left\langle \begin{matrix} n \\ i \end{matrix} \right\rangle \binom{n+1}{2k+1-i}. \quad (4)$$

Considering that, for $f(t) = \sum_{k \geq 0} a_k t^k$,

$$f(t) - f(-t) = 2 \sum_{k \geq 0} a_{2k+1} t^{2k+1},$$

the identity (4) yields the polynomial identity:

$$2^{n+1} t S_n(t^2) = (1+t)^{n+1} S_n(t) - (1-t)^{n+1} S_n(-t).$$

More importantly, (3) and (4) jointly yield the polynomial identity

$$(1+t)^{n+1} S_n(t) = B_n(t^2) + 2^n t S_n(t^2). \quad (5)$$

Let now $D_n(t)$ be the Eulerian polynomial in type D:

$$D_n(t) := \sum_{k=0}^n \left\langle \begin{matrix} D_n \\ k \end{matrix} \right\rangle t^k.$$

Investigating further the terms $2^n S_n(t)$, we also ended up finding a simple bijective proof, that we present here, of Stembridge's identity [22, Lemma 9.1]

$$D_n(t) = B_n(t) - n 2^{n-1} t S_{n-1}(t), \quad (6)$$

which, in terms of the Eulerian numbers in type D, amounts to

$$\left\langle \begin{matrix} D_n \\ k \end{matrix} \right\rangle = \left\langle \begin{matrix} B_n \\ k \end{matrix} \right\rangle - n 2^{n-1} \left\langle \begin{matrix} n-1 \\ k-1 \end{matrix} \right\rangle.$$

Let us remark that the proofs presented here follow different paths from known proofs of the identities (2) and (6). As suggested in [14], the first identity may be derived by computing the f -vector of the type B Coxeter complex and then by applying the transform yielding h -vector from the f -vector. A similar method is used in [22] to prove the identity (6). On the other hand, our proofs directly rely on the combinatorial properties of signed/even signed permutations and on the representation of these objects that we call the path representation of a signed permutation and simply barred permutations.

2 Notation, elementary definitions, and facts

The notation used is chosen to be consistent with [14]. As mentioned before, we use $[n]$ for the set $\{1, \dots, n\}$ and S_n for the set of permutations of $[n]$. We use $[n]_0$ for the set $\{0, 1, \dots, n\}$, $[-n]$ for $\{-n, \dots, -1\}$, and $[\pm n]$ for $\{-n, \dots, -1, 1, \dots, n\}$. We write a permutation $w \in S_n$ as a word $w = w_1 w_2 \dots w_n$, with $w_i \in [n]$. For $w \in S_n$, its set of descents and its set of inversions¹ are defined follows:

$$\text{Des}(w) := \{i \in \{1, \dots, n-1\} \mid w_i > w_{i+1}\}, \quad \text{Inv}(w) := \{(i, j) \mid 1 \leq i < j \leq n, w^{-1}(i) > w^{-1}(j)\}.$$

Then, we let

$$\text{des}(w) := |\text{Des}(w)|.$$

The Eulerian number $\left\langle \begin{smallmatrix} n \\ k \end{smallmatrix} \right\rangle$, counting the number of permutations of n elements with k descents, can be formally defined as follows:

$$\left\langle \begin{smallmatrix} n \\ k \end{smallmatrix} \right\rangle := |\{w \in S_n \mid \text{des}(w) = k\}|.$$

Let us define a *signed permutation of $[n]$* as a permutation u of $[\pm n]$ such that, for each $i \in [\pm n]$, $u_{-i} = -u_i$. We use B_n for the set of signed permutations of $[n]$. When writing a signed permutation u as a word $u_{-n} \dots u_{-1} u_1 \dots u_n$, we prefer writing $u_i = \bar{x}$ in place of $-x$ if $u_i < 0$ and $|u_i| = x$. Also, we often write $u \in B_n$ in *window notation*, that is, we only write the suffix $u_1 u_2 \dots u_n$; indeed, the prefix $u_{-n} u_{-n-1} \dots u_{-1}$ is uniquely determined by the suffix $u_1 u_2 \dots u_n$, by mirroring it and by exchanging the signs. Obviously, the set B_n is a group and, as mentioned before, it is the standard model for a Coxeter group in the family B with n generators. Therefore, general notions from the theory of Coxeter groups (descent, inversion) apply to signed permutations. We present below as definitions the well-known explicit formulas for the descent and inversion sets of $u \in B_n$. We let

$$\text{Des}_B(u) := \{i \in \{0, \dots, n-1\} \mid u_i > u_{i+1}\}, \quad \text{Inv}_B(u) := \{(i, j) \mid 1 \leq |i| \leq j \leq n, u^{-1}(i) > u^{-1}(j)\},$$

where we set $u_0 := 0$, so 0 is a descent of u if and only if $u_1 < 0$,

$$\text{des}_B(u) = |\text{Des}_B(u)|, \quad \left\langle \begin{smallmatrix} B_n \\ k \end{smallmatrix} \right\rangle := |\{u \in B_n \mid \text{des}_B(u) = k\}|.$$

Finally, and recalling the definition in (1) of the Eulerian polynomials in the types A and B, let us mention that the type A Eulerian polynomial is often (for example in [5]) defined as follows:

$$A_n(t) := \sum_{k=1}^n \left\langle \begin{smallmatrix} n \\ k-1 \end{smallmatrix} \right\rangle t^k = t S_n(t).$$

We shall exclusively manipulate the polynomials $S_n(t)$ and not the $A_n(t)$. Notice that $S_n(t)$ has degree $n-1$ and $B_n(t)$ has degree n .

We shall introduce later even signed permutations and their groups, as well as related notions arising from the fact that these groups are standard models for Coxeter groups in the family D.

For the time being, let us observe the following. For $u \in B_n$ we let $\text{Des}_B^+(u) := \text{Des}_B(u) \setminus \{0\}$ —thus $\text{Des}_B^+(u)$ is the set of strictly positive descents of u . We have then:

Lemma 2.1. $|\{u \in B_n \mid \text{Des}_B^+(u) = k\}| = 2^n \left\langle \begin{smallmatrix} n \\ k \end{smallmatrix} \right\rangle$.

Proof. By considering its window notation, a signed permutation u yields a mapping $\tilde{u} : [n] \rightarrow [\pm n]$ with a unique decomposition of the form $\tilde{u} = \iota \circ w$ with $w \in S_n$ and $\iota : [n] \rightarrow [\pm n]$ an order preserving injection such that $x \in \iota([n])$ iff $-x \notin \iota([n])$. The monotone injections with this property are uniquely determined by their positive image $\iota([n]) \cap [n]$, so there are 2^n such injections. Moreover, for $i = 1, \dots, n-1$, $w_i > w_{i+1}$ if and only if $u_i > u_{i+1}$, so $|\text{Des}_B^+(\iota \circ w)| = |\text{Des}(w)|$. \square

¹It is also possible to define $\text{Inv}(w)$ as the set $\{(i, j) \mid 1 \leq i < j \leq n, w_i > w_j\}$. We stick in this paper to the one given here.

3 Path representation of signed permutations, simply barred permutations

We present here our combinatorial tools to deal with signed permutations, the path representation and the simply barred permutations.

Definition 3.1. The *path representation* of $u \in \mathbb{B}_n$ is a triple $(\pi^u, \lambda_x^u, \lambda_y^u)$ where π^u is a discrete path, drawn on a grid $[n]_0 \times [n]_0$ and joining the point $(0, n)$ to the point $(n, 0)$, $\lambda_x^u : [n] \rightarrow [n]$, and $\lambda_y^u : [n] \rightarrow [-n]$. The triple $(\pi^u, \lambda_x^u, \lambda_y^u)$ is constructed from u according to the following algorithm: (i) u is written in full notation as a word and scanned from left to right: each positive letter yields an East step (a length 1 step along the x -axis towards the right), and each negative letter yields a South step (a length 1 step along the y -axis towards the bottom); (ii) the labelling $\lambda_x^u : [n] \rightarrow [n]$ is obtained by projecting each positive letter on the x -axis, (iii) the labelling $\lambda_y^u : [n] \rightarrow [-n]$ is obtained by projecting each negative letter on the y -axis.

Example 3.2. Consider the signed permutation $u := \bar{2}31\bar{6}\bar{4}\bar{7}5$, in window notation, that is, $\bar{5}74\bar{6}\bar{1}\bar{3}\bar{2}\bar{2}\bar{3}1\bar{6}\bar{4}\bar{7}5$, in full notation. Applying the algorithm above, we draw the path π^u and the labellings λ_x^u, λ_y^u as follows:

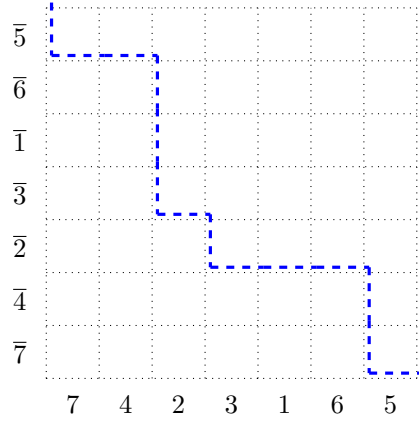

Therefore, π^u is the dashed blue path, λ_x^u is the permutation 7423165, and λ_y^u is $\bar{7}\bar{4}\bar{2}\bar{3}\bar{1}\bar{6}\bar{5}$. ◇

It is easily seen that, for an arbitrary $u \in \mathbb{B}_n$, $(\pi^u, \lambda_x^u, \lambda_y^u)$ has the following properties:

- (i) π^u is symmetric along the diagonal,
- (ii) $\lambda_x^u \in \mathbb{S}_n$ and, moreover, it is the subword of u of positive letters,
- (iii) for each $i \in [n]$, $\lambda_y^u(i) = \overline{\lambda_x^u(i)}$ and, moreover, λ_y^u is the mirror of the subword of u of negative letters.

In particular, we see that the data $(\pi^u, \lambda_x^u, \lambda_y^u)$ is redundant, since we could give away λ_y^u which is completely determined from λ_x^u .

Proposition 3.3. *The mapping $u \mapsto (\pi^u, \lambda_x^u)$ is a bijection from the set of signed permutations \mathbb{B}_n to the set of pairs (π, w) , where $w \in \mathbb{S}_n$ and π is a discrete path from $(0, n)$ to $(n, 0)$ with East and South steps which, moreover, is symmetric along the diagonal.*

We leave the reader convince himself of the above statement. Let us argue that the path representation of a signed permutation is, possibly, the more interesting combinatorial representation available to represent signed permutations. For example, the type B inversions of u can be identified with the type A inversions of λ_x^u and the unordered pairs or singletons $\{w_i, w_j\}$ with $1 \leq i \leq j \leq n$ such that the square (i, j) lies below π^u (we index squares from left to right and from bottom to top). Indeed, (i, j) lies below π^u if and only if (j, i) does, by symmetry of π^u .

With respect to Example 3.2, the set of type B inversions of $\bar{2}31\bar{6}\bar{4}\bar{7}5$ is the disjoint union of the set of type A inversions of 7423165 and the set

$$\{(-7, 7), (-4, 7), (-2, 7), (-3, 7), (-1, 7), (-6, 7), (-4, 4), (-2, 4), (-3, 4), (-1, 4), (-4, 6), (-2, 2)\}$$

corresponding to the set of unordered pairs

$$\{\{7, 7\}, \{7, 4\}, \{7, 2\}, \{7, 3\}, \{7, 1\}, \{7, 6\}, \{4, 4\}, \{4, 2\}, \{4, 3\}, \{4, 1\}, \{4, 6\}, \{2, 2\}\}.$$

Let us argue for this formally.

Proposition 3.4. Let $u \in \mathbb{B}_n$. For each i, j with $1 \leq |i| \leq j \leq n$, $(i, j) \in \text{Inv}_{\mathbb{B}}(u)$ if and only if either $1 \leq i < j \leq n$ and $(i, j) \in \text{Inv}(\lambda_x^u)$ or $i < 0$ and $((\lambda_x^u)^{-1}(i), (\lambda_x^u)^{-1}(j))$ appears below π^u .

Proof. Let in the following $w = \lambda_x^u$. If $i > 0$, then the statement that $(i, j) \in \text{Inv}_{\mathbb{B}}(u)$ if and only if $(i, j) \in \text{Inv}(w)$ follows since w is the subword of u (written in full notation) of positive integers. On the other hand, if $i < 0$, then recall that $(-i, j) \in \text{Inv}_{\mathbb{B}}(u)$ if and only if $(-i, j) \in \text{Inv}(u)$ if and only if $(-j, i) \in \text{Inv}(u)$, where, in the expression $\text{Inv}(u)$, u is considered as a permutation of the linear order $[\pm n]$. Moreover, since the π_x^u is symmetric along the diagonal, observe that (i, j) is below the π_x^u if and only if (j, i) is below the π_x^u . Therefore, it will be enough to observe that for $y < 0$ and $x > 0$, (x, y) is below π_x^u if and only if x appears before y in u , as suggested in the picture on the right. \square

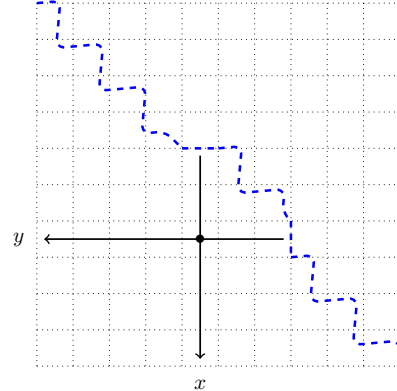

We introduce next a second representation of signed permutations.

Definition 3.5. A simply barred permutation of $[n]$ is a pair (w, B) where $w \in S_n$ and $B \subseteq \{1, \dots, n\}$. We let SBP_n be the set of simply barred permutations of $[n]$.

We think of B as a set of positions of w , the barred positions. We have added the adjective “simply” to “barred permutation” since we do not require that B is a superset of $\text{Des}(w)$, as for example in [10].

Example 3.6. Consider (w, B) with $w = 7423165$ and $B = \{2, 4, 6\}$. We represent (w, B) as a permutation divided into blocks by the bars, placing a vertical bar after u_i for each $i \in B$, e.g. $74|23|16|5$. Notice that we allow a bar to appear in the last position, for example $34|1|265|7$ stands for the simply barred permutation $(3412657, \{2, 3, 6, 7\})$. Thus, a bar appears in the last position if and only if the last block is empty. \diamond

We describe next a bijection—that we call ψ —from the set SBP_n to \mathbb{B}_n . Let us notice that, in order to establish equipotence of these two sets, other bijections are available and more straightforward.

Definition 3.7. For $(w, B) \in \text{SBP}_n$, we define the signed permutation $\psi(w, B) \in \mathbb{B}_n$ according to the following algorithm: (i) draw the grid $[n]_0 \times [n]_0$; (ii) since $B \subseteq [n]$, $B \times B$ defines a subgrid of $[n]_0 \times [n]_0$, construct the upper anti-diagonal π of this subgrid; (iii) $\psi(w, B)$ is the signed permutation u whose path representation $(\pi^u, \lambda_x^u, \lambda_y^u)$ equals (π, w, \bar{w}) .

Example 3.8. The required construction can be understood as raising the bars and transforming them into a grid. For example, for the simply barred permutation $74|2|316|5$ (that is (w, B) with $w = 7423165$ and $B = \{2, 3, 6\}$) the construction is as follows:

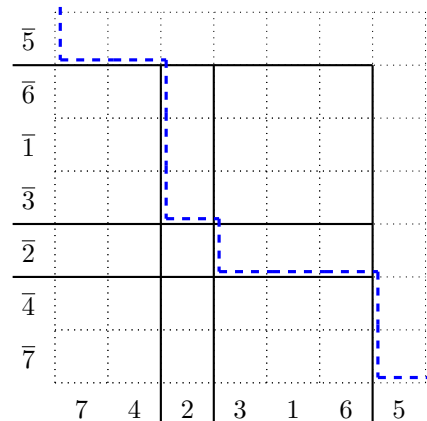

The dashed path is the anti-diagonal of the subgrid. The resulting signed permutation $\psi(w, B)$ is $\bar{2}316\bar{4}\bar{7}5$ as from Example 3.2. \diamond

Notice that the inverse image of ψ has a possibly easier description, as it can be constructed according to the following algorithm: for $u \in \mathbb{B}_n$ (i) construct the path representation $(\pi^u, \lambda_x^u, \lambda_y^u)$ of u , (ii) insert a bar in w at each vertical step

of π^u (and remove consecutive bars), (iii) remove a bar at position 0 if it exists. Said otherwise, $(w, B) = \psi^{-1}(u)$ is obtained from u by transforming each negative letter into a bar, by removing consecutive bars, and then by removing a bar at position 0 if needed.

In the following chapter we shall deal mostly with simply barred permutations. Even if we understand simply barred permutations just as shorthands for path representations of even signed permutations, some remarks are due:

Lemma 3.9. *If $u = \psi(w, B)$, then there is a bijection between the set B of bars and the set of xy -turns of π^u .*

4 Descents from simply barred permutations

We start investigating how the type B descent set can be recovered from a simply barred permutation.

Proposition 4.1. *For a simply barred permutation (w, B) , we have*

$$\text{des}_B(\psi(w, B)) = |\text{Des}(w) \setminus B| + \left\lceil \frac{|B|}{2} \right\rceil. \quad (7)$$

Proof. Write $u = \psi(w, B)$ in window notation and divide it in maximal blocks of consecutive letters having the same sign. If the first block has negative sign, add a zero positive block which is empty. Each change of sign $+-$ among consecutive blocks yields a descent. These changes of sign bijectively correspond to xy -turns of π^u that lie on or below the diagonal. By Lemma 3.9, each bar determines an xy -turn and, by symmetry of π^u along the diagonal, the number of xy -turns that are on or below the diagonal is $\left\lceil \frac{|B|}{2} \right\rceil$. Therefore this quantity counts the number of descents determined by a change of sign.

The other descents of $\psi(w, B)$ are either of the form $w_i w_{i+1}$ with $w_i > w_{i+1}$ and w_i, w_{i+1} belonging to the same positive block, or of the form $\overline{w_{i+1} w_i}$ with $w_i > w_{i+1}$ and $\overline{w_i}, \overline{w_{i+1}}$ belonging to the same negative block. These descents are in bijection with the descent positions of w that do not belong to the set B . \square

The following lemma might be immediately proved by considering that $0 \in \text{Des}_B(u)$ if and only if, in the path representation of $\psi(w, B)$, the first step of π^u is along the y -axis. In this case (and only in this case), π^u makes an xy -turn on the diagonal. This happens exactly when π^u has an odd number of xy -turns.

Lemma 4.2. *We have $0 \in \text{Des}_B(\psi(w, B))$ if and only if $|B|$ is odd.*

For each $k \in \{0, 1, \dots, n\}$, in the following we let $\text{SBP}_{n,k}$ be the set simply barred permutations $(w, B) \in \text{SBP}_n$ such that $|\text{Des}(w) \setminus B| + \left\lceil \frac{|B|}{2} \right\rceil = k$.

Corollary 4.3. *The set $\text{SBP}_{n,k}$ is in bijection with the set of signed permutations of n with k descents.*

Definition 4.4. A *loosely barred permutation* of $[n]$ is a pair (w, B) where w is a permutation of $[n]$ and $B \subseteq \{0, \dots, n\}$ is a set of positions (the bars). We let LBP_n be the set of *loosely barred permutations* of $[n]$.

Loosely barred permutations are being introduced only as a tool to index simply barred permutations independently of the even/odd cardinalities of their set of bars. Namely, for a loosely barred permutation (w, B) , let us define its simplification $\zeta(w, B)$ by

$$\zeta(w, B) := (w, B \setminus \{0\}).$$

Then $\zeta(w, B)$ is a simply barred permutation whose set of bars has even (resp., odd) cardinality if either $0 \in B$ and $|B|$ is odd (resp., even), or $0 \notin B$ and $|B|$ is even (resp., odd). For a loosely barred permutations (w, B) , we shall often need to evaluate the expression $\left\lceil \frac{|B \setminus \{0\}|}{2} \right\rceil$. We record this value once for all in the lemma below.

Lemma 4.5. *For a loosely barred permutation (w, B) we have*

$$\left\lceil \frac{|B \setminus \{0\}|}{2} \right\rceil = \begin{cases} \frac{|B|}{2}, & \text{if } |B| \text{ is even,} \\ \frac{|B|-1}{2}, & \text{if } |B| \text{ is odd and } 0 \in B, \\ \frac{|B|+1}{2}, & \text{if } |B| \text{ is odd and } 0 \notin B. \end{cases} \quad (8)$$

Next, we define an involution—that we name θ —from the set of loosely barred permutations to itself. For a loosely barred permutation (w, B) , $\theta(w, B)$ is defined by:

$$\theta(w, B) := (w, \text{Des}(w) \Delta B), \quad (9)$$

where Δ stands for symmetric difference. Let us insist that this involution is defined for all loosely barred permutations, not just for the simply barred permutations.²

Lemma 4.6. *If $(u, C) = \theta(w, B)$, then*

$$|D(w)| + |B| = 2|D(u) \setminus C| + |C|. \quad (10)$$

Proof. Recall that $C = D(w)\Delta B$ and so $D(u) \setminus C = D(w) \cap B$. Equation (10) follows since $|D(w)| + |B| = |D(w)\Delta B| + 2|D(w) \cap B|$. \square

More formally, we define a variant Θ_n of the correspondences θ defined in (9) as follows:

$$\Theta_n(w, B) := \varsigma(\theta(w, B)) = (w, \text{Des}(w)\Delta B \setminus \{0\}).$$

Notice that, this time, $\Theta_n : \text{LBP}_n \rightarrow \text{SBP}_n$.

Definition 4.7. For each $n \geq 0$ and $k \in [2n]_0$, we let $\text{LBP}_{n,k}$ be the set of loosely barred permutations (w, B) such that $|\text{Des}(w)| + |B| = k$.

Proposition 4.8. *For each $n \geq 0$ and $k \in [n]_0$, the restriction of Θ_n to $\text{LBP}_{n,2k}$ yields a bijection $\Theta_{n,k}$ from $\text{LBP}_{n,2k}$ to $\text{SBP}_{n,k}$.*

Proof. Let $(w, B) \in \text{LBP}_{n,2k}$, so $|\text{Des}(w)| + |B| = 2k$. Let also $(u, C) = \theta(w, B)$, so $\Theta_n(w, B) = (w, C \setminus \{0\})$. Then, by (10),

$$2k = 2|D(u) \setminus C| + |C|$$

and so $|C|$ is even. Therefore

$$|D(w) \setminus (C \setminus \{0\})| + \left\lceil \frac{|C \setminus \{0\}|}{2} \right\rceil = |D(u) \setminus C| + \left\lceil \frac{|C \setminus \{0\}|}{2} \right\rceil = |D(u) \setminus C| + \frac{|C|}{2} = k,$$

where in the last step we have used equation (8).

The transformation $\Theta_{n,k}$ is injective. If $\Theta_n(w, B) = \Theta_n(w', B')$, then $w = w'$ and $\text{Des}(w) = \text{Des}(w')$. Moreover, from $\text{Des}(w)\Delta B \setminus \{0\} = \text{Des}(w)\Delta B' \setminus \{0\}$ we deduce $B \setminus \{0\} = B' \setminus \{0\}$. If moreover $(w, B), (w', B') \in \text{LBP}_{n,2k}$, then $|B| = 2k - |\text{Des}(w)| = |B'|$ and $B \setminus \{0\} = B' \setminus \{0\}$ imply that $0 \in \text{Des}(w)\Delta B$ if and only if $0 \in \text{Des}(w)\Delta B'$. It follows that $B = B'$.

In order to show that the transformation $\Theta_{n,k}$ is surjective, let us fix $(u, C) \in \text{SBP}_{n,k}$, so $|\text{Des}(u) \setminus C| + \left\lceil \frac{|C|}{2} \right\rceil = k$. If $|C|$ is even, then $(w, B) := \theta(u, C)$ is such that $\Theta_n(w, B) = \theta(w, B) = (u, C)$ and, using equations (8) and (10), $(w, B) \in \text{LBP}_{n,2k}$:

$$|\text{Des}(w)| + |B| = 2|\text{Des}(u) \setminus C| + |C| = 2\left(|\text{Des}(u) \setminus C| + \left\lceil \frac{|C|}{2} \right\rceil\right) = 2k.$$

If $|C|$ is odd, then $(w, B) := \theta(u, C \cup \{0\})$ is such that $\Theta_n(w, B) = (u, C)$ and $(w, B) \in \text{LBP}_{n,2k}$:

$$\begin{aligned} |\text{Des}(w)| + |B| &= 2|\text{Des}(u) \setminus (C \cup \{0\})| + |C \cup \{0\}| = 2|\text{Des}(u) \setminus C| + 2\frac{|C|+1}{2} \\ &= 2\left(|\text{Des}(u) \setminus C| + \left\lceil \frac{|C|}{2} \right\rceil\right) = 2k. \end{aligned} \quad \square$$

Definition 4.9. For each $k \in [n-1]_0$, we let SBP_n^k be the set of simply barred permutations $(w, B) \in \text{SBP}_n$ such that $|\text{Des}_B^+(\psi(w, B))| = k$.

Notice that

$$|\text{Des}_B^+(\psi(w, B))| = k \quad \text{iff} \quad \begin{cases} 0 \notin \text{Des}_B(\psi(w, B)) \text{ and } \text{des}_B(\psi(w, B)) = k, \text{ or} \\ 0 \in \text{Des}_B(\psi(w, B)) \text{ and } \text{des}_B(\psi(w, B)) = k + 1. \end{cases}$$

Using Lemma 4.2 and equation (7), for $(w, B) \in \text{SBP}_n$ we have

$$(w, B) \in \text{SBP}_n^k \quad \text{iff} \quad \begin{cases} |B| \text{ is even and } |D(w) \setminus B| + \left\lceil \frac{|B|}{2} \right\rceil = k, \text{ or} \\ |B| \text{ is odd and } |D(w) \setminus B| + \left\lceil \frac{|B|}{2} \right\rceil = k + 1. \end{cases}$$

²At the moment of writing we cannot pinpoint any other usage of this involution apart, of course, from yielding our bijections and counting results.

Proposition 4.10. For each $k \in [n-1]_0$, the restriction of Θ_n to $\text{LBP}_{n,2k+1}$ yields a bijection Θ_n^k from $\text{LBP}_{n,2k+1}$ to SBP_n^k .

Proof. Let $(w, B) \in \text{LBP}_{n,2k+1}$ and $(u, C) = \theta(w, B)$, so $\Theta_n(w, B) = (u, C \setminus \{0\})$. Thus $|\text{Des}(w)| + |B| = 2k+1$ and, by (10),

$$2k = 2|D(u) \setminus C| + |C| - 1,$$

so in particular $|C|$ is odd. Using equation (8), we obtain

$$|D(u) \setminus C| + \left\lceil \frac{|C \setminus \{0\}|}{2} \right\rceil = \begin{cases} |D(u) \setminus C| + \frac{|C|-1}{2} = k, & 0 \in C, \\ |D(u) \setminus C| + \frac{|C|+1}{2} = k+1, & 0 \notin C. \end{cases}$$

Considering that $|C|$ is odd, we have

$$|D(u) \setminus (C \setminus \{0\})| + \left\lceil \frac{|C \setminus \{0\}|}{2} \right\rceil = \begin{cases} k, & |C \setminus \{0\}| \text{ is even,} \\ k+1, & |C \setminus \{0\}| \text{ is odd,} \end{cases}$$

that is, $(u, C \setminus \{0\}) = \Theta_n(w, B) \in \text{SBP}_n^k$.

The transformation Θ_n^k is injective, the reason being similar to the one for $\Theta_{n,k}$. If $\Theta_n(w, B) = \Theta_n(w', B')$ then $w = w'$ and $\text{Des}(w) = \text{Des}(w')$. Moreover, from $\text{Des}(w)\Delta B \setminus \{0\} = \text{Des}(w)\Delta B' \setminus \{0\}$ we deduce $B \setminus \{0\} = B' \setminus \{0\}$. Considering now that $|B| = 2k+1 - |\text{Des}(w)| = |B'|$ and $B \setminus \{0\} = B' \setminus \{0\}$, we derive $0 \in \text{Des}(w)\Delta B$ if and only if $0 \in \text{Des}(w)\Delta B'$, whence $B = B'$.

In order to show that the transformation Θ_n^k is surjective, let us fix $(u, C) \in \text{SBP}_n^k$, so either (i) $|C|$ is even and $|D(u) \setminus C| + \left\lceil \frac{|C|}{2} \right\rceil = k$ or (ii) $|C|$ is odd and $|D(u) \setminus C| + \left\lceil \frac{|C|}{2} \right\rceil = k+1$.

Let us suppose (i). Then $(w, B) := \theta(u, C \cup \{0\})$ is such that $\Theta_n(w, B) = (u, C)$ and, using equations (8) and (10), $(w, B) \in \text{LBP}_{n,2k+1}$:

$$\begin{aligned} |\text{Des}(w)| + |B| &= 2|\text{Des}(u) \setminus C| + |C \cup \{0\}| = 2|\text{Des}(u) \setminus C| + 2\frac{|C|+1}{2} \\ &= 2(|\text{Des}(u) \setminus C| + \left\lceil \frac{|C|}{2} \right\rceil + \frac{1}{2}) = 2k+1. \end{aligned}$$

Let us suppose (ii). Then $(w, B) := \theta(u, C)$ is such that $\Theta_n(w, B) = \theta(w, B) = (u, C)$ and, using equations (8) and (10), $(w, B) \in \text{LBP}_{n,2k+1}$:

$$\begin{aligned} |\text{Des}(w)| + |B| &= 2|\text{Des}(u) \setminus C| + |C| = 2|\text{Des}(u) \setminus C| + 2\frac{|C|}{2} \\ &= 2(|\text{Des}(u) \setminus C| + \left\lceil \frac{|C|}{2} \right\rceil - \frac{1}{2}) = 2(k+1) - 1 = 2k+1. \quad \square \end{aligned}$$

To end this section, we collect the consequences of the bijections established so far.

Theorem 4.11. The following relations hold:

$$\left\langle \mathbb{B}_n \right\rangle_k = \sum_{i=0}^{2k} \left\langle n \right\rangle_i \binom{n+1}{2k-i}, \quad (3)$$

$$2^n \left\langle n \right\rangle_k = \sum_{i=0}^{2k+1} \left\langle n \right\rangle_i \binom{n+1}{2k+1-i}. \quad (4)$$

Proof. We have seen that signed permutations $u \in \mathbb{B}_n$ such that $\text{des}_{\mathbb{B}}(u) = k$ are in bijection (via the mapping ψ of Definition 3.7) with simply barred permutations in $\text{SBP}_{n,k}$. Next, this set is in bijection (see Proposition (4.8)) with the set $\text{LBP}_{n,2k}$ of loosely barred permutations $(w, B) \in \text{LBP}_n$ such that $\text{des}(w) + |B| = 2k$. The cardinality of $\text{LBP}_{n,2k}$ is the right-hand side of equality (3).

The left-hand side of equality (4) is the cardinality of the set of signed permutations u such that $|\text{Des}_{\mathbb{B}}^+(u)| = k$, see Lemma 2.1. This set is in bijection with the set SBP_n^k (via ψ defined in 3.7 and by the definition of SBP_n^k) which, in turn, is in bijection (see Proposition (4.10)) with the set $\text{LBP}_{n,2k+1}$ of loosely barred permutations $(w, B) \in \text{LBP}_n$ such that $\text{des}(w) + |B| = 2k+1$. The cardinality of this set is the right-hand side of equality (4). \square

Theorem 4.12. *The following relation holds:*

$$B_n(t^2) = (1+t)^{n+1}S_n(t) - 2^n t S_n(t^2). \quad (11)$$

Proof. By (3), $\langle \mathbb{B}_n \rangle_k$, which is the coefficient of t^{2k} in the polynomial $B_n(t^2)$, is also the coefficient of t^{2k} in $(1+t)^{n+1}S_n(t)$. By (4), $2^n \langle \mathbb{B}_n \rangle_k$ is the coefficient of t^{2k+1} in the polynomials $2^n t S_n(t^2)$ and $(1+t)^{n+1}S_n(t)$. Therefore

$$B_n(t^2) + 2^n t S_n(t^2) = (1+t)^{n+1}S_n(t), \quad (5)$$

whence equation (11). \square

5 Stembridge's identity for Eulerian numbers in type D

Let us recall that a signed permutation $u \in \mathbb{B}_n$ is *even signed* if the number of negative letters in its window notation is even. The even signed permutations of \mathbb{B}_n form a subgroup D_n of \mathbb{B}_n and in fact the groups D_n are the standard models for abstract Coxeter groups of type D.

Definitions analogous to those given in Section 2 for the types A and B can be given for type D. Namely, for $u \in D_n$, we set

$$\text{Des}_D(u) := \{i \in \{0, 1, \dots, n-1\} \mid u_i > u_{i+1}\}, \quad (12)$$

where we have set $u_0 = -u_2$,

$$\text{des}_D(u) := |\text{Des}_D(u)|, \quad \left\langle \begin{matrix} D_n \\ k \end{matrix} \right\rangle := |\{u \in D_n \mid \text{des}_D(u) = k\}|, \quad D_n(t) := \sum_{k=0}^n \left\langle \begin{matrix} D_n \\ k \end{matrix} \right\rangle t^k.$$

The formula in (12) is the standard one, see e.g. [4, §8.2] or [1]. The reader will have no difficulties verifying that, up to renaming 0 by -1 , the type D descent set of u can also be defined using the following, see [14, §13]:

$$\text{Des}_D(u) := \{i \in \{-1, 1, \dots, n-1\} \mid u_i > u_{|i|+1}\}. \quad (13)$$

It is convenient to consider a more flexible representation of elements of D_n . If $u \in \mathbb{B}_n$, then its mate is the signed permutation $\underline{u} \in \mathbb{B}_n$ that differs from u only for the sign of the first letter. Notice that $\underline{\underline{u}} = u$. We define a *forked signed permutation* (see [14, §13]) as an unordered pair of the form $\{u, \underline{u}\}$ for some $u \in \mathbb{B}_n$. Clearly, just one of the mates is even signed and therefore forked signed permutations are combinatorial models of D_n .

The path representation of a forked signed permutation is insensitive of how the diagonal is crossed, either from the West, or from the North. The following are possible ways to draw a forked signed permutation on a grid:

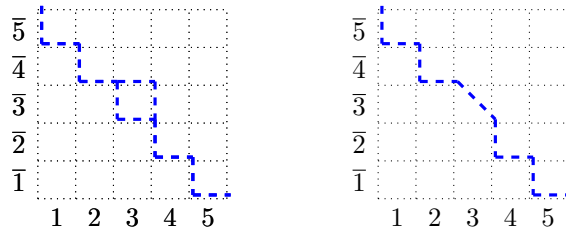

Even if the formulas in (12) and (13) have been defined for even signed permutations, they still can be computed for all signed permutations. The formula in (13) is not invariant under taking mates, however the following lemma shows that this formula suffices to compute the number of type D descents of a forked signed permutation and therefore the Eulerian numbers $\langle \begin{matrix} D_n \\ k \end{matrix} \rangle$.

Lemma 5.1. *For each $u \in \mathbb{B}_n$, $1 \in \text{Des}_D(u)$ if and only if $-1 \in \text{Des}_D(u)$. Therefore $\text{des}_D(u) = \text{des}_D(\underline{u})$.*

Proof. Suppose $1 \in \text{Des}_D(u)$, that is $u_1 > u_2$. Then $\underline{u}_{-1} = -(-u_1) = u_1 > u_2$, and so $-1 \in \text{Des}_D(u)$. The opposite implication is proved similarly.

For the last statement, observe that $\text{Des}_D(u) = \Delta_u \cup \{i \in \{2, \dots, n-1\} \mid u_i > u_{i+1}\}$ with $\Delta_u := \{i \in \{1, -1\} \mid u_i > u_{|i|+1}\}$ and, by what we have just remarked, we have $|\Delta_u| = |\Delta_{\underline{u}}|$. It follows that $|\text{Des}_D(u)| = |\text{Des}_D(\underline{u})|$. \square

Our next aim is to derive Stembridge's identity

$$D_n(t) = B_n(t) - n2^{n-1}tS_{n-1}(t), \quad (14)$$

see [22, Lemma 9.1], which, in term of the coefficients of these polynomials, amounts to

$$\left\langle \begin{matrix} D_n \\ k \end{matrix} \right\rangle = \left\langle \begin{matrix} B_n \\ k \end{matrix} \right\rangle - n2^{n-1} \left\langle \begin{matrix} n-1 \\ k-1 \end{matrix} \right\rangle. \quad (15)$$

Definition 5.2. A signed permutation u is *smooth* if u_1, u_2 have equal sign and, otherwise, it is non-smooth.

The reason for naming a signed permutation smooth arises again from the path representation of a signed permutation: the smooth signed permutation is, between the two mates, the one that minimizes the turns nearby the diagonal, as suggested below with two pairs of mates as examples:

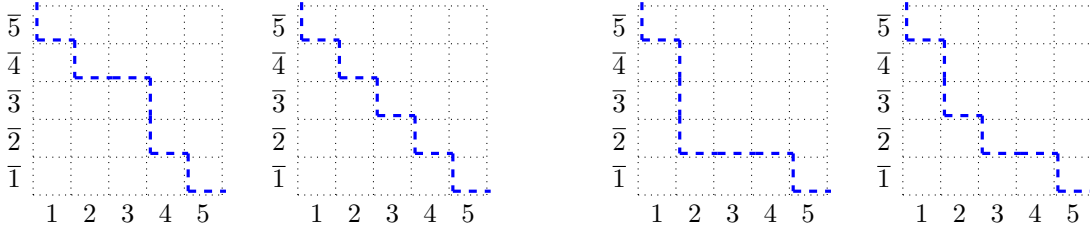

Lemma 5.3. *If $u \in B_n$ is smooth, then $-1 \in \text{Des}_D(u)$ if and only if $0 \in \text{Des}_B(u)$ and therefore $\text{des}_D(u) = \text{des}_B(u)$.*

Proof. Suppose $0 \in \text{Des}_B(u)$, so $u_1 < 0$ and $u_2 < 0$ as well, since u is smooth. Then $u_{-1} = -u_1 > 0 > u_2$, so $-1 \in \text{Des}_D(u)$. Conversely, suppose $-1 \in \text{Des}_D(u)$, that is, $u_{-1} > u_2$. If $u_1 > 0$, then $0 > -u_1 = u_{-1} > u_2$, so u_1, u_2 have different sign, a contradiction. Therefore $u_1 < 0$ and $0 \in \text{Des}_B(u)$. \square

Next, we consider the correspondence—let us call it χ —sending a non-smooth signed permutation $u \in B_n$ to the pair $(|u_1|, u')$, where u' is obtained from $u_2 \dots u_n$ by normalising this sequence, so that it takes absolute values in the set $[n-1]$. For example $\chi(6\overline{1}23475) = (6, \overline{1}23465)$ and $\chi(2\overline{3}16475) = (2, 215364)$, as suggested below:

$$6\overline{1}23475 \rightsquigarrow (6, \overline{1}23475) \rightsquigarrow (6, \overline{1}23465), \quad 2\overline{3}16475 \rightsquigarrow (2, 316475) \rightsquigarrow (2, 215364).$$

The process of normalizing the sequence $u_2 \dots u_n$ can be understood as applying to each letter of this sequence the unique order preserving bijection $N_{n,x} : [\pm n] \setminus \{x, \bar{x}\} \rightarrow [\pm n-1]$ where, in general, $x \in [n]$ and, in this case, $x = |u_1|$.

Lemma 5.4. *Let $n \geq 2$. For each pair (x, v) with $x \in [n]$ and $v \in B_{n-1}$, there exists a unique non-smooth $u \in B_n$ such that $\chi(u) = (x, v)$.*

Proof. We construct u firstly by renaming v to v' so that none of x, \bar{x} appears in v' (that is, we apply to each letter of v the inverse of $N_{n,x}$) and then by adding in front of v' either x or \bar{x} , according to the sign of the first letter of v' . \square

Lemma 5.5. *The correspondence χ restricts to a bijection from the set of non-smooth signed permutations $u \in B_n$ such that $\text{des}_B(u) = k$ to the set of pairs (x, v) where $x \in [n]$ and $v \in B_{n-1}$ is such that $|\text{Des}_B^+(v)| = k-1$.*

Proof. We have already argued that χ is a bijection from the set of non-smooth signed permutations u of $[n]$ to the set of pairs (x, v) with $x \in [n]$ and $v \in B_{n-1}$. Therefore, we are left to argue that, for non-smooth u and v , if $\text{des}_B(u) = k$, then $|\text{Des}_B^+(v)| = k-1$. Since u_1, u_2 have different sign, then $|\text{Des}_B(u) \cap \{0, 1\}| = 1$. Clearly, if $\chi(u) = (x, v)$, then $\text{Des}_B^+(v) = \{i-1 \mid i \in \text{Des}_B(u) \cap \{2, \dots, n-1\}\}$, from which the statement of the lemma follows. \square

Theorem 5.6. *The following relations hold:*

$$\left\langle \begin{matrix} B_n \\ k \end{matrix} \right\rangle = \left\langle \begin{matrix} D_n \\ k \end{matrix} \right\rangle + n2^{n-1} \left\langle \begin{matrix} n-1 \\ k-1 \end{matrix} \right\rangle, \quad B_n(t) = D_n(t) + n2^{n-1}tS_{n-1}(t).$$

Proof. Every signed permutation is either smooth or non-smooth. By Lemma 5.3, the smooth signed permutations with k type B descents are in bijection with the even signed permutations with k type D descents. By Lemma 5.5, the non-smooth signed permutations $u \in B_n$ with k type B descents are in bijection with the pairs $(x, v) \in [n] \times B_{n-1}$ such $|\text{Des}_B^+(v)| = k-1$. Using Lemma 2.1, the number of these pairs is $n2^{n-1} \left\langle \begin{matrix} n-1 \\ k-1 \end{matrix} \right\rangle$. \square

Example 5.7. We end this section exemplifying the use of formulas (3) and (15) by which computation of the Eulerian numbers in type B and D is reduced to computing Eulerian numbers in type A. Let us mention that our interest in Eulerian numbers originates from our lattice theoretic work on the lattice variety of Permutohedra [19] and its possible extensions to generalized forms of Permutohedra [15, 18, 17]. Among these generalizations, we count lattices of finite Coxeter groups in the types B and D [3]. While it is known that the lattices B_n span the same lattice variety of the permutohedra, see [6, Exercice 1.23], characterising the lattice variety spanned by the lattices D_n is an open problem. A first step towards solving this kind of problem is to characterize (and count) the join-irreducible elements of a class of lattices. In our case, this amounts to characterizing the elements u in B_n (resp., in D_n) such that $\text{des}_B(u) = 1$ (resp., such that $\text{des}_D(u) = 1$). The numbers $\langle B_n \rangle_1$ and $\langle D_n \rangle_1$ are known to be equal to $3^n - n - 1$ and $3^n - n - 1 - n2^{n-1}$ respectively, see [14, Propositions 13.3 and 13.4]. Let us see how to derive these identities using the formulas (3) and (15). To this end, we also need the alternating sum formula for Eulerian numbers, see e.g. [14, page 12]:

$$\langle n \rangle_k = \sum_{j=0}^k (-1)^j \binom{n+1}{j} (k+1-j)^n. \quad (16)$$

For type B, we have

$$\begin{aligned} \langle B_n \rangle_1 &= \langle n \rangle_0 \binom{n+1}{2} + \langle n \rangle_1 \binom{n+1}{1} + \langle n \rangle_2 \binom{n+1}{0} \\ &= \binom{n+1}{2} + (2^n - n - 1)(n+1) + \langle n \rangle_2 \\ &= \binom{n+1}{2} + (2^n - n - 1)(n+1) + 3^n - 2^n(n+1) + \binom{n+1}{2}, \quad \text{by (16)} \\ &= 3^n - (n+1)^2 + 2 \binom{n+1}{2} = 3^n - (n+1)(n+1-n) = 3^n - n - 1. \end{aligned}$$

The computation in type D is then immediate from Stembridge's identity (15):

$$\langle D_n \rangle_1 = \langle B_n \rangle_1 - n2^{n-1} \langle n-1 \rangle_0 = 3^n - n - 1 - n2^{n-1}. \quad \diamond$$

6 Threshold graphs and their degree orderings

Besides presenting the bijective proofs, a goal of this paper is to exemplify the potential of the path representation of signed permutations. The attentive reader might object then that the path representation is not being used in Section 5. Indeed, after discovering this proof via this representation of signed permutations, we realized that the presentation of the proof could be simplified by avoiding mention of the path representation. It might be asked then whether the path representation yields something more, in particular with respect to the lattices of the Coxeter groups D_n . We answer. The type D set of inversions of an even signed permutation (or of a forked signed permutation) can be defined as follows:

$$\text{Inv}_D(u) := \text{Inv}_B(u) \setminus \{(-i, i) \mid i \in [n]\},$$

which, graphically, amounts to ignoring boxes on the diagonal:

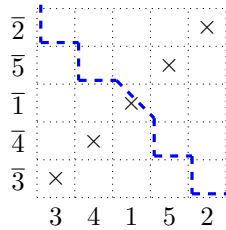

As mentioned in Proposition 3.4, we can identify the set of inversions of a signed permutation u with the disjoint union of $\text{Inv}(\lambda_x^u)$ and a set of unordered pairs. For even signed permutations, this identification yields

$$\text{Inv}_D(u) = \text{Inv}(\lambda_x^u) \cup E^u \quad \text{with} \quad E^u := \{ \{i, j\} \mid i, j \in [n], i \neq j, ((\lambda_x^u)^{-1}(i), (\lambda_x^u)^{-1}(j)) \text{ lies below } \pi^u \}.$$

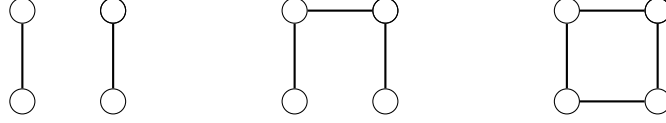

Figure 1: The (unlabelled) graphs $K_{2,2}$, P_3 , and C_4

Thus, we may consider $([n], E^u)$ as a simple graph on the set of vertices $[n]$. Let us recall the following standard definitions that apply to an arbitrary simple graph (V, E) and to a vertex $v \in V$:

$$N_E(v) := \{u \in V \mid \{v, u\} \in E\}, \quad \deg_E(v) := |N_E(v)|, \quad N_E[v] := N(v) \cup \{v\}.$$

A linear ordering v_1, \dots, v_n of V is a *degree ordering* of (V, E) if $\deg_E(v_1) \geq \deg_E(v_2) \geq \dots \geq \deg_E(v_n)$. The *vicinal preorder* of a graph (V, E) , noted \triangleleft_E , is defined by saying that $v \triangleleft_E u$ iff $N_E(v) \subseteq N_E[u]$. That the vicinal preorder is indeed a preorder is well known, see e.g. [12]. Next, we take Theorem 1 in [7] as the definition of the class of threshold graphs and consider, among the possible characterisations of this class, the one that uses the vicinal preorder.

Definition 6.1. A graph (V, E) is *threshold* if it does not contain an induced subgraph isomorphic to one among $K_{2,2}$, P_3 and C_4 (these graphs are illustrated in Figure 1).

Proposition 6.2 (see e.g. [12, Theorem 1.2.4]). *A graph (V, E) is threshold if and only if the vicinal preorder is total.*

With these tools available, let us observe the following:

Theorem 6.3. *The mapping sending u to (λ_x^u, E^u) is a bijection from the set D_n to the set of pairs (w, E) such that $([n], E)$ is a threshold graph and $w \in S_n$ is a degree ordering on this graph.*

Proof. We start arguing that, for $u \in D_n$, $([n], E^u)$ is a threshold graph and that λ_x^u is a degree ordering on this graph. Notice that $E^u = E^{\bar{u}}$, so we can suppose that u is the mate such that $u_1 > 0$. Clearly, we can also suppose that λ_x^u is the identity permutation. Under these hypothesis, the paths π^u that are symmetric along the diagonal bijectively correspond to fixed-point free self-adjoint Galois connections, see e.g. [16] for the general correspondence between paths and sup-preserving functions. For a fixed-point free self-adjoint Galois connection we mean an antitone map $f : [n]_0 \rightarrow [n]_0$ such that, for each $x, y \in [n]_0$, $x \leq f(y)$ iff $y \leq f(x)$ and $x \neq f(x)$. Moreover, under these hypothesis, we have that $\{x, z\} \in E^u$ if and only if $z \neq x$ and $z \leq f(x)$, where f bijectively corresponds to π^u . Then, if $y < x$ and $z \in N_{E^u}(x)$, then $z \leq f(x) \leq f(y)$ and so either $z = y$ or $z \in N_{E^u}(y)$. We have argued that $x < y$ implies that $N_{E^u}(y) \subseteq N_{E^u}(x)$ which, in particular, implies that the identity permutation is a degree ordering on E^u and that the vicinal preorder is total, so $([n], E^u)$ is a threshold graph.

The mapping sending u to (λ_x^u, E^u) is clearly injective, so we are left to argue that every pair (w, E) , with $([n], E)$ a threshold graph and $w \in S_n$ a degree ordering on it, arises in this way. Again, we can assume that w is the identity permutation, so we need to find a fixed-point free self-adjoint Galois connection $f : [n]_0 \rightarrow [n]_0$ such that, for $x, z \in [n]$, $\{x, z\} \in E$ if and only if $x \neq z$ and $z \leq f(x)$.

Observe that if $\deg_E(y) \leq \deg_E(x)$, then necessarily we have $N_E(y) \subseteq N_E[x]$, otherwise $N_E(x) \subseteq N_E[y]$ and we get a contradiction. Thus, if $x < y$, then $N_E(y) \subseteq N_E[x]$, since the identity permutation is a degree ordering. Define then $f(x) = \max N_E(x)$, with the conventions that $\max \emptyset = 0$ and $N_E(0) = [n]_0$. For $x, z \in [n]$, if $\{x, z\} \in E$, then $z \in N_E(x)$ and then $z \leq f(x)$. Conversely, if $z \leq f(x)$, then $x \in N_E(f(x)) \subseteq N_E[z]$, so if $x \neq z$, then $x \in N_E(z)$ and $\{x, z\} \in E$. Finally f is a fixed-point free self-adjoint Galois connection: it is fixed-point free since $x \notin N_E(x)$, and it is easily seen that $y \leq f(x)$ if and only if $x \leq f(y)$, for each $x, y \in [n]_0$, property that also implies that f is antitone. \square

Let us remark that Theorem 6.3 also yields a natural representation of the weak ordering on D_n as follows: under the bijection, $(w_1, E_1) \leq (w_2, E_2)$ holds if and only if $w_1 \leq w_2$ in the weak ordering of S_n and, moreover, $E_1 \subseteq E_2$. This poset (actually a lattice, since it is isomorphic to D_n) is built out from threshold graphs but is only loosely related to the lattice of threshold graphs of [13] where unlabeled (that is, up to isomorphism) threshold graphs are considered.

That threshold graphs are related to the families B and D in the theory of Coxeter groups has already been observed, see e.g. [8], [20, Exercise 5.25], and [21, Exercise 3.115]. As part of possible future research, it is tempting to investigate further the bijection presented in Theorem 6.3 (which can be further adapted to fit the type B) and try to understand if it plays any important role with respect to the problem, partly solved in [8], of characterizing free sub-arrangements of the Coxeter arrangements B_n .

References

- [1] E. Bagno, R. Biagioli, and D. Garber. Stirling and eulerian numbers of types B and D . In L. Ferrari and M. Vamvakari, editors, *Proceedings of the 11th International Conference on Random and Exhaustive Generation of Combinatorial Structures, GASCom 2018, Athens, Greece, June 18-20, 2018*, volume 2113 of *CEUR Workshop Proceedings*, pages 53–59. CEUR-WS.org, 2018.
- [2] E. Barnard. The canonical join complex. Preprint, retrievable from <https://arxiv.org/abs/1610.05137>, 2016.
- [3] A. Björner. Orderings of Coxeter groups. In *Combinatorics and Algebra (Boulder, Colo., 1983)*, volume 34 of *Contemp. Math.*, pages 175–195. Amer. Math. Soc., Providence, RI, 1984.
- [4] A. Björner and F. Brenti. *Combinatorics of Coxeter groups*, volume 231 of *Graduate Texts in Mathematics*. Springer, New York, 2005.
- [5] M. Bóna. *Combinatorics of permutations*. Discrete Mathematics and its Applications (Boca Raton). CRC Press, Boca Raton, FL, second edition, 2012. With a foreword by Richard Stanley.
- [6] N. Caspard, L. Santocanale, and F. Wehrung. Permutohedra and associahedra. In *Lattice theory: special topics and applications. Vol. 2*, pages 215–286. Birkhäuser/Springer, Cham, 2016.
- [7] V. Chvátal and P. L. Hammer. Aggregation of inequalities in integer programming. In *Studies in integer programming (Proc. Workshop, Bonn, 1975)*, pages 145–162. Ann. of Discrete Math., Vol. 1, 1977.
- [8] P. H. Edelman and V. Reiner. Free hyperplane arrangements between A_{n-1} and B_n . *Math. Z.*, 215(3):347–365, 1994.
- [9] R. Freese, J. Ježek, and J. Nation. *Free Lattices*, volume 42 of *Mathematical Surveys and Monographs*. American Mathematical Society, Providence, RI, 1995.
- [10] I. Gessel and R. P. Stanley. Stirling polynomials. *J. Combinatorial Theory Ser. A*, 24(1):24–33, 1978.
- [11] G. Guilbaud and P. Rosenstiehl. Analyse algébrique d’un scrutin. *Math. Sci. Hum.*, 4:9–33, 1963.
- [12] N. V. R. Mahadev and U. N. Peled. *Threshold graphs and related topics*, volume 56 of *Annals of Discrete Mathematics*. North-Holland Publishing Co., Amsterdam, 1995.
- [13] R. Merris and T. Roby. The lattice of threshold graphs. *JIPAM. J. Inequal. Pure Appl. Math.*, 6(1):Article 2, 21, 2005.
- [14] T. K. Petersen. *Eulerian numbers*. Birkhäuser Advanced Texts: Basler Lehrbücher. [Birkhäuser Advanced Texts: Basel Textbooks]. Birkhäuser/Springer, New York, 2015. With a foreword by Richard Stanley.
- [15] M. Pouzet, K. Reuter, I. Rival, and N. Zaguia. A generalized permutahedron. *Algebra Universalis*, 34(4):496–509, 1995.
- [16] L. Santocanale. On discrete idempotent paths. In R. Mercaş and D. Reidenbach, editors, *WORDS 2019*, volume 11682 of *Lecture Notes in Comput. Sci.*, pages 312–325. Springer, Cham, 2019.
- [17] L. Santocanale and M. J. Gouveia. The continuous weak order. *Journal of Pure and Applied Algebra*, 2020. In press.
- [18] L. Santocanale and F. Wehrung. Generalizations of the permutahedron. In *Lattice Theory: Special Topics and Applications. Vol. 2*, pages 287–397. Birkhäuser, 2016.
- [19] L. Santocanale and F. Wehrung. The equational theory of the weak Bruhat order on finite symmetric groups. *Journal of the European Mathematical Society*, 20(8):1959–2003, 2018.
- [20] R. P. Stanley. An introduction to hyperplane arrangements. In *Geometric combinatorics*, volume 13 of *IAS/Park City Math. Ser.*, pages 389–496. Amer. Math. Soc., Providence, RI, 2007.
- [21] R. P. Stanley. *Enumerative combinatorics. Volume 1*, volume 49 of *Cambridge Studies in Advanced Mathematics*. Cambridge University Press, Cambridge, second edition, 2012.
- [22] J. R. Stembridge. Some permutation representations of Weyl groups associated with the cohomology of toric varieties. *Adv. Math.*, 106(2):244–301, 1994.

POLYMORPHISM-HOMOGENEITY AND UNIVERSAL ALGEBRAIC GEOMETRY

Endre Tóth
Bolyai Institute
University of Szeged
Aradi vértanúk tere 1
H-6720 Szeged, Hungary
tothendre@math.u-szeged.hu

Tamás Waldhauser
Bolyai Institute
University of Szeged
Aradi vértanúk tere 1
H-6720 Szeged, Hungary
twaldha@math.u-szeged.hu

Dedicated to Maurice Pouzet on the occasion of his 75th birthday.

ABSTRACT

We assign a relational structure to any finite algebra in a canonical way, using solution sets of equations, and we prove that this relational structure is polymorphism-homogeneous if and only if the algebra itself is polymorphism-homogeneous. We show that polymorphism-homogeneity is also equivalent to the property that algebraic sets (i.e., solution sets of systems of equations) are exactly those sets of tuples that are closed under the centralizer clone of the algebra. Furthermore, we prove that the aforementioned properties hold if and only if the algebra is injective in the category of its finite subpowers. We also consider two additional conditions: a stronger variant for polymorphism-homogeneity and for injectivity, and we describe explicitly the finite semilattices, lattices, Abelian groups and monounary algebras satisfying any one of these three conditions.

Keywords Polymorphism-homogeneity · Algebraic set · Universal algebraic geometry · Solution set of a system of equations · Injective algebra

1 Introduction

Various notions of homogeneity appear in several areas of mathematics, such as model theory, group theory, combinatorics, etc. Roughly speaking, a structure \mathcal{A} is said to be homogeneous if certain kinds of local morphisms (i.e., morphisms defined on “small” substructures of \mathcal{A}) extend to endomorphisms of \mathcal{A} . Specifying the kind of morphisms that are expected to be extendible, one can define many different versions of homogeneity. We consider a variant called polymorphism-homogeneity introduced by C. Pech and M. Pech [1] that involves “multivariable” homomorphisms: we require extendibility of homomorphisms defined on finitely generated substructures of direct powers of \mathcal{A} (see Section 2.4 for the precise definition).

We study polymorphism-homogeneity of finite algebraic structures and of certain relational structures constructed from algebras. Since homomorphisms depend on the term operations, not on the particular choice of basic operations, we work mainly with the clone $C = \text{Clo}(\mathbb{A})$ of term operations of the algebraic structure $\mathbb{A} = (A, F)$ (i.e., C is the clone generated by F ; see Section 2.1). An n -ary operation $f: A^n \rightarrow A$ can be regarded as an $(n+1)$ -ary relation, called the graph of f , denoted by f^\bullet (see Section 2.3). Probably the most natural way to convert \mathbb{A} into a relational structure is to consider the graphs of the operations of \mathbb{A} , thus we define $C^\bullet = \{f^\bullet : f \in C\}$ to be the set of graphs of term operations of \mathbb{A} . We will prove that if the relational structure (A, C^\bullet) is polymorphism-homogeneous, then the algebra \mathbb{A} is also polymorphism-homogeneous, but the converse is not true in general.

To construct a relational structure that is equivalent to \mathbb{A} in terms of polymorphism-homogeneity, observe that the relation f^\bullet is nothing else than the solution set of the equation $f(x_1, \dots, x_n) = x_{n+1}$. We might consider more

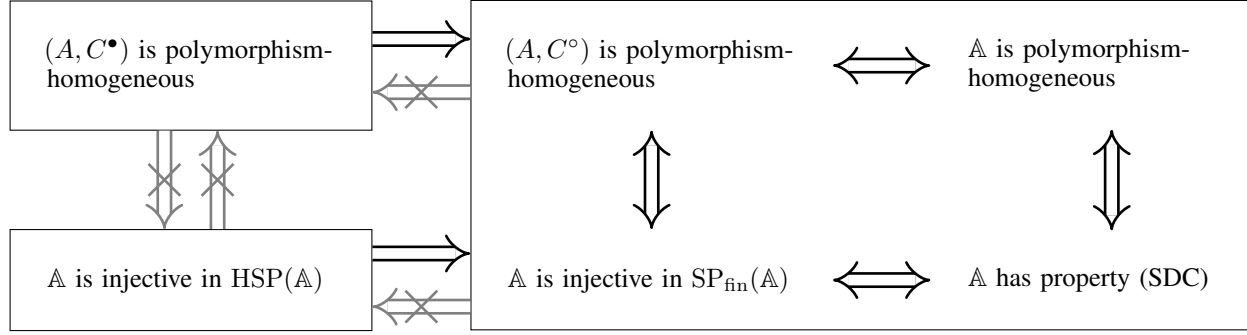

Figure 1: Relationships between property (SDC) and several variants of polymorphism-homogeneity and injectivity.

general equations where the right hand side is not necessarily a single variable: let C° be the set of solution sets of equations of the form $f(x_1, \dots, x_n) = g(x_1, \dots, x_n)$, where $f, g \in C$. It turns out that (A, C°) is the “right” choice for a relational counterpart of \mathbb{A} : the algebra \mathbb{A} is polymorphism-homogeneous if and only if the relational structure (A, C°) is polymorphism-homogeneous.

The elements of C° are solution sets of single equations, hence intersections of such sets are solution sets of systems of equations. The latter are also called algebraic sets, as they are analogues of algebraic varieties¹ investigated in algebraic geometry; the study of these sets can thus be regarded as universal algebraic geometry [2]. Motivated by the fact that a set of vectors over a field is the solution set of a system of (homogeneous) linear equations if and only if it is closed under affine linear combinations (all linear combinations), we investigated the possibility of characterizing algebraic sets by means of closure conditions in [3, 4]. If algebraic sets over \mathbb{A} are exactly those sets of tuples that are closed under a suitably chosen set of operations, then we say that \mathbb{A} has property (SDC) (see Section 2.3 for an explanation). We will see that this property is equivalent to polymorphism-homogeneity of (A, C°) and of \mathbb{A} .

The categorical notion of injectivity also asks for extensions of certain homomorphisms, so it is not surprising that a finite algebra \mathbb{A} is polymorphism-homogeneous if and only if it is injective in a certain class of algebras, namely in the class of finite subpowers of \mathbb{A} (see Section 2.5 for the definitions). Perhaps it is more natural to consider injectivity in the variety $\text{HSP } \mathbb{A}$ generated by \mathbb{A} , hence we will also investigate the relationship between this notion and polymorphism-homogeneity.

Figure 1 shows the six properties that we are concerned with in this paper. In Section 3 we prove all the implications and equivalences indicated in the figure. It turns out that for finite algebras four of the six conditions are equivalent, thus we have actually three different properties marked by the three boxes. In Section 4 we determine finite semilattices, lattices, Abelian groups and monounary algebras possessing these three properties, and these examples will justify all of the “non-implications” in Figure 1.

2 Preliminaries

2.1 Clones and relational clones

Let $\mathcal{O}_A^{(n)}$ denote the set of all n -ary operations on a set A (i.e., maps $f: A^n \rightarrow A$), and let \mathcal{O}_A be the set of all operations of arbitrary finite arities on A . In this paper we will always assume that the set A on which we consider operations and relations is finite. A set $C \subseteq \mathcal{O}_A$ of operations is a *clone* if C is closed under composition and contains the projections $(x_1, \dots, x_n) \mapsto x_i$ for $1 \leq i \leq n$. We use the symbol $C^{(n)}$ for the n -ary part of C , i.e., $C^{(n)} = C \cap \mathcal{O}_A^{(n)}$. The clone *generated* by $F \subseteq \mathcal{O}_A$ is the least clone $\text{Clo}(F)$ containing F . This is nothing else but the clone of term operations of the algebra $\mathbb{A} = (A, F)$, hence we will also use the notation $\text{Clo}(\mathbb{A})$ for this clone.

A k -ary *partial operation* on A is a map $h: \text{dom } h \rightarrow A$, where the *domain* of h can be any set $\text{dom } h \subseteq A^k$. The set of all partial operations on A is denoted by \mathcal{P}_A , and the set of all k -ary partial operations on A is denoted by $\mathcal{P}_A^{(k)}$. A *strong partial clone* is a set of partial operations that is closed under composition, contains the projections, and contains all restrictions of its members to arbitrary subsets of their domains. Note that if $C \subseteq \mathcal{O}_A$ is a clone, then the least strong

¹Note that the word variety has a different meaning in universal algebra: a variety is an equationally definable class of algebras, or, equivalently, a class of algebras that is closed under homomorphic images, subalgebras and direct products.

partial clone $\text{Str}(C)$ containing C consists of all restrictions of elements of C , i.e., $h \in \mathcal{P}_A$ belongs to $\text{Str}(C)$ if and only if h can be extended to a total operation $\hat{h} \in C$.

An n -ary relation on A is a subset of A^n ; the set of all relations (of arbitrary arities) on A is denoted by \mathcal{R}_A . Given a set of relations $R \subseteq \mathcal{R}_A$, a *primitive positive formula* $\Phi(x_1, \dots, x_n)$ over R is an existentially quantified conjunction:

$$\Phi(x_1, \dots, x_n) = \exists y_1 \cdots \exists y_m \bigwedge_{i=1}^t \rho_i(z_1^{(i)}, \dots, z_{r_i}^{(i)}), \quad (2.1)$$

where $\rho_i \in R$ is a relation of arity r_i , and each $z_j^{(i)}$ is a variable from the set $\{x_1, \dots, x_n, y_1, \dots, y_m\}$ for $i = 1, \dots, t$, $j = 1, \dots, r_i$. The relation $\rho = \{(a_1, \dots, a_n) : \Phi(a_1, \dots, a_n) \text{ is true}\} \subseteq A^n$ is then said to be *defined by the primitive positive formula* Φ . The set of all primitive positive definable relations over R is denoted by $\langle R \rangle_{\exists}$, and such sets of relations are called *relational clones*. If we allow only quantifier-free primitive positive formulas, then we obtain the *weak relational clone* $\langle R \rangle_{\#}$.

2.2 Galois connections between operations and relations

We say that a k -ary (partial) operation h *preserves* the relation $\rho \subseteq A^n$, denoted as $h \triangleright \rho$, if for every matrix $M \in A^{n \times k}$ such that each column of M belongs to ρ (and each row of M is in the domain of h), applying h to each row of M , we obtain a column that also belongs to ρ . If R is a set of relations, then we write $h \triangleright R$ to indicate that h preserves all elements of R . In other words, $h \triangleright R$ holds if and only if h is a (partial) polymorphism of the relational structure $\mathcal{A} = (A, R)$, i.e., h is a homomorphism from (the substructure $\text{dom } h$ of) \mathcal{A}^k to \mathcal{A} . The set of all (partial) operations preserving each relation of R is denoted by $\text{Pol } R$ ($\text{pPol } R$), and the set of all relations preserved by each member of a set F of (partial) operations is denoted by $\text{Inv } F$:

$$\begin{aligned} \text{Pol } R &= \{h \in \mathcal{O}_A : h \triangleright \rho \text{ for every } \rho \in R\}; \\ \text{pPol } R &= \{h \in \mathcal{P}_A : h \triangleright \rho \text{ for every } \rho \in R\}; \\ \text{Inv } F &= \{\rho \in \mathcal{R}_A : h \triangleright \rho \text{ for every } h \in F\}. \end{aligned}$$

Note that $\text{Pol } R = \text{pPol } R \cap \mathcal{O}_A$.

The closed sets under the Galois connection $\text{Pol} - \text{Inv}$ ($\text{pPol} - \text{Inv}$) between (partial) operations and relations are exactly the (strong partial) clones and the (weak) relational clones; this makes these Galois connections fundamental tools in clone theory.

Theorem 2.1 ([5, 6, 7]). *For any set of operations $F \subseteq \mathcal{O}_A$ and any set of relations $R \subseteq \mathcal{R}_A$, we have $\text{Clo}(F) = \text{Pol } \text{Inv } F$ and $\langle R \rangle_{\exists} = \text{Inv } \text{Pol } R$. For any set of partial operations $F \subseteq \mathcal{P}_A$ and any set of relations $R \subseteq \mathcal{R}_A$, we have $\text{Str}(F) = \text{pPol } \text{Inv } F$ and $\langle R \rangle_{\#} = \text{Inv } \text{pPol } R$.*

2.3 Universal algebraic geometry and centralizers

Let \mathbb{A} be a finite algebra and let $C = \text{Clo}(\mathbb{A})$. If f and g are n -ary term operations of \mathbb{A} , then $f(x_1, \dots, x_n) = g(x_1, \dots, x_n)$ is an *equation* in n variables over \mathbb{A} , which we may simply write as a pair (f, g) . The *solution set* of (f, g) is then the set $\text{Sol}(f, g) = \{(a_1, \dots, a_n) \in A^n : f(a_1, \dots, a_n) = g(a_1, \dots, a_n)\}$. Of special interest are the equations of the form $f(x_1, \dots, x_n) = x_{n+1}$; the solution set of this equation is the $(n+1)$ -ary relation $f^\bullet = \{(a_1, \dots, a_n, a_{n+1}) \in A^{n+1} : f(a_1, \dots, a_n) = a_{n+1}\}$, which is called the *graph* of f . We use the symbols C^\bullet and C° for the set of graphs and for the set of all solution sets of equations over C :

$$\begin{aligned} C^\bullet &= \{f^\bullet : f \in C\}; \\ C^\circ &= \{\text{Sol}(f, g) : f, g \in C^{(n)}, n \in \mathbb{N}\}. \end{aligned}$$

Note that $C^\bullet \subseteq C^\circ$, and it is easy to verify that $\langle C^\bullet \rangle_{\exists} = \langle C^\circ \rangle_{\exists}$ (see Lemma 3.2 of [3]), but in general $\langle C^\bullet \rangle_{\#}$ and $\langle C^\circ \rangle_{\#}$ may be different weak relational clones.

The members of $\langle C^\circ \rangle_{\#}$ are intersections of solution sets of finitely many equations, i.e., $\langle C^\circ \rangle_{\#}$ consists of solution sets of finite systems of equations over \mathbb{A} . Allowing infinite systems of equations, we obtain the so-called *algebraic sets*, which are the main objects of study in universal algebraic geometry [2]. Since we deal only with finite algebras, every system of equations is equivalent to a finite system of equations, thus the elements of $\langle C^\circ \rangle_{\#}$ are exactly the algebraic sets.

As mentioned in Section 1, basic results of linear algebra hint at the possibility that algebraic sets can sometimes be described by closure conditions. It turns out that if there is a clone D such that algebraic sets are exactly those sets of

tuples that are closed under D , then D must be the clone $C^* = \text{Pol } C^\bullet$ (see Corollary 3.7 in [3]). This clone is called the *centralizer* of C , since it consists of those operations that commute with every member of C ; in other words, a k -ary operation h belongs to C^* if and only if h is a homomorphism from \mathbb{A}^k to \mathbb{A} . (Observe that since $\langle C^\bullet \rangle_{\exists} = \langle C^\circ \rangle_{\exists}$, the centralizer can equivalently be defined as $C^* = \text{Pol } C^\circ$, by Theorem 2.1.)

If the algebraic sets (i.e., solution sets of systems of equations) of \mathbb{A} coincide with the C^* -closed sets of tuples, then we say that the algebra \mathbb{A} has property (SDC); this abbreviation stands for ‘‘Solution sets are Definable by closure under the Centralizer’’. We proved in [4] that every two-element algebra has this property, and in [3] finite semilattices and lattices with property (SDC) were characterized (see Sections 4.1 and 4.2). In general, property (SDC) is easily seen to be equivalent to the condition $\langle C^\circ \rangle_{\exists} = \langle C^\circ \rangle_{\#}$, i.e., the algebra \mathbb{A} has property (SDC) if and only if quantifiers can be eliminated from primitive positive formulas over C° (see Theorem 3.6 of [3]).

2.4 Polymorphism-homogeneity

A first-order structure \mathcal{A} (i.e., a set A equipped with relations and/or operations) is said to be *k -polymorphism-homogeneous*, if every homomorphism $h: \mathcal{B} \rightarrow \mathcal{A}$ defined on a finitely generated substructure $\mathcal{B} \leq \mathcal{A}^k$ extends to a homomorphism $\hat{h}: \mathcal{A}^k \rightarrow \mathcal{A}$. (As usual, a substructure \mathcal{B} is said to be finitely generated if there is a finite set $S \subseteq A$ such that \mathcal{B} is the smallest substructure of \mathcal{A} that contains S . Considering only finite structures, the assumption that \mathcal{B} is finitely generated can be omitted from the definition.) The case $k = 1$ gives the notion of *homomorphism-homogeneity* introduced by P. J. Cameron and J. Nešetřil [8]. If \mathcal{A} is k -polymorphism-homogeneous for every natural number k , then we say that \mathcal{A} is *polymorphism-homogeneous* [1]. These two notions are linked by the following result, which was proved for relational structures by C. Pech and M. Pech [1] and for algebraic structures by Z. Farkasová and D. Jakubíková-Studenovská [9], but the same proof works for arbitrary first-order structures.

Proposition 2.2 ([1, 9]). *A first-order structure \mathcal{A} is polymorphism-homogeneous if and only if \mathcal{A}^k is homomorphism-homogeneous for all natural numbers k .*

In the next proposition we recall a useful result from [1] that relates polymorphism-homogeneity and quantifier elimination for finite relational structures; we give a short proof utilizing the Galois connections between (partial) operations and relations.

Proposition 2.3 ([1]). *A finite relational structure has quantifier elimination for primitive positive formulas if and only if it is polymorphism-homogeneous.*

Proof. A finite relational structure $\mathcal{A} = (A, R)$ has quantifier elimination for primitive positive formulas if and only if $\langle R \rangle_{\#} = \langle R \rangle_{\exists}$. Using the Galois connections $\text{Pol} - \text{Inv}$ (clones and relational clones) and $\text{pPol} - \text{Inv}$ (strong partial clones and weak relational clones), we can reformulate this condition in several steps to reach polymorphism-homogeneity:

$$\begin{aligned}
\langle R \rangle_{\#} = \langle R \rangle_{\exists} &\iff \text{Inv pPol } R = \text{Inv Pol } R \\
&\iff \text{pPol Inv pPol } R = \text{pPol Inv Pol } R \\
&\iff \text{pPol } R = \text{Str}(\text{Pol } R) \\
&\iff \{h \in \mathcal{P}_A : h \triangleright R\} = \{h \in \mathcal{P}_A : h \text{ extends to } \hat{h} \in \mathcal{O}_A \text{ such that } \hat{h} \triangleright R\} \\
&\iff \mathcal{A} \text{ is polymorphism-homogeneous.} \quad \square
\end{aligned}$$

2.5 Injectivity

Let \mathcal{K} be a class of algebras and $\mathbb{A} \in \mathcal{K}$. We say that \mathbb{A} is *injective* in \mathcal{K} if every homomorphism $h: \mathbb{B} \rightarrow \mathbb{A}$ extends to a homomorphism $\hat{h}: \mathbb{C} \rightarrow \mathbb{A}$ whenever $\mathbb{B}, \mathbb{C} \in \mathcal{K}$ and $\mathbb{B} \leq \mathbb{C}$. Clearly, if \mathbb{A} is injective in \mathcal{K} , then \mathbb{A} is also injective in every subclass of \mathcal{K} that contains \mathbb{A} . Injectivity is most often considered in the largest relevant class \mathcal{K} ; for example, if \mathbb{A} is a group or a lattice, then \mathcal{K} is usually chosen to be the class of all groups or lattices. In this paper we shall consider smaller classes, namely the variety $\text{HSP } \mathbb{A}$ generated by \mathbb{A} and the set of finite subpowers $\text{SP}_{\text{fin}} \mathbb{A}$ of \mathbb{A} (the latter consists of all subalgebras of finite direct powers of \mathbb{A}). Let us mention that in [10] a group \mathbb{A} is called *relatively injective* if it is injective in the variety $\text{HSP } \mathbb{A}$.

3 Polymorphism-homogeneity, algebraic sets and injectivity

First let us prove the equivalences shown on the right hand side of Figure 1. The equivalence of property (SDC) and polymorphism-homogeneity of (A, C°) follows immediately from Proposition 2.3.

Proposition 3.1. *If \mathbb{A} is a finite algebra and $C = \text{Clo}(\mathbb{A})$, then \mathbb{A} has property (SDC) if and only if (A, C°) is polymorphism-homogeneous.*

Proof. By Theorem 3.6 of [3], property (SDC) of \mathbb{A} is equivalent to quantifier elimination for primitive positive formulas for the relational structure (A, C°) , and the latter is equivalent to polymorphism-homogeneity of (A, C°) by Proposition 2.3. \square

Our main result is the following theorem that establishes the connection between “algebraic” and “relational” polymorphism-homogeneity (for the proof, see the extended version of the present paper at [arXiv:2007.04405](https://arxiv.org/abs/2007.04405)).

Theorem 3.2. *If \mathbb{A} is a finite algebra and $C = \text{Clo}(\mathbb{A})$, then \mathbb{A} is polymorphism-homogeneous if and only if (A, C°) is polymorphism-homogeneous.*

To complete the proof of the equivalences in the box on the right hand side of Figure 1, we relate injectivity and polymorphism-homogeneity.

Proposition 3.3. *If \mathbb{A} is a finite algebra, then \mathbb{A} is polymorphism-homogeneous if and only if \mathbb{A} is injective in $\text{SP}_{\text{fin}}(\mathbb{A})$.*

Proof. Assume that \mathbb{A} is polymorphism-homogeneous, and let $\mathbb{B}, \mathbb{C} \in \text{SP}_{\text{fin}}(\mathbb{A})$ such that $\mathbb{B} \leq \mathbb{C}$. Then we have $\mathbb{B} \leq \mathbb{C} \leq \mathbb{A}^k$ for some $k \in \mathbb{N}$; in particular, \mathbb{B} is a subalgebra of \mathbb{A}^k . Therefore, if $h: \mathbb{B} \rightarrow \mathbb{A}$ is a homomorphism, then h extends to a homomorphism $\widehat{h}: \mathbb{A}^k \rightarrow \mathbb{A}$ by the polymorphism-homogeneity of \mathbb{A} . A restriction of \widehat{h} then gives a homomorphism from \mathbb{C} to \mathbb{A} that extends h , thereby proving the injectivity of \mathbb{A} .

Conversely, if \mathbb{A} is injective in $\text{SP}_{\text{fin}}(\mathbb{A})$ and $h \in \mathcal{P}_A^{(k)}$ is a homomorphism from a subalgebra $\text{dom } h \leq \mathbb{A}^k$ to \mathbb{A} , then the injectivity of \mathbb{A} immediately yields an extension $\widehat{h}: \mathbb{A}^k \rightarrow \mathbb{A}$ of h , thus \mathbb{A} is indeed polymorphism-homogeneous. \square

Corollary 3.4. *If \mathbb{A} is a finite algebra and $C = \text{Clo}(\mathbb{A})$, then the following conditions are equivalent:*

- (i) \mathbb{A} has property (SDC);
- (ii) \mathbb{A} is polymorphism-homogeneous;
- (iii) (A, C°) is polymorphism-homogeneous;
- (iv) \mathbb{A} is injective in $\text{SP}_{\text{fin}}(\mathbb{A})$.

Proof. Combine propositions 3.1 and 3.3 and Theorem 3.2. \square

It remains to verify the “one-way” implications in Figure 1. Since $\text{HSP}(\mathbb{A}) \supseteq \text{SP}_{\text{fin}}(\mathbb{A})$, it is trivial that if \mathbb{A} is injective in $\text{HSP}(\mathbb{A})$, then it is also injective in $\text{SP}_{\text{fin}}(\mathbb{A})$. We end this section by proving the remaining implication; in fact, we formulate it in a bit more explicit form, which will be useful in the next section.

Proposition 3.5. *If \mathbb{A} is a finite algebra and $C = \text{Clo}(\mathbb{A})$, then (A, C^\bullet) is polymorphism-homogeneous if and only if (A, C°) is polymorphism-homogeneous and $\langle C^\bullet \rangle_{\#} = \langle C^\circ \rangle_{\#}$.*

Proof. According to Proposition 2.3, we need to prove the following equivalence:

$$\langle C^\bullet \rangle_{\#} = \langle C^\bullet \rangle_{\exists} \iff \langle C^\circ \rangle_{\#} = \langle C^\circ \rangle_{\exists} \text{ and } \langle C^\bullet \rangle_{\#} = \langle C^\circ \rangle_{\#}.$$

This follows immediately from the following chain of containments (the last containment is Lemma 3.2 of [3], the others are trivial):

$$\langle C^\bullet \rangle_{\#} \subseteq \langle C^\circ \rangle_{\#} \subseteq \langle C^\circ \rangle_{\exists} = \langle C^\bullet \rangle_{\exists}. \quad \square$$

4 Examples

We describe explicitly the finite algebras satisfying the properties considered in the previous section in certain well known varieties: semilattices, lattices, Abelian groups and monounary algebras. These characterizations will provide counterexamples showing that the only valid implications among these properties are the ones shown in Figure 1.

4.1 Semilattices

If we consider finite semilattices, then it turns out that five of the six conditions of Figure 1 are equivalent, and these semilattices have already been determined in the literature.

Theorem 4.1. *If \mathbb{A} is a finite semilattice and $C = \text{Clo}(\mathbb{A})$, then the following conditions are equivalent:*

- (i) \mathbb{A} has property (SDC);
- (ii) \mathbb{A} is polymorphism-homogeneous;
- (iii) (A, C°) is polymorphism-homogeneous;
- (iv) \mathbb{A} is injective in $\text{SP}_{\text{fin}}(\mathbb{A})$;
- (v) \mathbb{A} is injective in $\text{HSP}(\mathbb{A})$;
- (vi) \mathbb{A} is the semilattice reduct of a finite distributive lattice.

Proof. We know that conditions (i)–(iv) are equivalent (see Corollary 3.4), and it was proved in Theorem 5.5 of [3] that (i) is equivalent to (vi). G. Bruns and H. Lakser [11] and, independently, A. Horn and N. Kimura [12] showed that the injective objects in the category of semilattices are the semilattice reducts of completely distributive lattices. Therefore, if \mathbb{A} is the semilattice reduct of a finite distributive lattice, then \mathbb{A} is injective in the variety of all semilattices, thus \mathbb{A} is also injective in $\text{HSP}(\mathbb{A})$. This proves that (vi) implies (v), and taking into account that (v) obviously implies (iv), the proof is complete. \square

The top left condition of Figure 1 is not equivalent to the others; in fact, there is no nontrivial finite semilattice for which (A, C^\bullet) is polymorphism-homogeneous.

Lemma 4.2. *Let \mathbb{A} be a two-element semilattice and let $C = \text{Clo}(\mathbb{A})$. Then the relational structure (A, C^\bullet) is not polymorphism-homogeneous.*

Proof. We can assume without loss of generality that $\mathbb{A} = (\{0, 1\}, \wedge)$ with the usual ordering $0 < 1$. Let us consider the equation $x \wedge y \wedge z = x \wedge y$. Obviously, the solution set $S = \{0, 1\}^3 \setminus \{(1, 1, 0)\}$ of this equation is defined by a quantifier-free primitive positive formula over C° . The nontrivial 3-variable equalities that can appear in a quantifier-free primitive positive formula over C^\bullet are the following:

$$\begin{array}{ccccc} x = y, & x = x \wedge y, & x = x \wedge z, & x = y \wedge z, & x = x \wedge y \wedge z, \\ y = z, & y = x \wedge y, & y = x \wedge z, & y = y \wedge z, & y = x \wedge y \wedge z, \\ z = x, & z = x \wedge y, & z = x \wedge z, & z = y \wedge z, & z = x \wedge y \wedge z. \end{array}$$

It is easy to check that S does not satisfy any of the equalities above; therefore, S cannot be defined by a quantifier-free primitive positive formula over C^\bullet . Thus S belongs to $\langle C^\circ \rangle_{\#}$ but not to $\langle C^\bullet \rangle_{\#}$, hence (A, C^\bullet) is not polymorphism-homogeneous by Proposition 3.5. \square

Theorem 4.3. *If \mathbb{A} is a nontrivial finite semilattice and $C = \text{Clo}(\mathbb{A})$, then the relational structure (A, C^\bullet) is not polymorphism-homogeneous.*

Proof. Let $a, b \in A$ such that $a < b$, and let us consider the same equation as in the proof of Lemma 4.2. Now for the solution set S of this equation we have that $S \cap \{a, b\}^3 = \{a, b\}^3 \setminus \{(b, b, a)\}$. The same argument as in the proof of Lemma 4.2 shows that S cannot be defined by a quantifier-free primitive positive formula over C^\bullet . \square

4.2 Lattices

For finite lattices the situation is very similar to the case of semilattices: five of the six conditions of Figure 1 are equivalent, and the sixth one is satisfied only by trivial lattices.

Theorem 4.4. *If \mathbb{A} is a finite lattice and $C = \text{Clo}(\mathbb{A})$, then the following conditions are equivalent:*

- (i) \mathbb{A} has property (SDC);
- (ii) \mathbb{A} is polymorphism-homogeneous;
- (iii) (A, C°) is polymorphism-homogeneous;
- (iv) \mathbb{A} is injective in $\text{SP}_{\text{fin}}(\mathbb{A})$;
- (v) \mathbb{A} is injective in $\text{HSP}(\mathbb{A})$;
- (vi) \mathbb{A} is a finite Boolean lattice (i.e., a direct power of the two-element chain).

Proof. Just as in the proof of Theorem 4.1, the equivalence of (i)–(iv) follows from Corollary 3.4, (v) trivially implies (iv), and the equivalence of (i) and (vi) is Theorem 4.8 of [3]. (Let us mention that I. Dolinka and D. Mašulović [13] proved that a finite lattice is homomorphism-homogeneous if and only if it is a chain or a Boolean lattice. This together with Proposition 2.2 can also be used to prove that (ii) and (vi) are equivalent.) To complete the proof, it suffices to prove that (vi) implies (v). This follows immediately from a result of R. Balbes [14]: the injective objects in the category of distributive lattices are the complete Boolean lattices (observe that if \mathbb{A} is a nontrivial Boolean lattice, then $\text{HSP}(\mathbb{A})$ is the variety of distributive lattices). \square

Lemma 4.5. *Let \mathbb{A} be a two-element lattice and let $C = \text{Clo}(\mathbb{A})$. Then the relational structure (A, C^\bullet) is not polymorphism-homogeneous.*

Proof. We can assume without loss of generality that $\mathbb{A} = (\{0, 1\}, \vee, \wedge)$ with the usual ordering $0 < 1$. Let us consider the equation $(x_1 \vee x_2) \wedge (x_3 \wedge x_4) = x_3 \wedge x_4$; the solution set $S = \{0, 1\}^4 \setminus \{(0, 0, 1, 1)\}$ of this equation is defined by a quantifier-free primitive positive formula over C° . If S can be defined by a quantifier-free primitive positive formula Φ over C^\bullet , then we can assume without loss of generality that Φ consists of a single equality, as S misses only one element of $\{0, 1\}^4$ (in other words, S is meet-irreducible in the lattice of subsets of $\{0, 1\}^4$). Thus S is the solution set of an equation of the form $f(x_1, x_2, x_3, x_4) = u$, where $u \in \{x_1, x_2, x_3, x_4\}$. Note that since f is generated by the lattice operations \vee and \wedge , it is a monotone function. We consider four cases corresponding to the variable u .

1. If $u = x_1$, then $f(x_1, x_2, x_3, x_4) = x_1$ holds for all $(x_1, x_2, x_3, x_4) \in S$ and $f(0, 0, 1, 1) = 1$. In particular, we have $f(0, 1, 1, 1) = 0 < 1 = f(0, 0, 1, 1)$, contradicting the monotonicity of f .
2. If $u = x_2$, then $f(x_1, x_2, x_3, x_4) = x_2$ holds for all $(x_1, x_2, x_3, x_4) \in S$ and $f(0, 0, 1, 1) = 1$. In particular, we have $f(1, 0, 1, 1) = 0 < 1 = f(0, 0, 1, 1)$, contradicting the monotonicity of f .
3. If $u = x_3$, then $f(x_1, x_2, x_3, x_4) = x_3$ holds for all $(x_1, x_2, x_3, x_4) \in S$ and $f(0, 0, 1, 1) = 0$. In particular, we have $f(0, 0, 1, 0) = 1 > 0 = f(0, 0, 1, 1)$, contradicting the monotonicity of f .
4. If $u = x_4$, then $f(x_1, x_2, x_3, x_4) = x_4$ holds for all $(x_1, x_2, x_3, x_4) \in S$ and $f(0, 0, 1, 1) = 0$. In particular, we have $f(0, 0, 0, 1) = 1 < 0 = f(0, 0, 1, 1)$, contradicting the monotonicity of f .

We see that S cannot be defined by a quantifier-free primitive positive formula Φ over C^\bullet , hence $\langle C^\circ \rangle_{\#} \neq \langle C^\bullet \rangle_{\#}$, and thus (A, C^\bullet) is not polymorphism-homogeneous by Proposition 3.5. \square

Theorem 4.6. *If \mathbb{A} is a nontrivial finite lattice and $C = \text{Clo}(\mathbb{A})$, then the relational structure (A, C^\bullet) is not polymorphism-homogeneous.*

Proof. Let $a, b \in A$ such that $a < b$, and let us consider the same equation as in the proof of Lemma 4.5. Now for the solution set S of this equation we have that $S \cap \{a, b\}^4 = \{a, b\}^4 \setminus \{(a, a, b, b)\}$. If S can be defined by a quantifier-free primitive positive formula Φ over C^\bullet , then at least one of the equalities in Φ defines the set $\{a, b\}^4 \setminus \{(a, a, b, b)\}$ when restricted to the sublattice $\{a, b\}$, and this leads to a contradiction using the same argument as in the proof of Lemma 4.5. \square

4.3 Abelian groups

For Abelian groups all six conditions of Figure 1 are equivalent, and these groups have already been determined, so we only need to combine some results from the literature to prove the following theorem.

Theorem 4.7. *If \mathbb{A} is a finite Abelian group and $C = \text{Clo}(\mathbb{A})$, then the following conditions are equivalent:*

- (i) \mathbb{A} has property (SDC);
- (ii) \mathbb{A} is homomorphism-homogeneous;
- (iii) \mathbb{A} is polymorphism-homogeneous;
- (iv) (A, C°) is polymorphism-homogeneous;
- (v) (A, C^\bullet) is polymorphism-homogeneous;
- (vi) \mathbb{A} is injective in $\text{SP}_{\text{fin}}(\mathbb{A})$;
- (vii) \mathbb{A} is injective in $\text{HSP}(\mathbb{A})$;
- (viii) each Sylow-subgroup of \mathbb{A} is homocyclic, i.e., $\mathbb{A} \cong \mathbb{Z}_{q_1}^{m_1} \times \cdots \times \mathbb{Z}_{q_k}^{m_k}$, where q_1, \dots, q_k are powers of different primes and $m_1, \dots, m_k \in \mathbb{N}$.

Proof. Conditions (i), (iii), (iv) and (vi) are equivalent by Corollary 3.4. It is clear that (iv) is equivalent to (v), since we have $C^\bullet = C^\circ$ for groups: every equality can be written in an equivalent form where there is only a single variable on the right hand side. The equivalence of (ii) and (viii) follows from the description of quasi-injective Abelian groups presented as an exercise in [15] (for finite groups quasi-injectivity is equivalent to homomorphism-homogeneity). The class of groups given in (viii) is closed under taking finite direct powers, so we can conclude with the help of Proposition 2.2 that (iii) and (viii) are equivalent. It seems to be a folklore fact that the injective members of the variety of Abelian groups defined by the identity $nx = 0$ with $n = q_1 \cdot \dots \cdot q_k$ are exactly the groups given by (viii) (see, e.g., [16]). Therefore, (viii) implies (vii), and this completes the proof, as (vii) trivially implies (vi). \square

4.4 Monounary algebras

A *monounary algebra* is an algebra $\mathbb{A} = (A, f)$ with a single unary operation $f \in \mathcal{O}_A^{(1)}$. An element $a \in A$ is *cyclic* if there is a natural number k such that $f^k(a) = a$. (Here $f^k(a)$ stands for $f(\cdots f(a) \cdots)$ with a k -fold repetition of f , and we also use the convention $f^0(a) = a$.) If A is finite, then for every element $a \in A$ there is a least nonnegative integer $\text{ht}(a)$, called the *height* of a , such that $f^{\text{ht}(a)}(a)$ is cyclic. If $a \in A \setminus f(A)$, i.e., a has no preimage, then we say that a is a *source*. (Note that $\text{ht}(a) = 0$ if and only if a is cyclic; in particular, $\text{ht}(a) \geq 1$ for any source a .)

Polymorphism-homogeneous monounary algebras were characterized by Z. Farkasová and D. Jakubíková-Studenovská in [9] using Proposition 2.2 and the description of homomorphism-homogeneous monounary algebras obtained by É. Jungábel and D. Mašulović [17].

Theorem 4.8 ([9]). *If $\mathbb{A} = (A, f)$ is a finite monounary algebra and $C = \text{Clo}(\mathbb{A})$, then the following conditions are equivalent:*

- (i) \mathbb{A} has property (SDC);
- (ii) \mathbb{A} is polymorphism-homogeneous;
- (iii) (A, C°) is polymorphism-homogeneous;
- (iv) \mathbb{A} is injective in $\text{SP}_{\text{fin}}(\mathbb{A})$;
- (v) Either \mathbb{A} has no sources, or all sources of \mathbb{A} have the same height: $\forall a, b \in A \setminus f(A): \text{ht}(a) = \text{ht}(b)$.

Proof. Conditions (i)–(iv) are equivalent by Corollary 3.4, and the equivalence of (ii) and (v) follows from Theorem 5 of [17] and Theorem 4.3 of [9], specialized to finite monounary algebras. \square

Next we determine finite monounary algebras corresponding to the top left box of Figure 1.

Theorem 4.9. *Let $\mathbb{A} = (A, f)$ be a finite monounary algebra, and let $C = \text{Clo}(\mathbb{A})$. Then the relational structure (A, C^\bullet) is polymorphism-homogeneous if and only if f is either bijective or constant.*

Proof. If f is constant, then it is clear that (A, C^\bullet) is polymorphism-homogeneous. Assume now that f is bijective. Then the condition of Theorem 4.8 is satisfied (there are no sources at all), so \mathbb{A} is polymorphism-homogeneous, and thus by Theorem 3.2 (A, C°) is polymorphism-homogeneous as well. Therefore, by Proposition 3.5, it suffices to show that $\langle C^\circ \rangle_{\#} = \langle C^\bullet \rangle_{\#}$. This is clear, as any equality of the form $f^k(x) = f^\ell(x)$ with $k < \ell$ is equivalent to $x = f^{\ell-k}(x)$, since f is bijective.

For the other direction, let us suppose that (A, C^\bullet) is polymorphism-homogeneous. By Proposition 3.5, (A, C°) is also polymorphism-homogeneous, and then Theorem 4.8 (together with Theorem 3.2) implies that either there are no sources, or there is an integer $n \geq 1$ such that every source in \mathbb{A} has height n . If there are no sources in \mathbb{A} , then every element is cyclic, and therefore f is bijective. From now on let us suppose that \mathbb{A} has sources with a common height n . Proposition 3.5 shows that there exists a quantifier-free primitive positive formula $\Phi(x, y)$ over C^\bullet such that $\Phi(x, y)$ is equivalent to $f(x) = f(y)$. We can write $\Phi(x, y)$ in the following form:

$$\Phi(x, y) = \bigwedge_{i=1}^t (f^{r_i}(u_i) = v_i),$$

where t, r_i are nonnegative integers, and $u_i, v_i \in \{x, y\}$ for $i = 1, \dots, t$. Obviously, $\Phi(a, a)$ holds for every element $a \in A$. Let us choose a to be of height n , i.e., let a be a source. Then $f^{r_i}(u_i) = v_i$ holds for $u_i = v_i = a$ if and only if $r_i = 0$, thus $\Phi(x, y)$ is equivalent either to $x = y$ or to $x = x$. Taking into account that $\Phi(x, y)$ is also equivalent to $f(x) = f(y)$, we can conclude that $f(x) = f(y) \iff x = y$ or $f(x) = f(y) \iff x = x$. In the first case f is a bijection, and in the second case f is constant. \square

Injective objects in the category of all monounary algebras were determined by D. Jakubíková-Studenovská [18]; in the finite case these are exactly the monounary algebras $\mathbb{A} = (A, f)$ where f is bijective and has a fixed point. However, in order to complete the picture of Figure 1 for monounary algebras, we need to describe those monounary algebras \mathbb{A} that are injective in the variety $\text{HSP } \mathbb{A}$. This has been done by D. Jakubíková-Studenovská and G. Czédli, but this result appeared only in Hungarian in the masters thesis [19] of T. Jéges, a student of G. Czédli.

Theorem 4.10 ([19]). *A finite monounary algebra $\mathbb{A} = (A, f)$ is injective in the variety $\text{HSP}(\mathbb{A})$ if and only if all of its sources have the same height and it has a one-element subalgebra (i.e., f has a fixed point).*

Let us note that comparing theorems 4.8, 4.9 and 4.10, one can construct examples illustrating each one of the “non-implications” of Figure 1.

Acknowledgements

The authors are grateful to Dragan Mašulović and Christian Pech for helpful discussions.

This research was partially supported by the National Research, Development and Innovation Office of Hungary under grants K115518 and K128042.

References

- [1] Christian Pech and Maja Pech. On polymorphism-homogeneous relational structures and their clones. *Algebra Universalis*, 73(1):53–85, 2015.
- [2] Boris Plotkin. Some results and problems related to universal algebraic geometry. *Internat. J. Algebra Comput.*, 17(5-6):1133–1164, 2007.
- [3] Endre Tóth and Tamás Waldhauser. Solution sets of systems of equations over finite lattices and semilattices. *Algebra Universalis*, 81(2):13, 2020.
- [4] Endre Tóth and Tamás Waldhauser. On the shape of solution sets of systems of (functional) equations. *Aequationes Math.*, 91(5):837–857, 2017.
- [5] V. G. Bodnarčuk, L. A. Kalužnin, V. N. Kotov, and B. A. Romov. Galois theory for Post algebras. I, II. *Kibernetika (Kiev)*, (3):1–10; *ibid.* 1969, no. 5, 1–9, 1969.
- [6] David Geiger. Closed systems of functions and predicates. *Pacific J. Math.*, 27:95–100, 1968.
- [7] B. A. Romov. The algebras of partial functions and their invariants. *Kibernetika (Kiev)*, (2):i, 1–11, 149, 1981.
- [8] Peter J. Cameron and Jaroslav Nešetřil. Homomorphism-homogeneous relational structures. *Combin. Probab. Comput.*, 15(1-2):91–103, 2006.

- [9] Zuzana Farkasová and Danica Jakubíková-Studenovská. Polymorphism-homogeneous monounary algebras. *Math. Slovaca*, 65(2):359–370, 2015.
- [10] L. G. Kovács and M. F. Newman. Injectives in varieties of groups. *Algebra Universalis*, 14(3):398–400, 1982.
- [11] G. Bruns and H. Lakser. Injective hulls of semilattices. *Canad. Math. Bull.*, 13:115–118, 1970.
- [12] Alfred Horn and Naoki Kimura. The category of semilattices. *Algebra Universalis*, 1(1):26–38, 1971.
- [13] Igor Dolinka and Dragan Mašulović. Remarks on homomorphism-homogeneous lattices and semilattices. *Monatsh. Math.*, 164(1):23–37, 2011.
- [14] Raymond Balbes. Projective and injective distributive lattices. *Pacific J. Math.*, 21:405–420, 1967.
- [15] László Fuchs. *Infinite abelian groups. Vol. I.* Pure and Applied Mathematics, Vol. 36. Academic Press, New York-London, 1970.
- [16] O. C. García and F. Larión. Injectivity in varieties of groups. *Algebra Universalis*, 14(3):280–286, 1982.
- [17] Éva Jungábel and Dragan Mašulović. Homomorphism-homogeneous monounary algebras. *Math. Slovaca*, 63(5):993–1000, 2013.
- [18] Danica Jakubíková-Studenovská. Retract injective and retract projective monounary algebras. In *Contributions to general algebra, 10 (Klagenfurt, 1997)*, pages 207–214. Heyn, Klagenfurt, 1998.
- [19] Tünde Jeges. *Injektív algebrák.* University of Szeged, Hungary, 2000. Thesis (MA in Mathematics Education)–University of Szeged (Hungary).

TERMINATION OF GRAPH REWRITING SYSTEMS THROUGH LANGUAGE THEORY

Guillaume Bonfante

Université de Lorraine, CNRS, LORIA
F-54000 Nancy, France
guillaume.bonfante@univ-lorraine.fr

Miguel Couceiro

Université de Lorraine, CNRS, Inria, LORIA
F-54000 Nancy, France
miguel.couceiro@loria.fr

Dedicated to Maurice Pouzet on the occasion of his 75th birthday

ABSTRACT

The termination issue that we tackle is rooted in Natural Language Processing where computations are performed by graph rewriting systems (GRS) that may contain a large number of rules, often in the order of thousands. This asks for algorithmic procedures to verify the termination of such systems. The notion of graph rewriting that we consider does not make any assumption on the structure of graphs (they are not “term graphs”, “port graphs” nor “drags”). This lack of algebraic structure led us to proposing two orders on graphs inspired from language theory: the matrix multiset-path order and the rational embedding order. We show that both are stable by context, which we then use to obtain the main contribution of the paper: under a suitable notion of “interpretation”, a GRS is terminating if and only if it is compatible with an interpretation.

Keywords Graph Rewriting · Termination · Order · Natural Language Processing

1 Introduction

Computer linguists rediscovered a few years ago that graph rewriting is a good model of computation for rule-based systems. They used traditionally terms, see for instance Chomsky’s Syntagmatic Structures [1]. But usual phenomena such as anaphora do not fit really well within such theories. In such situations, graphs behave much better. For examples of graph rewriting in natural language processing, we refer the reader to the parsing procedure by Guillaume and Perrier [2] or the word ordering modeling by Kahane and Lareau [3]. The first named author with Guillaume and Perrier designed a graph rewriting model called GREW [4] that is adapted to natural language processing.

The rewriting systems developed by the linguists often contain a huge number of rules, e.g., those synthesized from lexicons (e.g. some rules only apply to transitive verbs). For instance, in [2], several systems are presented, some with more than a thousand of rules. Verifying properties such as termination by hand thus becomes intractable. This fact motivates our framework for tackling the problem of GRS termination.

Following the tracks of term rewriting, for which the definition is essentially fixed by the algebraic structure of terms, many approaches to graph rewriting emerged in past years. Some definitions (here meaning semantics) are based on a categorical framework, e.g., the double pushout (DPO) and the single pushout (SPO) models, see [5]. To make use of algebraic potential, some authors make some, possibly weak, hypotheses on graph structures, see for instance the main contribution by Courcelle and Engelfriet [6] where graph decompositions, graph operations and transformations are described in terms of monadic second-order logics (with the underlying decidability/complexity results). In this spirit, Ogawa describes a graph algebra under a limited tree-width condition [7].

Another line of research follows from the seminal work by Lafont [8] on interaction nets. The latter are graphs where nodes have some extra structure: nodes have a label related to some arity and co-arity. Moreover, nodes have some “principal gates” (ports) and rules are actionned via them. One of the main results by Lafont is that rewriting in this setting is (strongly) confluent. This approach has been enriched by Fernandez, Kirchner and Pinaud [9],

who implemented a fully operational system called PORGY with strategies and related semantics. Also, it is worth mentioning the graph rewriting as described by Dershowitz and Jouannaud [10]. Here, graphs are seen as a generalization of terms: symbols have a (fixed) arity, graphs are connected via some sprouts/variables as terms do. With such a setting, a good deal of term rewriting theory also applies to graphs.

Let us come back to the initial problem: termination of graph rewriting systems in the context of natural language processing. We already mentioned that rule sets are large, which makes manual inspection impossible. Moreover, empirical studies fail to observe some of the underlying hypotheses of the previous frameworks. For instance, there is no clear bound on tree-width: even if input data such as dependency graphs are almost like trees, the property is not preserved along computations. Also, constraints on node degrees are also problematic: graphs are usually sparse, but some nodes may be highly connected. To illustrate, consider the sentence “The woman, the man, the child and the dog eat together”. The verb “eat” is related to four subjects and there is no a priori limit on this phenomenon. Typed versions (those with fixed arity) are also problematic: a verb may be transitive or not. Moreover, rewriting systems may be intrinsically nondeterministic. For instance, if one computes the semantics of a sentence out of its grammatical analysis, it is quite common there are multiple solutions. To further illustrate nondeterminism consider the well known phrasal construction “He saw a man with a telescope” with two clear readings.

Some hypotheses are rather unusual for standard computations, e.g., fixed number of nodes. Indeed, nodes are usually related to words or concepts (which are themselves closely related to words). A paraphrase may be a little bit longer than its original version, but its length can be easily bounded by the length of the original sentence up to some linear factor. In GREW, node creations are restricted. To take into account the rare cases for which one needs extra nodes, a “reserve” is allocated at the beginning of the computation. All additional nodes are taken from the reserve. Doing so has some efficiency advantages, but that goes beyond the scope of the paper. Also, node and edge labels, despite being large, remain finite sets: they are usually related to some lexicons. These facts together have an important impact on the termination problem: since there are only finitely many graphs of a given size, rewriting only leads to finitely many outcomes. Thus, deciding termination for a *particular input graph* is decidable. However, our problem is to address termination in the class of *all* graphs. The latter problem is often referred to as *uniform termination*, whereas the former is referred to as *non-uniform*. For word rewriting, uniform termination of non increasing systems constituted a well known problem, and was shown to be undecidable by Sénizergues in [11].

This paper proposes a novel approach for termination of graph rewriting. In a former paper [12], we proposed a solution based on label weights. Here, the focus is on the description (and the ordering) of paths within graphs. In fact, paths in a graph can be seen as good old regular languages. The question of path ordering thus translates into a question of regular language orderings. Accordingly, we define the *graph multi-set path ordering* that is related to that in [13]. Dershowitz and Jouannaud, in the context of drag rewriting, consider a similar notion of path ordering called GPO (see [14]). Our definitions diverge from theirs in that our graph rewriting model is quite different: here, we do not benefit (as they do) from a good algebraic structure. Our graphs have no heads, tails nor hierarchical decomposition. In fact, our ordering is not even well founded! Relating the two notions is nevertheless interesting and left for further work. Plump [15] also defines path orderings for term graphs, but those behave like sets of terms.

One of our graph orderings will involve matrices, and orderings on matrices. Nonetheless, as far as we see, there is no relationship with matrix interpretations as defined by Endrullis, Waldmann and Zantema [16].

The paper is organized as follows. In Section 2 we recall the basic background on graphs and graph rewriting systems (GRS) that we will need throughout the paper, and introduce an example that motivated our work. In Section 3 we consider a language theory approach to the termination of GRSs. In particular, we present the language matrix, and the matrix multiset path order (Subsection 3.4) and the rational embedding order (Subsection 3.5). We also propose the notion of stability by context (Subsection 3.6) and show that both orderings are stable under this condition (Subsection 3.7). In Section 4 we propose notion of graph interpretability and show one of our main results, namely, that a GRS is terminating if and only if it is compatible with interpretations.

Main contributions: The two main contributions of the paper are the following.

1. We propose two orders on graphs inspired from language theory, and we show that both are monotonic and stable by context.
2. We propose a notion of graph interpretation, and show that GRSs that are terminating are exactly those that are compatible with such interpretations.

2 Notation and Graph Rewriting

In this section we recall some general definitions and notation. Given an alphabet Σ , the set of words (finite sequences of elements of Σ) is denoted by Σ^* . The concatenation of two words v and w is denoted by $v \cdot w$. The empty word, being the neutral element for concatenation, is denoted by 1_Σ or, when clear from the context, simply by 1. Note that $\langle \Sigma^*, 1, \cdot \rangle$ constitutes a monoid.

A *language* on Σ is some subset $L \subseteq \Sigma^*$. The set of all languages on Σ is $\mathcal{P}(\Sigma^*)$. The addition of two languages $L, L' \subseteq \Sigma^*$ is defined by $L + L' = \{w \mid w \in L \vee w \in L'\}$. The empty language is denoted by 0 and $\langle \mathcal{P}(\Sigma^*), +, 0 \rangle$ is also a (commutative) monoid. Given some word $w \in \Sigma^*$, we will also denote by w the language made of the singleton $\{w\} \in \mathcal{P}(\Sigma^*)$. Given two languages $L, L' \subseteq \Sigma^*$, their concatenation is defined by $L \cdot L' = \{w \cdot w' \mid w \in L \wedge w' \in L'\}$. In this way, $\langle \mathcal{P}(\Sigma^*), 1, \cdot \rangle$ is also a monoid. Given the distributivity of \times with respect to $+$, the 5-tuple $\langle \mathcal{P}(\Sigma^*), +, 0, 1, \cdot \rangle$ forms a semiring.

A *preorder* on a set X is a binary relation $\preceq \subseteq X^2$ that is reflexive ($x \preceq x$, for all $x \in X$) and transitive (if $x \preceq y$ and $y \preceq z$, then $x \preceq z$, for all $x, y, z \in X$). A preorder \preceq is a *partial order* if it is anti-symmetric (if $x \preceq y$ and $y \preceq x$, then $x = y$, for all $x, y \in X$). An *equivalence relation* is a preorder that is symmetric ($x \preceq y \Rightarrow y \preceq x$). Observe that each preorder \preceq induces an equivalence relation \sim : $a \sim b$ if $a \preceq b$ and $b \preceq a$. The strict part of \preceq is then the relation: $x \prec y$ if and only if $x \preceq y$ and $\neg(x \sim y)$. We also mention the “dual” preorder \succeq of \preceq defined by: $x \succeq y$ if and only if $y \preceq x$. A preorder \preceq is said to be *well-founded* if there is no infinite chain $\dots \prec x_2 \prec x_1$ or, equivalently, $x_1 \succ x_2 \succ \dots$.

The remainder of this section may be found in [4] and we refer the reader to it for an extended presentation. We suppose given a (finite) set Σ_N of *node labels*, a (finite) set Σ_E of *edge labels* and we define graphs accordingly. A graph is a triple $G = \langle N, E, \ell \rangle$ with $E \subseteq N \times \Sigma_E \times N$ and $\ell : N \rightarrow \Sigma_N$ is the labeling function of nodes. Note that there may be more than one edge between two nodes, but at most one is labeled with some $e \in \Sigma_E$. In the sequel, we use the notation $m \xrightarrow{e} n$ for an edge $(m, e, n) \in E$.

Given a graph G , we denote by $\mathcal{N}_G, \mathcal{E}_G$ and ℓ_G respectively its sets of nodes, edges and labeling function. We will also (abusively) use the notation $m \in G$ and $m \xrightarrow{e} n \in G$ instead of $m \in \mathcal{N}_G$ and $m \xrightarrow{e} n \in \mathcal{E}_G$ when the context is clear. Furthermore, in $\textcircled{a} \xrightarrow{A} \textcircled{b}$, a, b are nodes, \clubsuit, \heartsuit are the respective node labels and A is the edge label (here between a and b).

The set of graphs on node labels Σ_N and edge labels Σ_E is denoted by $\mathcal{G}_{\Sigma_N, \Sigma_E}$ or \mathcal{G} in short. Two graphs G and G' are said to share their nodes when $\mathcal{N}_G = \mathcal{N}_{G'}$. Given two graphs G and G' such that $\mathcal{N}_G \subseteq \mathcal{N}_{G'}$, set $G \blacktriangleleft G' = \langle \mathcal{N}_{G'}, \mathcal{E}_G \cup \mathcal{E}_{G'}, \ell \rangle$ with $\ell(n) = \ell_G(n)$ if $n \in \mathcal{N}_G$ and $\ell(n) = \ell_{G'}(n)$, otherwise.

A graph morphism μ between a source graph G and a target graph H is a function $\mu : \mathcal{N}_G \rightarrow \mathcal{N}_H$ that preserves edges and labelings, that is, for all $m \xrightarrow{e} n \in G$, $\mu(m) \xrightarrow{e} \mu(n) \in H$ holds, and for any node $n \in G$: $\ell_G(n) = \ell_H(\mu(n))$. A *basic pattern* is a graph, and a *basic pattern matching* is an injective morphism from a basic pattern P to some graph G . Given such a morphism $\mu : G \rightarrow G'$, we define $\mu(G)$ to be the sub-graph of G' made of the nodes $\{\mu(n) \mid n \in \mathcal{N}_G\}$, of the edges $\{\mu(m) \xrightarrow{e} \mu(n) \mid m \xrightarrow{e} n \in G\}$ and node labels $\mu(n) \mapsto \ell_G(n)$.

A *pattern* is a pair $P = \langle P_0, \vec{\nu} \rangle$ made of a basic pattern P_0 and a sequence of injective morphisms $\nu_i : P_0 \rightarrow N_i$, called *negative conditions*. The basic pattern describes what must be *present* in the target graph G , whereas negative conditions say what must be *absent* in the target graph. Given a pattern $P = \langle P_0, \vec{\nu} \rangle$ and a graph G , a *pattern morphism* is an injective morphism $\mu : P_0 \rightarrow G$ for which there is no morphism ξ_i such that $\mu = \xi_i \circ \nu_i$.

Example 1. Consider the basic pattern morphism $\mu : P_0 \rightarrow G$ (colors define the mapping):

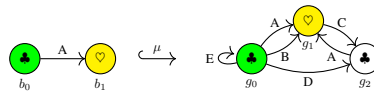

The pattern $P = \langle P_0, [\nu] \rangle$ with ν defined by $\textcircled{\clubsuit} \xrightarrow{A} \textcircled{\heartsuit} \xrightarrow{\nu} \textcircled{\heartsuit}$ prevents the application of the morphism above.

Indeed, $\xi = b_0 \mapsto g_0, b_1 \mapsto g_1$ is such that $\xi \circ \nu = \mu$. When there is only one negative condition, we represent the pattern by crossing nodes and edges which *are not* within the basic pattern. For instance, the pattern P above looks like

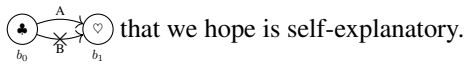

In this paper we think of graph transformations as sequences of “basic commands”.

Definition 1 (The command language). There are three basic commands: $\text{label}(p, \alpha)$ for node renaming, $\text{del_edge}(p, e, q)$ for edge deletion and $\text{add_edge}(p, e, q)$ for edge creation. In these basic commands, p and q are nodes, α is some node label and e is some edge label. A pattern $\langle P_0, \vec{v} \rangle$ is compatible with a command whenever all nodes that it involves belong to P_0 .

Definition 2 (Operational semantics). Given a pattern $P = \langle P_0, \vec{v} \rangle$ compatible with some command c , and some pattern matching $\mu : P \rightarrow G$ where G is the graph on which the transformation is applied, we have the following possible cases: $c = \text{label}(p, \alpha)$ turns the label of $\mu(p)$ into α , $c = \text{del_edge}(p, e, q)$ removes $\mu(p) \xrightarrow{e} \mu(q)$ if it exists, otherwise does nothing, and $c = \text{add_edge}(p, e, q)$ adds the edge $\mu(p) \xrightarrow{e} \mu(q)$ if it does not exist, otherwise does nothing. The graph obtained after such an application is denoted by $G \cdot_{\mu} c$. Given a sequence of commands $\vec{c} = (c_1, \dots, c_n)$, let $G \cdot_{\mu} \vec{c}$ be the resulting graph, i.e., $G \cdot_{\mu} \vec{c} = (\dots ((G \cdot_{\mu} c_1) \cdot_{\mu} c_2) \cdot_{\mu} \dots c_n)$.

Remark 1. We took a slightly simplified version of patterns. Actually, in [4], we have negative conditions within patterns to avoid some rule applications. But these simplifications should be transparent with respect to termination. Nevertheless, informally, we will omit the right node in a pattern like $\bigoplus_{b_0} \xrightarrow{B} \dots$ to say that there is no edge labeled B from node b_0 .

Definition 3. A rule is a pair $R = \langle P, \vec{c} \rangle$ made of a pattern and a (compatible) sequence of commands. Such a rule R applies to a graph G via a pattern morphism $\mu : P \rightarrow G$. Let $G' = G \cdot_{\mu} \vec{c}$, then we write $G \rightarrow_{R, \mu} G'$. We define $G \rightarrow G'$ whenever there is a rule R and a pattern morphism μ such that $G \rightarrow_{R, \mu} G'$.

2.1 The main example

Let $\Sigma_N = \{A\}$ and $\Sigma_E = \{\alpha, \beta, T\}$. For the discussion, we suppose that T is a working label, that is not present in the initial graphs. We want to add a new edge β between node n and node 1 each time we find a maximal chain:

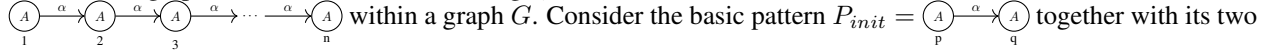

negative conditions $\nu_1 = \bigotimes \xrightarrow{\alpha} \bigcirc_p \xrightarrow{\alpha} \bigcirc_q$ and $\nu_2 = \bigotimes \xrightarrow{\beta} \bigcirc_p \xrightarrow{\alpha} \bigcirc_q$. We consider three rules:

Init: $\langle \langle P_{init}, [\nu_1, \nu_2] \rangle, (\text{add_edge}(p, T, q)) \rangle$ which fires the transitive closure.

Follow: $\langle \langle \bigcirc_p \xrightarrow{T} \bigcirc_q \xrightarrow{\alpha} \bigcirc_r \rangle, (\text{add_edge}(p, T, r), \text{del_edge}(p, T, q)) \rangle$ which follows the chain.

End: $\langle \langle \bigcirc_p \xrightarrow{T} \bigcirc_q \xrightarrow{\alpha} \bigotimes \rangle, (\text{del_edge}(p, T, q), \text{add_edge}(q, \beta, p)) \rangle$ which stops the procedure.

To prevent all pathological cases (e.g., when the edge β is misplaced, when two chains are crossing, and so on), we could introduce more sophisticated patterns. But, since that does not change issues around termination, we avoid obscuring rules with such technicalities.

Example 2. Consider the graph $G = \bigcirc_1 \xrightarrow{\alpha} \bigcirc_2 \xrightarrow{\alpha} \bigcirc_3$. By applying succesively 'Init', 'Follow' and 'End', G rewrites

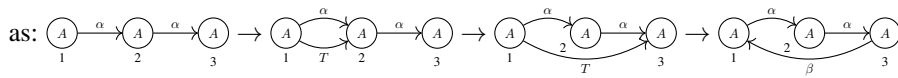

2.2 Three technical facts about Graph Rewriting

It is well known that the main issue with graph rewriting definitions is the way the context is related to the pattern image and its rewritten part. We shall tackle this issue with Proposition 1.

Self-application Let $R = \langle P, \vec{c} \rangle$ be the rule made of a pattern $P = \langle P_0, \vec{v} \rangle$ and a sequence of commands \vec{c} . There is the identity morphism $1_{P_0} : P_0 \rightarrow P_0$, and thus we can apply rule R on P_0 itself, that is, $P_0 \rightarrow_{R, 1_{P_0}} P'_0 = P_0 \cdot_{1_{P_0}} \vec{c}$. We call this latter graph the *self-application of R*.

Rule node renaming To avoid heavy notation, we will use the following trick. Suppose that we are given a rule $R = \langle P, \vec{c} \rangle$, a graph G and a pattern morphism $\mu : P \rightarrow G$. Let $P = \langle P_0, \vec{v} \rangle$. We define R_{μ} to be the rule obtained by renaming nodes p in P_0 to $\mu(p)$ (and their references within \vec{c}). For instance, the rule 'Follow' can be rewritten as $\text{Follow}_{\mu} = \langle \langle \bigcirc_1 \xrightarrow{T} \bigcirc_2 \xrightarrow{\alpha} \bigcirc_3 \rangle, (\text{add_edge}(1, T, 3), \text{del_edge}(1, T, 2)) \rangle$ where μ denotes the pattern morphism used to apply 'Follow' in the derivation. Observe that: (i) the basic pattern of R_{μ} is actually $\mu(P_0)$, which is a subgraph of

G , (ii) $\iota : \mu(P_0) \rightarrow G$ mapping $n \mapsto n$ is a pattern matching, and (iii) applying rule R_μ with ι is equivalent to applying rule R with μ . In other words, $G \rightarrow_{R,\mu} G'$ if (and only if) $G \rightarrow_{R,\mu,\iota} G'$. To sum up, we can always rewrite a rule so that its basic pattern is *actually* a subgraph of G .

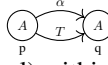
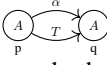
Uniform rules Let us consider rule 'Init' above. It applies on: , and the result is the graph itself: .

Indeed, we cannot add an already present edge (relative to a label) within a graph. Thus, depending on the graph, the rule will or will not append an edge. Such an unpredictable behavior can be easily avoided by modifying the pattern of

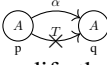
'Init' to: . The same issue may come from edge deletions. A *uniform* rule is one for which commands apply (that is, modify the graph) for each rule application. Since this is not the scope of the paper, we refer the reader to [4] for a precise definition of uniformity. We will only observe two facts.

First, any rule can be replaced by a finite set of uniform rules (using negative conditions as above) that operate identically. Thus, we can always suppose that rules are uniform.

Second, the following property holds for uniform rules (see [4]§7 for a proof).

Proposition 1. Suppose that $G \rightarrow_{R,\iota} G'$ with $R = \langle P, \vec{c} \rangle$ and $P = \langle P_0, \vec{v} \rangle$ (the basic pattern P_0 being a subgraph of G). Let C be the graph obtained from G by deleting the edges in P_0 . Then $G = P_0 \blacktriangleleft C$ and $G' = P'_0 \blacktriangleleft C$ with P'_0 being the self-application of the rule. Moreover, $\mathcal{E}_C \cap \mathcal{E}_{P_0} = \emptyset$ and $\mathcal{E}_C \cap \mathcal{E}_{P'_0} = \emptyset$.

Throughout the remainder of the paper we assume that all rules are uniform.

3 Termination of Graph Rewriting Systems

By a *graph rewriting system* (GRS) we simply mean a set of graph rewriting rules (see Section 2). A GRS \mathbf{R} is said to be *terminating* if there is no infinite sequence $G_1 \rightarrow G_2 \rightarrow \dots$. Such sequences, whether finite or not, are called *derivations*.

Since there is no node creation (neither node deletion) in our notion of rewriting, any derivation starting from a graph G will lead to graphs whose size is the size of G . Since there are only finitely many such graphs, we can decide the termination for this particular graph G . However, the question we address here is the *uniform termination problem* (see Section 1).

Remark 2. Suppose that we are given a strict partial order \succ , not necessarily well founded. If $G \rightarrow G'$ implies $G \succ G'$ for all graphs G and G' , then the system is terminating. Indeed, suppose it is not the case, let $G_1 \rightarrow G_2 \rightarrow \dots$ be an infinite reduction sequence. Since there are only finitely many graphs of size of G_1 , it means that there are two indices i and j such that $G_i \rightarrow \dots \rightarrow G_j$ with $G_i = G_j$. But then, since $G_i \succ G_{i+1} \succ \dots \succ G_j$, we have that $G_i \succ G_j = G_i$ which is a contradiction.

A similar argument was exhibited by Dershowitz in [17] in the context of term rewriting. For instance, it is possible to embed rewriting within real numbers rather than natural numbers to prove termination.

Let us try to prove the termination of our main example (see Subsection 2.1). Rules such as 'Init' and 'End' are "simple": we put a weight on edge labels $\omega : \Sigma_E \rightarrow \mathbb{R}$ and we say that the weight of a graph is the sum of the weights of its edges labels. Set $\omega(\alpha) = 0$, $\omega(\beta) = -2$ and $\omega(T) = -1$. Then, rules 'Init' and 'End' decrease the weight by 1 and, since rule 'Follow' keeps the weight constant, it means the two former rules can be applied only finitely many times. Observe that negative weights are no problem with respect to Remark 2.

But how do we handle rule 'Follow'? No weights as above can work.

3.1 A language point of view

Let $G \rightarrow G'$ be a rule application. The set of nodes stays constant. Let us think of graphs as automata, and let us forget about node labeling for the time being. Let Σ_E be the set of edge labels. Consider a pair of states (nodes), choose one to be the initial state and one to be the final state. Thus the automaton (graph) defines some regular language on Σ_E . In fact, the automaton describes n^2 languages (one for each pair of states).

Now, let us consider the effect of graph rewriting in terms of languages. Consider an application of the 'Follow' rule: $G \rightarrow G'$. Any word to state r that goes through the transitions $p \xrightarrow{T} q \xrightarrow{\alpha} r$ can be mapped to a shorter one in G' via the transition $p \xrightarrow{T} r$. The languages corresponding to state r contain shorter words. The remainder of this section is

devoted to formalizing this intuition into proper orders on graphs. For that, we will need to *count* the number of paths between any two states. Hence, we shall introduce \mathbb{N} -rational expressions, that is, *rational expression with multiplicity*. See, e.g., Sakarovitch's book [18] for an introduction and justifications of the upcoming constructions. We introduce here the basic ideas.

3.2 Formal series

A formal series on Σ (with coefficients in \mathbb{N}) is a (total) function $s : \Sigma^* \rightarrow \mathbb{N}$. Given a word w , $s(w)$ is the multiplicity of w . The set of words $\underline{s} = \{w \in \Sigma^* \mid s(w) \neq 0\}$ is the *support* of s . Given $n \in \mathbb{N}$, let \mathbf{n} be the series defined by $\mathbf{n}(w) = 0$, if $w \neq 1$, and $\mathbf{n}(1) = n$, where 1 denotes the empty word. The empty language is $\underline{0}$, the language made of the empty word is $\underline{1}$. Moreover, for $a \in \Sigma$, the series a is given by $a(w) = 0$ if $w \neq a$ and $a(a) = 1$.

Given two series s and t , their *addition* is the series $s + t$ given by $s + t(w) = s(w) + t(w)$, and their *product* is $s \cdot t$ defined by $s \cdot t(w) = \sum_{u \cdot v = w} s(u)t(v)$. The *star operation* is defined by $s^* = 1 + s + s^2 + \dots$. The monoid Σ^* being graded, the operation is correctly defined whenever $s(1) = 0$.

Given a series s , let $s^{\leq k}$ be its restriction to words of length less or equal to k , i.e., $s^{\leq k}(w) = 0$ whenever $|w| > k$ and $s^{\leq k}(w) = s(w)$, otherwise.

An \mathbb{N} -rational expression on an alphabet Σ is built upon the grammar [19]:

$$E ::= a \in \Sigma \mid n \in \mathbb{N} \mid (E + E) \mid (E \cdot E) \mid (E^*).$$

Thus, given the constructions mentioned in the previous paragraph, any \mathbb{N} -rational expression $E \in E$ denotes some formal series. To each \mathbb{N} -rational expression corresponds an \mathbb{N} -automaton, which is a standard automaton with transitions labeled by a non empty linear combination $\sum_{i \leq k} n_i a_i$ with $n_i \in \mathbb{N}$ and $a_i \in \Sigma$ for all $i \leq k$.

3.3 The language matrix

Let us suppose given an edge label set Σ_E . Let E denote the \mathbb{N} -rational expressions over Σ_E . A matrix M of dimension $P \times P$ for some (finite) set P is an array $(M_{i,j})_{i \in P, j \in P}$ whose entries are in E . Let \mathfrak{M}_E be the set of such matrices. Given a graph G , we define the matrix M_G of dimension $\mathcal{N}_G \times \mathcal{N}_G$ as follows: $M_{G,i,j} = T_1 + \dots + T_\ell$ with T_1, \dots, T_ℓ the set of labels on the transitions between state i and j if such transitions exist, otherwise 0.

Let 1_P be the unit matrix of dimension $P \times P$, that is $(1_P)_{i,j} = 0$ if $i \neq j$ else 1. From now on, we abbreviate the notation from 1_P to 1 if the context is clear. Then, let $M_G^* = 1 + M_G + M_G^2 + \dots$. Each entry of M_G^* is actually an \mathbb{N} -regular expression (see Sakarovitch Ch. III, §4 for instance). The (infinite) sum is correctly defined since for all i, j , we have the equality $(M_G)_{i,j} = T_1 + \dots + T_\ell$. Thus, $1 \notin (M_G)_{i,j}$.

The question about termination can be reformulated in terms of matrices whose entries are languages (with words counted with their multiplicity). To prove the termination of the rewriting system, it is then sufficient to exhibit some order $>$ on matrices such that for any two graphs $G \rightarrow G'$, we have $M_G^* > M_{G'}^*$. To prove such a property in the infinite class of finite graphs, we will use the notion of "stable orders".

Recall the 'Follow' rule and consider the corresponding basic pattern L and its self-application R . Their respective matrices are:

$$M_L = \begin{pmatrix} 0 & T & 0 \\ 0 & 0 & \alpha \\ 0 & 0 & 0 \end{pmatrix} \quad M_R = \begin{pmatrix} 0 & 0 & T \\ 0 & 0 & \alpha \\ 0 & 0 & 0 \end{pmatrix}.$$

Observe that $(M_R)_{13} > (M_L)_{13}$. This matrix deals with edges/transitions. In order to consider paths, we need to compute M_L^* and M_R^* that are given by:

$$M_L^* = \begin{pmatrix} 1 & T & T \cdot \alpha \\ 0 & 1 & \alpha \\ 0 & 0 & 1 \end{pmatrix} \quad M_R^* = \begin{pmatrix} 1 & 0 & T \\ 0 & 1 & \alpha \\ 0 & 0 & 1 \end{pmatrix}.$$

Any word within M_R^* 's entries is a sub-word of the corresponding entry in M_L^* .

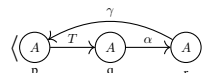
Example 3. Consider now a variation of 'Follow' made of the pattern  and commands $(\text{add_edge}(p, T, r), \text{del_edge}(p, T, q))$. By setting L' as its pattern and R' as its self-application, we get the following

matrices:

$$M_{L'}^* = \begin{pmatrix} (T\alpha\gamma)^* & T(\alpha\gamma T)^* & T\alpha(\gamma T\alpha)^* \\ \alpha\gamma(T\alpha\gamma)^* & (\alpha\gamma T)^* & \alpha(\gamma T\alpha)^* \\ \gamma(T\alpha\gamma)^* & \gamma T(\alpha\gamma T)^* & (\gamma T\alpha)^* \end{pmatrix} \quad M_{R'}^* = \begin{pmatrix} (T\gamma)^* & 0 & T(\gamma T)^* \\ \alpha\gamma(T\gamma)^* & 1 & \alpha(\gamma T)^* \\ \gamma(T\gamma)^* & 0 & (\gamma T)^* \end{pmatrix}.$$

Again, words within $M_{R'}^*$ are sub-words of the corresponding ones in $M_{L'}^*$.

3.4 The matrix multiset path order

The order we shall introduce in this section is inspired by the notion of *multiset path ordering* within the context of term rewriting (see for instance [13]). However, in the present context of graph rewriting (to be compared with Dershowitz and Jouannaud's [14] or with Plump's [15]), the definition is a bit more complicated. Here, we do not consider an order on letters as it is done for terms.

Let \trianglelefteq be the word embedding on Σ^* , that is, the smallest partial order such that $1 \trianglelefteq w$, and if $u \trianglelefteq v$, then $(u \cdot w \trianglelefteq v \cdot w$ and $w \cdot u \trianglelefteq w \cdot v$, for all $u, v, w \in \Sigma^*$. This order \trianglelefteq can be extended to formal series, that is, the multiset-path ordering, see Dershowitz and Manna [20] or Huet and Oppen [21].

Definition 4 (Multiset path order). The *multiset path order* is the smallest partial order on finite series such that

- if there is $w \in \underline{t}$ such that for all $v \in \underline{s}$, $v \triangleleft w$, then $s \trianglelefteq t$, and
- if $r \trianglelefteq s$ and $t \trianglelefteq u$, then $r + t \trianglelefteq s + u$.

We write $s \triangleleft t$ when $s \trianglelefteq t$ and $s \neq t$.

Proposition 2. Addition and product are monotonic with respect to the multiset-path order. Moreover, addition is strictly monotonic with respect to \trianglelefteq , and if $r \triangleleft s$, then $r \cdot t \triangleleft s \cdot t$ and $t \cdot r \triangleleft t \cdot s$, whenever $t \neq 0$ (otherwise, we have equality).

Proof. Addition is monotonic by definition. Actually, we prove now that it is strictly monotonic. Suppose that $r \triangleleft s$. We prove that $r + t \triangleleft s + t$, by induction (see Definition 4). Suppose that there is $w \in \underline{s}$ such that for all $v \in \underline{r}$ we have $v \triangleleft w$, then $r \triangleleft s$. Since $r(w) = 0$, then $(r + t)(w) = t(w) < s(w) + t(w) = (s + t)(w)$, and we are done. Otherwise, $r = r_0 + r_1$ and $s = s_0 + s_1$ with $r_0 \trianglelefteq s_0$ and $r_1 \trianglelefteq s_1$. One of the two inequalities must be strict (otherwise $r = s$). Suppose $r_0 \triangleleft s_0$. By definition, observe that $r_1 + t \trianglelefteq s_1 + t$. But then, $r + t = r_0 + (r_1 + t)$ and $s + t = s_0 + (s_1 + t)$ and we apply induction on (r_0, s_0) . As addition is commutative, the result holds.

For the product, suppose that $r \trianglelefteq s$ and let t be some series. We prove $r \cdot t \trianglelefteq s \cdot t$; the other inequality $t \cdot r \trianglelefteq t \cdot s$ is similar. Again, we proceed by induction on Definition 4:

- Suppose there is $w \in \underline{s}$ such that for all $v \in \underline{r}$, $v \triangleleft w$. By induction on t , if $t = 0$, $r \cdot t = 0 \trianglelefteq 0 = s \cdot t$. Otherwise, $t = t_0 + v_0$ for a word v_0 . Observe that $r \cdot v_0 = \sum_{v \in \underline{r}} r(v)v \cdot v_0$. Since for all $v \in \underline{r}$, $v \cdot v_0 \triangleleft w \cdot v_0$, we have $r \cdot v_0 \triangleleft w \cdot v_0 \trianglelefteq s \cdot v_0$. Now, $r \cdot t = r \cdot (t_0 + v_0) = r \cdot t_0 + r \cdot v_0$ and $s \cdot t = s \cdot t_0 + s \cdot v_0$. By induction, $r \cdot t_0 \trianglelefteq s \cdot t_0$ and since $r \cdot v_0 \trianglelefteq s \cdot v_0$, the result holds.
- Otherwise, $r = r_0 + r_1$. In this case, $s \cdot r = s \cdot r_0 + s \cdot r_1$ and $t \cdot r = t \cdot r_0 + t \cdot r_1$. The result then follows by induction.

To show strict monotonicity, suppose $r \triangleleft s$ and again proceed by case analysis. Suppose that there is some $w \in \underline{s}$ such that for all $v \in \underline{r}$, $v \triangleleft w$. Since $t \neq 0$, it contains at least one word v_0 such that $t = t_0 + v_0$. By $r \triangleleft s$, $r \cdot v_0 = \sum_{v \in \underline{r}} r(v)v \cdot v_0 \triangleleft \sum_{v \in \underline{s}} s(v)v \cdot v_0 = s \cdot v_0$. Now, $r \cdot t_0 \trianglelefteq s \cdot t_0$ by monotonicity. Thus $r \cdot t = r \cdot t_0 + r \cdot v_0 \triangleleft s \cdot t_0 + s \cdot v_0 = s \cdot t$ where the strict inequality is due to strict monotonicity of addition. \square

Definition 5 (Matrix multiset-path order). Let M and M' be two matrices with dimension $P \times P$. Write $M \trianglelefteq M'$ if for all $k \geq |P|$ and for all $(i, j) \in P \times P$, we have $M_{i,j}^{\leq k} \trianglelefteq M'_{i,j}^{\leq k}$.

Corollary 1. The addition and the multiplication are monotonic with respect to the matrix multiset-path order.

Proof. It follows from Proposition 2 since addition and product of matrices are defined as addition and product of their entries. \square

3.5 The Rational Embedding Order

Let Σ be some fixed alphabet. A finite state *transducer* is a finite state automaton whose transitions are decorated by pairs (a, w) , $a \in \Sigma$, $w \in \Sigma^*$. We refer the reader to the book of Sakarovitch [18] for details. To give the intuition, a transducer works as follows. At the beginning, the current state is set to the initial state of the transducer. The reading "head" is put on the first letter of the input and the output is set to the empty word. At each step of the computation, given some state q , some letter a read and some transition $q' \in \delta(q, (a, w))$, the transducer appends w to the output, shifts the input head to the "right" and sets the current state to q' . The computation ends when a) the input word is completely read in which case the result is the output or b) if there is no transition compatible with the current state and the read letter. In this latter case, the computation is said to fail. Thus, compared to a finite state automaton whose computations end on True (a final state) or False (not a final state) given some input word, the transducer output words, thus defining a relation in Σ^* . Given some transducer τ , if for any word, there is at most one successful computation, the transducer outputs at most one word, the relation becomes functional. In that case, we denote the function it computes by $[\tau]$.

Definition 6 (Rational Embedding Order). Given two regular languages L and L' on Σ , write $L \lesssim L'$ if:

- there is an injective function $f : L' \rightarrow L$ that is computed by a transducer τ and
- such that $|f(w)| \leq |w|$, for every $w \in L'$. Such functions (and the corresponding transducers) are said to be *decreasing* (in [22]).

The transducer τ is said to be a *witness* of $L \lesssim L'$.

We say that a transition of a transducer is *deleting* when it is of the form $a \mid 1$ for some $a \in \Sigma$. A transducer whose transitions are of the form $X \mid Y$, with $|Y| \leq |X|$, is itself decreasing. If a path corresponding to an input w passes through a deleting transition, then $|\tau(w)| < |w|$.

In the sequel we will make use of the following results that are direct consequences of Nivat's Theorem [23] (Prop. 4, §3).

Proposition 3. Let $[\tau] : L \rightarrow L'$ be computed by a transducer τ , and let L'' be a regular language. Then the following assertions hold.

1. The restriction $\tau_{L''} : L'' \cap L \rightarrow L'$ mapping $w \mapsto \tau(w)$ is computable by a transducer.
2. The co-restriction $\tau^{L''} : L \rightarrow L' \cap L''$ mapping $w \mapsto \tau(w)$ if $\tau(w) \in L''$ and otherwise undefined, is computable by a transducer.
3. The function $\tau' : L \rightarrow L'$ defined by $\tau'(w) = \tau(w)$ if $w \in L''$ and otherwise undefined, is computable by a transducer.

Observe that the identity on Σ^* is computed by a transducer (made of a unique initial/final state with transitions $a \mid a$ for all $a \in \Sigma$). Then, the identity on L is obtained by Proposition 3(1,2). Thus we have that \lesssim is reflexive. Also, it is well known that both transducers and injective functions can be composed. Hence, we also have that \lesssim is transitive. Thus, \lesssim is a preorder.

However, we do not have anti-reflexivity in general. For instance, we have

$$L_1 = A \cdot (A + B)^* \lesssim L_2 = B \cdot (A + B)^* \lesssim L_1.$$

To see this, consider the following transducer (whose initial state is indicated by an in-arrow, whereas the final one by

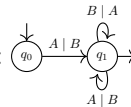
an out-arrow): . This shows that $L_1 \lesssim L_2$. Swap 'A' and 'B', to see that the reversed relation also holds.

It is worth noting that there is a simple criterion to ensure a strict inequality.

Proposition 4. Suppose $L_1 \lesssim L_2$ has a witness $\tau : L_2 \rightarrow L_1$. If τ contains one (accessible and co-accessible) deleting transition, then the relation is strict.

Proof. As before, set $L_1 < L_2$ whenever $L_1 \lesssim L_2$ but not $L_2 \lesssim L_1$. Ad absurdum, suppose $L_1 \lesssim L_2 \lesssim L_1$ with a transducer $\theta : L_1 \rightarrow L_2$ and τ as above. Then $\theta \circ \tau$ (the composition of the two transducers) defines an injective function. Let w be the smallest input word from the initial state to a final state through the transition $a \mid 1$ in τ . Define the set

$$M^{<|w|} = \{u \in L_2 \mid |u| < |w|\}.$$

For any word u , we have $|\theta \circ \tau(u)| \leq |u|$. Thus $\theta \circ \tau(M^{<w}) \subseteq M^{<w}$. Since $M^{<w}$ is a finite set and $\theta \circ \tau$ is injective, it is actually bijective when restricted to $M^{<w}$. However, $|\theta \circ \tau(w)| \leq |\tau(w)| < w$ implies $\theta \circ \tau(w) \in M^{<w}$. By the Pigeon-hole Principle, there is one word in $M^{<w}$ that has two pre-images via $\theta \circ \tau$. Thus, $\theta \circ \tau$ cannot be injective, which yields a contradiction. \square

Remark 3. From Proposition 3 it follows that if two regular languages L and L' are such that $L \subseteq L'$, then $L \lesssim L'$.

Definition 7. The rational embedding order extends to matrices by pointwise ordering: Let M and N with dimension $P \times P$, and write $M \lesssim N$ if for every $i, j \in P \times P$, we have $M_{i,j} \lesssim N_{i,j}$.

Recall the modified version of 'Follow' (Example 3). The following transducers show that all entries strictly decrease.

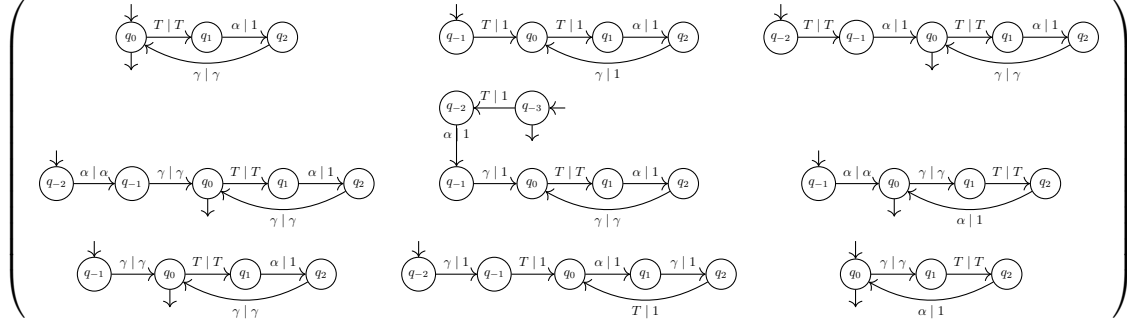

In the following, to compare two graphs by means of the rational embedding order, we transform graphs into matrices as follows. Given a graph G , let M'_G be the matrix of dimension $\mathcal{N}_G \times \mathcal{N}_G$ such that $(M'_G)_{i,j} = T_1^{i,j} + T_2^{i,j} + \dots + T_\ell^{i,j}$ with T_1, \dots, T_ℓ the labels of the edges from i to j . In other words, we “decorate” the labels with the source and target nodes. Then, $G \lesssim G'$ whenever $M'_G \lesssim M'_{G'}$.

3.6 Stable orders on matrices

A matrix on E is said to be *finite* whenever all its entries are finite. Two matrices M and M' (of same dimension) on E are said to be disjoint if for every i, j , $M_{i,j} \cdot M'_{i,j} = 0$.

Definition 8. Let M be a matrix of dimension $P \times P$ and $P \subseteq G$. The extension of M to dimension $G \times G$ is the matrix $M^{\uparrow G}$ defined by:

$$(M^{\uparrow G})_{i,j} = \begin{cases} M_{i,j} & \text{if } i, j \in P \\ 0 & \text{otherwise} \end{cases}$$

The notation $M^{\uparrow G}$ is shortened to M^\uparrow when G is clear from the context.

Fact 1. Let M be a matrix of dimension $P \times P$, with $P \subseteq G$. Then $(M^{\uparrow G})^* = (M^*)^{\uparrow G}$.

Definition 9. We say that a partial order \preceq on E is *stable by context* if for every $P \subseteq G$, all matrices L and R of dimension $P \times P$, and every C of dimension $G \times G$, the following assertions hold.

1. If L, R, C are finite, L being disjoint from C , R being disjoint from C and $R^* \prec L^*$, then $(R + C)^* \prec (L + C)^*$;
2. If $R \prec L$, then $R^{\uparrow G} \prec L^{\uparrow G}$.

Lemma 1. Let \preceq be a partial order stable by context and consider finite matrices L, R of dimension $P \times P$ and let C be a finite matrix of dimension $G \times G$ with $P \subseteq G$. Then, $R^* \prec L^*$ implies $(R^\uparrow + C)^* \prec (L^\uparrow + C)^*$.

Proof. If $R^* \prec L^*$, then we have $(R^*)^\uparrow \prec (L^*)^\uparrow$ by Definition 9.2. By Lemma 1, it follows that $(R^\uparrow)^* \prec (L^\uparrow)^*$. Clearly, R^\uparrow and L^\uparrow are finite, and from Definition 9.1, we have $(R^\uparrow + C)^* \prec (L^\uparrow + C)^*$ \square

Theorem 1. Let \preceq be a partial order stable by context. Suppose that for every rule $R = \langle P, \vec{c} \rangle$ with $P = \langle P_0, \vec{v} \rangle$ and P'_0 the self-application of R , we have $(P'_0)^* \prec (P_0)^*$. Then the corresponding GRS is terminating.

Proof. Let \preceq be a partial order on graphs and consider the corresponding order on matrices: $G \prec G'$ if and only if $M_G^* \prec M_{G'}^*$. We show that for every rule, we have $G \rightarrow G'$ implies $G' \prec G$. So let R be a graph rewriting rule and let μ be a morphism such that $G \rightarrow_{R,\mu} G'$. By the discussion in the beginning of Section 3, without loss of generality, we

can suppose that μ is actually the inclusion of pattern P_0 in G . Now, let P_0 and P'_0 be respectively the basic pattern and the self-application of R . Define C to be the graph made of the nodes of G without edges in P_0 . By Proposition 1, $M_G = M_{P_0}^\uparrow + M_C$ and $M_{G'} = M_{P'_0}^\uparrow + M_C$. Moreover, $M_{P_0}, M_{P'_0}$ and M_C are finite, M_{P_0} is disjoint from M_C , and $M_{P'_0}$ is disjoint from M_C . From Lemma 1 it thus follows that $M_{G'}^* = (M_{P'_0}^\uparrow + M_C)^* \prec (M_{P_0}^\uparrow + M_C)^* = M_G^*$. \square

3.7 Stability of the orderings

We can now prove the two announced stability results.

Proposition 5. The multiset path ordering is stable by context.

Proof. We first verify that condition 2 of Definition 9 holds. Suppose that $R \triangleleft L$ with R, L of dimension $P \times P$. Then, for all $(i, j) \notin P \times P$, $R_{i,j}^{\uparrow G} = 0 \trianglelefteq 0 = L_{i,j}^{\uparrow G}$. Now, for all $k \geq |G| \geq |P|$ and for all $(i, j) \in P \times P$, we have $(R^{\uparrow G})_{i,j}^{\leq k} = R_{i,j}^{\leq k} \trianglelefteq L_{i,j}^{\leq k} = (L^{\uparrow G})_{i,j}^{\leq k}$. To verify that condition 1 also holds, let $G \times G$ be the dimension of L, R and C . Take $k \geq |G|$. On the one side we have

$$(R + C)^{* \leq k} = \sum_{(A_1, \dots, A_\ell) \in \{R, C\}^*, \ell \leq k} \prod_{i \leq \ell} A_i$$

and on the other side

$$(L + C)^{* \leq k} = \sum_{(A_1, \dots, A_\ell) \in \{R, C\}^*, \ell \leq k} \prod_{i \leq \ell} A_i \{R \leftarrow L\},$$

where $A_i \{R \leftarrow L\} = L$ if $A_i = R$, and C otherwise. As the product and the addition are (strictly) monotonic, the result follows. \square

Proposition 6. The rational embedding order is stable by context.

Proof. Since we use a component-wise ordering, it is easy to verify that condition 2 of Definition 9 holds. To verify that condition 1 also holds, let $P \times P$ be the shared dimension of L, R and C of dimension $G \times G$ with $P \subseteq G$. Since $R < L$, there are decreasing transducers $\tau_{i,j} : L_{i,j} \rightarrow R_{i,j}$ with at least one of them deleting. We build the family of transducers $(\theta_{p,q})_{p,q \in G \times G}$ as follows. The family of transducers will share the major part of the construction. They only differ by their initial and terminal states. First, we make a copy of all transducers $(\tau_{i,j})_{i,j}$. Then, we add as states all the elements of G outside P . Given a non null entry $T = C_{i,j}$, we set a transition $i \xrightarrow{T^{i,j} | T^{i,j}} j$. That is the transducer "copies" the paths within C . For a an entry $T = C_{i,j}$ with $i \notin P, j \in P$, we set the transitions: $i \xrightarrow{T^{i,j} | T^{i,j}} q_n$ for all q_n initial state of the transducer $\tau_{j,n}, n \in P$. Similarly, for any entry $T = C_{i,j}$ with $i \in P, j \notin P$, we set the transitions: $r_n \xrightarrow{T^{i,j} | T^{i,j}} j$ for each terminal state r_n of the transducer $\tau_{n,i}, n \in P$. This construction can be represented as follows:

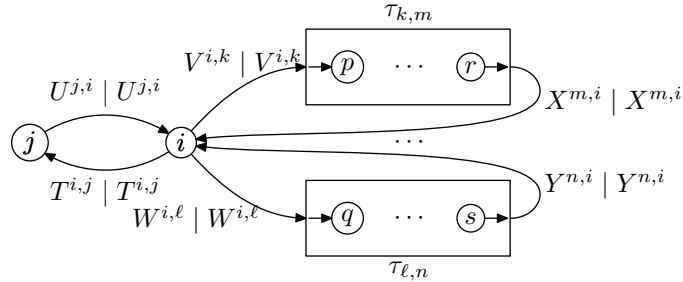

where U, T, W, X, Y range over the edge labels. Take $k, \ell \notin P$. Any path from state k to state ℓ describes a path in $C + L$ on the input side and a path in $C + R$ on the output side. Indeed, transitions within C are simply copied and the transducers $\tau_{i,j}$ transform paths in L into paths in R .

It remains to specify initial and final states of $\theta_{p,q}$ with $(p, q) \in G \times G$. Given some entry $p, q \in G$, if $p \notin P$, we set the initial state to be p . Otherwise, we introduce a new state ι which is set to be initial, and we add a transition $\iota \xrightarrow{1|1} i$ for any state i initial in $\tau_{p,r}$ for some r . If $q \notin P$, then, q is the final state. Otherwise, any state j within some $\tau_{r,q}, r \in P$, is final.

Consider some pair $p, q \in G$. We prove that the transducer $\theta_{p,q}$ is injective. Consider a path w in $C + L$. It can be decomposed as follows: $w = w_1 \ell_1 \cdots w_k \ell_k$ where the ℓ_i 's are the sub-words within L (that is the w_i 's have the shape $v_i a_i$ where a_i is a transition from C to L). Consider a second word $w' = w'_1 \ell'_1 \cdots w'_{k'} \ell'_{k'}$ such that the transducer $\theta_{p,q}(w) = \theta_{p,q}(w') = u$. Given the construction of $\theta_{p,q}$, consider the word $u = u_1 r_1 \cdots u_k r_k$ with r_1, \dots, r_k some path within R . Indeed, only a letter within L can produce a letter within R . Consider the case where r_k is non empty. When the transducer reaches the first letter in ℓ_k , it is in a state $\tau_{k,m}$ for some m . Actually, $m = q$ since only $\tau_{k,q}$ contains a final state. Thus, the path is fixed within $\tau_{k,p}$ and then the injectivity of $\tau_{k,p}$ applies. So, $\ell'_{k'} = \ell_k$. We can go back within w_k . On this part of the word, the transitions have the shape $T^{i,j} \mid T^{i,j}$. Thus, $w_k = w'_{k'}$. We can continue this process up to the beginning of w and w' . \square

3.8 Termination with node creation

Up to here, rewriting did not involve node creation. In this subsection, we will address this issue informally, and we leave for future work the definitive formalization.

So consider a new command `add_node(α)` with α a label. This command adds a new node to the graph with label α . As in standard settings, this node is not related to others at creation time.

Actually, we see node creation as follows. Let us consider a fixed denumerable set U of nodes. For any finite graph, one may suppose without loss of generality that its nodes belong to U . More precisely, we see graphs as having \bar{U} as an underlying node set, among which only finitely many are “under focus”. The nodes in this finite set have a label within the set Σ_N and they may be related via edges to some other nodes, all the others are isolated and their label is \perp , a trash label. In other words, there is never some node creation, but some may be added to the focus. Notice that at each step, only finitely many nodes may be added to a graph via rewriting. In finitely many steps, starting from a finite graph, the denumerable set U is a sufficiently large container.

If we come back to our termination issue, there are a few changes. In the one hand, matrices have infinite dimension, that is, $U \times U$. But on the other hand, at each step of computation, only finitely many entries are non null. Thus, all established results still apply to this more general framework and the method is still correct.

As a consequence, if we still find some ordering on language matrices, termination will follow. However, there is one important point that must be discussed in detail. We said that the ordering on matrices did not need to be well founded to show termination. And for that, we needed the fact that all graphs met during computation have a fixed size (so that there are only finitely many of them). In the present context, this hypothesis is not reasonable in general. We thus propose two ways of overcoming this apparent limitation.

First, if the ordering on matrices is well-founded, there are no more issues. Termination will hold directly. Second, if the ordering is not well-founded, then we will need an additional ingredient. Let us suppose that the ordering \prec is stable by edge contraction: that is, if G' is obtained from G by contracting some edge $e \in G$, then $M_{G'} \prec M_G$. Suppose furthermore that for any steps, $G \rightarrow G'$, we have $M_{G'} \prec M_G$, then the system is terminating. Indeed, due to Robertson and Seymour's Theorem (see [24],), any infinite sequence $M_{G_1} \succ M_{G_2} \succ \cdots$ will contain two indices for which M_{G_j} is a (directed) minor of M_{G_k} for some $j < k$. That is G_j is obtained from G_k by finitely many edge contractions. But, since the order is stable by edge contraction, then, $M_{G_j} \prec M_{G_k}$ which leads to the contradiction. Thus, the result.

The notion of minors for the directed case may be discussed further, see for instance [25]. We leave that exploration for some other day.

4 Interpretations for Graph Rewriting Termination

Interpretation methods are well known in the context of term rewriting, see for instance Dershowitz and Jouannaud's survey on rewriting [13]. Their usefulness comes from the fact that they belong to the class of simplification orderings, i.e., orderings for which if $t \preceq u$, then $t \preceq u$. In the context of graphs, we introduce a specific notion of “interpretation”, that we will still call interpretation.

Definition 10. A graph *interpretation* is a triple $\langle X, \prec, \phi \rangle$ where $\langle X, \prec \rangle$ is a partially ordered set and $\phi : \mathcal{G} \rightarrow X$ is such that given two graphs P and P' having the same set of nodes and C disjoint of P and P' , if $\phi(P) \prec \phi(P')$, then $\phi(P + C) \prec \phi(P' + C)$.

An interpretation $\Omega = \langle X, \prec, \phi \rangle$ is *compatible* with a rule R if $\phi(P'_0) \prec \phi(P_0)$ where P_0 is the basic pattern of R and P'_0 its self-application. Similarly, an interpretation is compatible with a GRS if it is compatible with all of its rules.

Theorem 2. Every GRS compatible with an interpretation Ω is terminating.

The theorem being a more abstract form of Theorem 1, its proof follows exactly the same steps.

Proof. Suppose that $G \prec G'$ if and only if $\phi(G) \prec \phi(G')$. We prove that for each rule R of the GRS, $G \rightarrow G'$ implies $G' \prec G$. Indeed, suppose that $G \rightarrow_{R,\mu} G'$. Let P_0 and P'_0 be respectively the basic pattern and the self-application of R . Then, there is a graph C such that $G = P_0 + C$, $G' = P'_0 + C$, such that P_0 and P'_0 are disjoint from C . Since $\phi(P'_0) \prec \phi(P_0)$, we then have $\phi(G') \prec \phi(G)$. \square

Example 4. The triple $\langle \mathfrak{M}, \preceq, (M_{(-)})^* \rangle$ is an interpretation for 'Follow'.

Example 5. Let us come back to the weight analysis. Define $\bar{\omega}(G) = \sum_{p \rightarrow q \in G} \omega(e)$ with $\omega(\alpha) = 0, \omega(T) = -1, \omega(\beta) = -1$. Then, $\langle \mathbb{R}, <, \bar{\omega}(-) \rangle$ is an interpretation for 'Init' and 'End'.

Example 6. Let $\langle X_1, \prec_1, \phi_1 \rangle$ be an interpretation for a set of rules \mathcal{R}_1 , and let $\langle X_2, \prec_2, \phi_2 \rangle$ be an interpretation for a set of rules \mathcal{R}_2 . Suppose that for every rule R in \mathcal{R}_2 , $G \rightarrow_{R,\mu} G'$ implies $G' \preceq_1 G$ (that is without strict inequality). Then the lexicographic ordering on $X_1 \times X_2$ defined by $(x_1, x_2) \prec_{1,2} (y_1, y_2)$ if and only if $x_1 \prec_1 y_1$, or $x_1 \preceq_1 y_1$ and $x_2 \prec_2 y_2$, constitutes an interpretation $\langle X_1 \times X_2, \prec_{1,2}, \phi_1 \times \phi_2 \rangle$ for $\mathcal{R}_1 \cup \mathcal{R}_2$.

Thus, combining Example 4 and Example 5, we have a proof of the termination of the Main Example (Subsection 2.1).

Corollary 2. The GRS given in Subsection 2.1 is terminating.

Example 7. Let \mathcal{R} be a terminating GRS. Then there is an interpretation that "justifies" this fact. Indeed, take $\langle \mathcal{G}, \prec, 1_{\mathcal{G}} \rangle$ with \prec defined to be the transitive closure of the rewriting relation \rightarrow . The termination property ensures that the closure leads to an irreflexive relation. The compatibility of \prec with respect to $1_{\mathcal{G}}$ is immediate.

We thus have the following corollary.

Corollary 3. A GRS is terminating if and only if it is compatible with some interpretation.

5 Conclusion

We proposed a new approach based on the theory of regular languages to decide the termination of graph rewriting systems, which does not account for node additions but settles the uniform termination problem for these GRS. We think that there is room to reconsider some old results of this theory under the new light. In particular, we think of profinite topology [26], is a powerful tool that could give us some insight on the underlying structure of the orders. In the two cases, we can extend the orders to take into account orders on the edge labels.

As the next natural step, we intend to explore more systematically graph rewriting with node creations and that take into account node labels. Moreover, in the experiments mentioned in the introduction about natural language processing, in principle, these two orders should still be sufficient to ensure termination. However, we need to implement these new results for an extensive and complete evaluation.

Acknowledgment. The authors are thankful to the anonymous reviewers for their careful reading of our manuscript and for the constructive remarks and useful suggestions, that were of great help when revising this manuscript.

References

- [1] Noam Chomsky. *Syntactic Structures*. The Hague: Mouton, 1957.
- [2] Bruno Guillaume and Guy Perrier. Dependency parsing with graph rewriting. In *Proceedings of the 14th International Conference on Parsing Technologies, IWPT 2015, Bilbao, Spain, July 5-7, 2015*, pages 30–39, 2015.
- [3] Sylvain Kahane and François Lareau. Word ordering as a graph rewriting process. In *Formal Grammar - 20th and 21st International Conferences, FG 2015, Barcelona, Spain, August 2015, Revised Selected Papers. FG 2016, Bozen, Italy, August 2016, Proceedings*, volume 9804, pages 216–239. Springer, 2016.
- [4] Guillaume Bonfante, Bruno Guillaume, and Guy Perrier. *Application of Graph Rewriting to Natural Language Processing*. Logic, Linguistic and Computer Science. Wiley, 2018.
- [5] Grzegorz Rozenberg, editor. *Handbook of Graph Grammars and Computing by Graph Transformation: Volume I. Foundations*. World Scientific Publishing Co., Inc., River Edge, NJ, USA, 1997.
- [6] Bruno Courcelle and Joost Engelfriet. *Graph Structure and Monadic Second-Order Logic*. Cambridge University Press, 2012.
- [7] Mizuhito Ogawa. A note on algebraic structure of tree decomposition of graphs. In *The First Asian Workshop on Programming Languages and Systems, APLAS 2000, National University of Singapore, Singapore, December 18-20, 2000, Proceedings*, pages 223–229, 2000.

- [8] Yves Lafont. Interaction nets. In *Conference Record of the Seventeenth Annual ACM Symposium on Principles of Programming Languages, San Francisco, California, USA, January 1990*, pages 95–108, 1990.
- [9] Maribel Fernández, Hélène Kirchner, and Bruno Pinaud. Strategic port graph rewriting: an interactive modelling framework. *Mathematical Structures in Computer Science*, 29(5):615–662, 2019.
- [10] Nachum Dershowitz and Jean-Pierre Jouannaud. Drags: A compositional algebraic framework for graph rewriting. *Theor. Comput. Sci.*, 777:204–231, 2019.
- [11] Gérard Sénizergues. Some undecidable termination problems for semi-Thue systems. *Theoretical Computer Science*, 142:257–276, 1995.
- [12] Guillaume Bonfante and Bruno Guillaume. Non-simplifying graph rewriting termination. In *Proceedings 7th International Workshop on Computing with Terms and Graphs, TERMGRAPH 2013, Rome, Italy, 23th March 2013*, pages 4–16, 2013.
- [13] Nachum Dershowitz and Jean-Pierre Jouannaud. Rewrite systems. In *Handbook of Theoretical Computer Science, Volume B: Formal Models and Semantics*, pages 243–320. 1990.
- [14] Nachum Dershowitz and Jean-Pierre Jouannaud. Graph path orderings. In *LPAR-22. 22nd International Conference on Logic for Programming, Artificial Intelligence and Reasoning, Awassa, Ethiopia, 16-21 November 2018*, pages 307–325, 2018.
- [15] Detlef Plump. Simplification orders for term graph rewriting. In Igor Prívvara and Peter Ružička, editors, *Mathematical Foundations of Computer Science 1997*, pages 458–467, Berlin, Heidelberg, 1997. Springer Berlin Heidelberg.
- [16] Jörg Endrullis, Johannes Waldmann, and Hans Zantema. Matrix interpretations for proving termination of term rewriting. *Journal of Automated Reasoning*, 40(2):195–220, Mar 2008.
- [17] Nachum Dershowitz. A note on simplification orderings. *Information Processing Letters*, pages 212–215, 1979.
- [18] Jacques Sakarovitch. *Elements of Automata Theory*. Cambridge University Press, 2009.
- [19] Jan Rutten. Behavioural differential equations: a coinductive calculus of streams, automata, and power series. *Theoretical Computer Science*, 308(1):1 – 53, 2003.
- [20] Nachum Dershowitz and Zohar Manna. Proving termination with multiset orderings. *Commun. ACM*, 22(8), 1979.
- [21] Gerard Huet and Derek C. Oppen. Equations and rewrite rules: a survey. In *In formal language Theory: perspective and open problems*. Academic Press, 1980.
- [22] Jeannine Leguy. Transductions rationnelles décroissantes. *RAIRO. Informatique théorique*, 15(2):141–148, 1981.
- [23] Maurice Nivat. Transducteurs des langages de Chomsky. *Ann. Inst. Fourier, Grenoble*, 18:339–455, 1968.
- [24] Neil Robertson and Paul D. Seymour. Graph minors. XX. Wagner’s conjecture. *J. Comb. Theory, Ser. B*, 92(2):325–357, 2004.
- [25] Shiva Kintali and Qiuyi Zhang. Forbidden directed minors and Kelly-width. *Theoretical Computer Science*, 662:40 – 47, 2017.
- [26] Jean-Eric Pin. Profinite methods in automata theory. In *26th International Symposium on Theoretical Aspects of Computer Science, STACS 2009, February 26-28, 2009, Freiburg, Germany, Proceedings*, volume 3 of *LIPICs*, pages 31–50. Schloss Dagstuhl - Leibniz-Zentrum fuer Informatik, Germany, 2009.

INVERSION NUMBER OF AN ORIENTED GRAPH AND RELATED PARAMETERS

Jørgen Bang-Jensen

Department of Mathematics and Computer Science,
University of Southern Denmark
Odense, Denmark
jbj@imada.sdu.dk

Jonas Costa Ferreira da Silva

Department of Computer Science
Universidade Federal do Ceará
Fortaleza, Brazil
jonascosta@lia.ufc.br

Frédéric Havet

Université Côte d'Azur, CNRS, Inria, I3S,
Sophia Antipolis, France
frederic.havet@inria.fr

ABSTRACT

Let D be an oriented graph. The **inversion** of a set X of vertices in D consists in reversing the direction of all arcs with both ends in X . The **inversion number** of D , denoted by $\text{inv}(D)$, is the minimum number of inversions needed to make D acyclic. Denoting by $\tau(D)$, $\tau'(D)$, and $\nu(D)$ the cycle transversal number, the cycle arc-transversal number and the cycle packing number of D respectively, one shows that $\text{inv}(D) \leq \tau'(D)$, $\text{inv}(D) \leq 2\tau(D)$ and there exists a function g such that $\text{inv}(D) \leq g(\nu(D))$. We conjecture that for any two oriented graphs L and R , $\text{inv}(L \rightarrow R) = \text{inv}(L) + \text{inv}(R)$ where $L \rightarrow R$ is the dijoin of L and R . This would imply that the first two inequalities are tight. We prove this conjecture when $\text{inv}(L) \leq 1$ and $\text{inv}(R) \leq 2$ and when $\text{inv}(L) = \text{inv}(R) = 2$ and L and R are strongly connected. We also show that the function g of the third inequality satisfies $g(1) \leq 4$.

We then consider the complexity of deciding whether $\text{inv}(D) \leq k$ for a given oriented graph D . We show that it is NP-complete for $k = 1$, which together with the above conjecture would imply that it is NP-complete for every k . This contrasts with a result of Belkhechine et al. [6] which states that deciding whether $\text{inv}(T) \leq k$ for a given tournament T is polynomial-time solvable.

Keywords Feedback vertex set · Feedback arc set · Inversion · Tournament · Oriented graph · Intercyclic digraph.

1 Introduction

Notation not given below is consistent with [2]. Making a digraph acyclic by either removing a minimum cardinality set of arcs or vertices are important and heavily studied problems, known under the names **CYCLE ARC TRANSVERSAL** or **FEEDBACK ARC SET** and **CYCLE TRANSVERSAL** or **FEEDBACK VERTEX SET**. A **cycle transversal** or **feedback vertex set** (resp. **cycle arc-transversal** or **feedback arc set**) in a digraph is a set of vertices (resp. arcs) whose deletion results in an acyclic digraph. The **cycle transversal number** (resp. **cycle arc-transversal number**) is the minimum size of a cycle transversal (resp. cycle arc-transversal) of D and is denoted by $\tau(D)$ (resp. $\tau'(D)$). Note that if F is a minimum cycle arc-transversal in a digraph $D = (V, A)$, then we will obtain an acyclic digraph from D by either removing the arcs of F or reversing each of these, that is replacing each arc $uv \in F$ by the arc vu . It is well-known and easy to show that $\tau(D) \leq \tau'(D)$ (just take one end-vertex of each arc in a minimum cycle arc-transversal).

Computing $\tau(D)$ and $\tau'(D)$ are two of the first problems shown to be NP-hard listed by Karp in [9]. They also remains NP-complete in tournaments as shown by Bang-Jensen and Thomassen [4] and Speckenmeyer [14] for τ , and by Alon [1] and Charbit, Thomassé, and Yeó [7].

In this paper, we consider another operation, called **inversion**, where we reverse all arcs of an induced subdigraph. Let D be a digraph. The **inversion** of a set X of vertices consists in reversing the direction of all arcs of $D[X]$. We say that we **invert** X in D . The resulting digraph is denoted by $\text{Inv}(D; X)$. If $(X_i)_{i \in I}$ is a family of subsets of $V(D)$, then $\text{Inv}(D; (X_i)_{i \in I})$ is the digraph obtained after inverting the X_i one after another. Observe that this is independent of the order in which we invert the X_i : $\text{Inv}(D; (X_i)_{i \in I})$ is obtained from D by reversing the arcs such that an odd number of the X_i contain its two end-vertices.

Since an inversion preserves the directed cycles of length 2, a digraph can be made acyclic only if it has no directed cycle of length 2, that is if it is an **oriented graph**. Reciprocally, observe that in an oriented graph, reversing an arc $a = uv$ is the same as inverting $X_a = \{u, v\}$. Hence if F is a cycle arc-transversal of D , then $\text{Inv}(D; (X_a)_{a \in F})$ is acyclic.

A **decycling family** of an oriented graph D is a family of subsets $(X_i)_{i \in I}$ of subsets of $V(D)$ such that $\text{Inv}(D; (X_i)_{i \in I})$ is acyclic. The **inversion number** of an oriented graph D , denoted by $\text{inv}(D)$, is the minimum number of inversions needed to transform D into an acyclic digraph, that is, the minimum cardinality of a decycling family. By convention, the empty digraph (no vertices) is acyclic and so has inversion number 0.

1.1 Inversion versus cycle (arc-) transversal and cycle packing

One can easily obtain the following upper bounds on the inversion number in terms of the cycle transversal number and the cycle arc-transversal number. See Section 2.

Theorem 1.1. $\text{inv}(D) \leq \tau'(D)$ and $\text{inv}(D) \leq 2\tau(D)$ for all oriented graph D .

A natural question is to ask whether these bounds are tight or not.

We denote by \vec{C}_3 the directed cycle of length 3 and by TT_n the transitive tournament of order n . The vertices of TT_n are v_1, \dots, v_n and its arcs $\{v_i v_j \mid i < j\}$. The **lexicographic product** of a digraph D by a digraph H is the digraph $D[H]$ with vertex set $V(D) \times V(H)$ and arc set $A(D[H]) = \{(a, x)(b, y) \mid ab \in A(D), \text{ or } a = b \text{ and } xy \in A(H)\}$. It can be seen as blowing up each vertex of D by a copy of H . Using boolean dimension, Belkhechine et al. [5] proved the following.

Theorem 1.2 (Belkhechine et al. [5]). $\text{inv}(TT_n[\vec{C}_3]) = n$.

Since $\tau'(TT_n[\vec{C}_3]) = n$, this shows that the inequality $\text{inv}(D) \leq \tau'(D)$ of Theorem 1.1 is tight.

Pouzet asked for an elementary proof of Theorem 1.2. Let L and R be two digraphs. The **dijoin** from L to R is the digraph, denoted by $L \rightarrow R$, obtained from the disjoint union of L and R by adding all arcs from L to R . Observe that $TT_n[\vec{C}_3] = \vec{C}_3 \rightarrow TT_{n-1}[\vec{C}_3]$. So a way to elementary prove Theorem 1.2 would be to prove that $\text{inv}(\vec{C}_3 \rightarrow T) = \text{inv}(T) + 1$ for all tournament T . In fact, we believe that the following more general statement holds.

Conjecture 1.3. For any two oriented graphs L and R , $\text{inv}(L \rightarrow R) = \text{inv}(L) + \text{inv}(R)$.

As observed in Proposition 2.5, this conjecture is equivalent to its restriction to tournaments. If $\text{inv}(L) = 0$ (resp. $\text{inv}(R) = 0$), then Conjecture 1.3 holds has any decycling family of R (resp. L) is also a decycling family of $L \rightarrow R$. In Section 3, we prove Conjecture 1.3 when $\text{inv}(L) = 1$ and $\text{inv}(R) \in \{1, 2\}$. We also prove it when $\text{inv}(L) = \text{inv}(R) = 2$ and both L and R are strongly connected.

Let us now consider the inequality $\text{inv}(D) \leq 2\tau(D)$ of Theorem 1.1. One can see that is tight for $\tau(D) = 1$, that is $h(1) = 2$. Indeed, let V_n be the tournament obtained from a TT_{n-1} by adding a vertex x such that $N^+(v_i) = \{v_i \mid i \text{ is odd}\}$ (and so $N^-(v_i) = \{v_i \mid i \text{ is even}\}$). Clearly, $\tau(V_n) = 1$ because $V_n - x$ is acyclic, and one can easily check that $\text{inv}(V_n) \geq 2$ for $n \geq 5$. Observe that V_5 is strong, so by the above results, we have $\text{inv}(V_5 \rightarrow V_5) = 4$ while $\tau(V_5 \rightarrow V_5) = 2$, so $h(2) = 4$. More generally, Conjecture 1.3 would imply that $\text{inv}(TT_n[V_5]) = 2n$, while $\tau(TT_n[V_5])$ and thus that the inequality (ii) of Theorem 1.1 is tight. Hence we conjecture the following.

Conjecture 1.4. $h(n) = 2n$ for all positive integer n . In other words, for every positive integer n , there exists a digraph D such that $\tau(D) = n$ and $\text{inv}(D) = 2n$.

A **cycle packing** in a digraph is a set of vertex disjoint cycles. The **cycle packing number** of a digraph D , denoted by $\nu(D)$, is the maximum size of a cycle packing in D . We have $\nu(D) \leq \tau(D)$ for every digraph D . On the other hand, Reed et al. [12] proved that there is a (minimum) function f such that $\tau(D) \leq f(\nu(D))$ for every digraph D . With Theorem 1.1 (ii), this implies $\text{inv}(D) \leq f(\nu(D))$.

Theorem 1.5. *There is a (minimum) function g such that $\text{inv}(D) \leq g(\nu(D))$ for all oriented graph D and $g \leq 2f$.*

A natural question is then to determine this function g or at least obtain good upper bounds on it. Note that the upper bound on f given by Reed et al. [12] proof is huge (a multiply iterated exponential, where the number of iterations is also a multiply iterated exponential). The only known value has been established by McCuaig [10] who proved $f(1) = 3$. As noted in [12], the best lower bound on f due to Alon (unpublished) is $f(k) \geq k \log k$. It might be that $f(k) = O(k \log k)$. This would imply the following conjecture.

Conjecture 1.6. For all k , $g(k) = O(k \log k)$: there is an absolute constant C such that $\text{inv}(D) \leq C \cdot \nu(D) \log(\nu(D))$ for all oriented graph D .

Note that for planar digraphs, combining results of Reed and Sheperd [13] and Goemans and Williamson [8], we get $\tau(D) \leq 63 \cdot \nu(D)$ for every planar digraph D . This implies that $\tau(D) \leq 126 \cdot \nu(D)$ for every planar digraph D and so Conjecture 1.6 holds for planar oriented graphs.

Another natural question is whether or not the inequality $g \leq 2f$ is tight. In Section 4, we show that it is not the case. We show that $g(1) \leq 4$, while $f(1) = 3$ as shown by McCuaig [10]. However we do not know if this bound 4 on $g(1)$ is attained. Furthermore can we characterize the intercylic digraphs with small inversion number ?

Problem 1.7. For any $k \in [4]$, can we characterize the intercylic oriented graphs with inversion number k ?

In contrast to Theorem 1.1 and 1.5, the difference between inv and ν , τ , and τ' can be arbitrarily large as for every k , there are tournaments T_k for which $\text{inv}(T_k) = 1$ and $\nu(T_k) = k$. Consider for example the tournament T_k obtained from three transitive tournaments A, B, C of order k by adding all arc from A to B , B to C and C to A . One easily sees that $\nu(T_k) = k$ and so $\tau'(T_k) \geq \tau(T_k) \geq k$; moreover $\text{Inv}(T_k; A \cup B)$ is a transitive tournament, so $\text{inv}(T_k) = 1$.

1.2 Complexity of computing the inversion number

We also consider the complexity of computing the inversion number of an oriented graph and the following associated problem.

k-INVERSION.

Input: An oriented graph D .

Question: $\text{inv}(D) \leq k$?

We also study the complexity of the restriction of this problem to tournaments.

k-TOURNAMENT-INVERSION.

Input: A tournament.

Question: $\text{inv}(T) \leq k$?

Note that 0-INVERSION is equivalent to deciding whether an oriented graph D is acyclic. This can be done in $O(|V(D)|^2)$ time.

Let k be a positive integer. A tournament T is ***k*-inversion-critical** if $\text{inv}(T) = k$ and $\text{inv}(T - x) = k - 1$ for all $x \in V(T)$. We denote by \mathcal{IC}_k the set of *k*-inversion-critical tournaments. Observe that a tournament T has inversion number at least k if and only if T has a subtournament in \mathcal{IC}_k .

Theorem 1.8 (Belkhechine et al. [6]). *For any positive integer k , the set \mathcal{IC}_k is finite.*

Checking whether the given tournament T contains I for every element I in \mathcal{IC}_{k+1} , one can decide whether $\text{inv}(T) \geq k$ in $O(|V(T)|^{m_{k+1}})$ time, where m_{k+1} be maximum order of an element of \mathcal{IC}_{k+1} .

Corollary 1.9. *For any non-negative integer k , *k*-TOURNAMENT-INVERSION is polynomial-time solvable.*

The proof of Theorem 1.8 neither explicitly describes \mathcal{IC}_k nor gives upper bound on m_k . So the degree of the polynomial in Corollary 1.9 is unknown. This leaves open the following questions.

Problem 1.10. Explicitly describe \mathcal{IC}_k or at least find an upper bound on m_k .

What is the minimum real number r_k such that *k*-TOURNAMENT-INVERSION can be solved in $O(|V(T)|^{r_k})$ time ?

As observed in [6], $\mathcal{IC}_1 = \{\vec{C}_3\}$, so $m_1 = 3$. This implies that 0-TOURNAMENT-INVERSION can be done in $O(n^3)$. However, deciding whether a tournament is acyclic can be solved in $O(n^2)$ -time. Belkhechine et al. [6] also proved that $\mathcal{IC}_2 = \{A_6, B_6, D_5, T_5, V_5\}$ where $A_6 = TT_2(\vec{C}_3) = \text{Inv}(TT_6; (\{v_1, v_3\}, \{v_4, v_6\}))$, $B_6 = \text{Inv}(TT_6; (\{v_1, v_4, v_5\}, \{v_2, v_5, v_6\}))$, $D_5 = \text{Inv}(TT_5; (\{v_2, v_4\}, \{v_1, v_5\}))$, $R_5 = \text{Inv}(TT_5; (\{v_1, v_3, v_5\}, \{v_2, v_4\}))$, and $V_5 = \text{Inv}(TT_5; (\{v_1, v_5\}, \{v_3, v_5\}))$. See Figure 1.

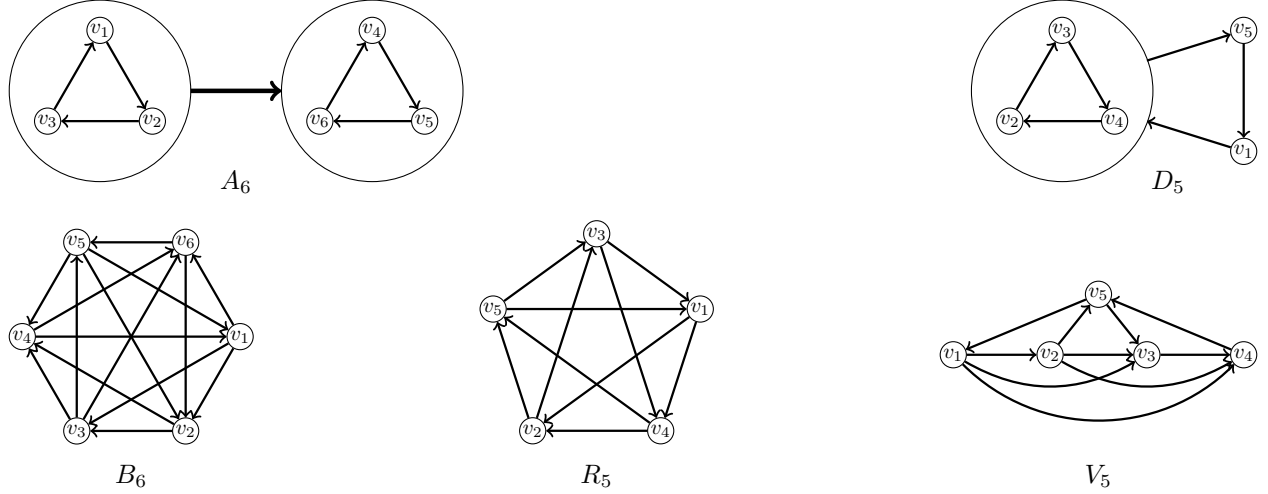

Figure 1: The 2-inversion-critical tournaments

Hence $m_2 = 6$, so 1-TOURNAMENT-INVERSION can be solved in $O(n^6)$ -time. This is not optimal: we show in Subsection 5.2 that it can be solved in $O(n^3)$ -time, and that 2-TOURNAMENT-INVERSION can be solved in $O(n^6)$ -time.

There is no upper bound on m_k so far. Hence since the inversion number of a tournament can be linear in its order (See e.g. tournament T_k described at the end of the introduction), Theorem 1.8 does not imply that one can compute the inversion number of a tournament in polynomial time. In fact, we believe that it is not.

Conjecture 1.11. Given a tournament and an integer k , deciding whether $\text{inv}(T) = k$ is NP-complete.

In contrast to Corollary 1.9, we show in Subsection 5.1 that 1-INVERSION is NP-complete. Note that together with Conjecture 1.3, this would imply that k -INVERSION is NP-complete for every positive integer k .

Conjecture 1.12. k -INVERSION is NP-complete for all positive integer k .

As we proved Conjecture 1.3. when $\text{inv}(L) = \text{inv}(R) = 1$, we get that 2-INVERSION is NP-complete.

Because of its relations with τ' , τ , and ν , (see Subsection 1.1), it is natural to ask about the complexity of computing the inversion number when restricted to oriented graphs (tournaments) for which one of these parameters is bounded. Recall that $\text{inv}(D) = 0$ if and only if D is acyclic, so if and only if $\tau'(D) = \tau(D) = \nu(D) = 0$.

Problem 1.13. Let k be a positive integer and γ be a parameter in $\{\tau', \tau, \nu\}$. What is the complexity of computing the inversion number of an oriented graph (tournament) D with $\gamma(D) \leq k$?

Conversely, it is also natural to ask about the complexity of computing any of τ' , τ , and ν , when restricted to oriented graphs with bounded inversion number. In Subsection 5.3, we show that computing any of these parameters is NP-hard even for oriented graphs with inversion number 1. However, the question remains open when we restrict to tournaments.

Problem 1.14. Let k be a positive integer and γ be a parameter in $\{\tau', \tau, \nu\}$. What is the complexity of computing $\gamma(T)$ for a tournament D with $\text{inv}(T) \leq k$?

2 Properties of the inversion number

In this section, we establish easy properties of the inversion number and deduce from them Theorem 1.1 and the fact that Conjecture 1.3 is equivalent to its restriction to tournaments.

The inversion number is monotone :

Proposition 2.1. If D' is a subdigraph of an oriented graph D , then $\text{inv}(D') \leq \text{inv}(D)$.

Proof. Let D' be a subdigraph of D . If $(X_i)_{i \in I}$ is a decycling family of D , then $(X_i \cap V(D'))_{i \in I}$ is a decycling family of D' . \square

Lemma 2.2. *Let D be a digraph. If D a source (a sink) x , then $\text{inv}(D) = \text{inv}(D - x)$.*

Proof. Every decycling family of $D - x$ is also a decycling family of D since adding a source (sink) to an acyclic digraph results in an acyclic digraph. \square

Lemma 2.3. *Let D be an oriented graph and let x be a vertex of D . Then $\text{inv}(D) \leq \text{inv}(D - x) + 2$.*

Proof. Let $N^+[x]$ be the closed out-neighbourhood of x , that is $\{x\} \cup N^+(x)$. Observe that $D' = \text{Inv}(D; (N^+[x], N^+(x)))$ is the oriented graph obtained from D by reversing the arc between x and its out-neighbours. Hence x is a sink in D' and $D' - x = D - x$. Thus, by Lemma 2.2, $\text{inv}(D) \leq \text{inv}(D') + 2 \leq \text{inv}(D - x) + 2$. \square

Proof of Theorem 1.1. As observed in the introduction, if F is a feedback arc-set, then the family of sets of end-vertices of arcs of F is a decycling family. So $\text{inv}(D) \leq \tau'(D)$.

Let $S = \{x_1, \dots, x_k\}$ be a cycle transversal with $k = \tau(D)$. Lemma 2.3 and a direct induction imply $\text{inv}(D) \leq \text{inv}(D - \{x_1, \dots, x_i\}) + 2i$ for all $i \in [k]$. Hence $\text{inv}(D) \leq \text{inv}(D - S) + 2k$. But, since S is a cycle transversal, $D - S$ is acyclic, so $\text{inv}(D - S) = 0$. Hence $\text{inv}(D) \leq 2k = 2\tau(D)$. \square

Let D be an oriented graph. An **extension** of D is a tournament T such that $V(D) = V(T)$ and $A(D) \subseteq A(T)$.

Lemma 2.4. *Let D be an oriented graph. There is an extension T of D such that $\text{inv}(T) = \text{inv}(D)$.*

Proof. Set $p = \text{inv}(D)$ and let $(X_i)_{i \in [p]}$ be a decycling family of D . Then $D^* = \text{Inv}(D; (X_i)_{i \in [p]})$ is acyclic and so admits an acyclic ordering (v_1, \dots, v_n) .

Let T be the extension of D constructed as follows: For every $1 \leq i < j \leq p$ such that $v_i v_j \notin A(D^*)$, let $n(i, j)$ be the number of $X_i, i \in [p]$, such that $\{v_i, v_j\} \subseteq X_i$. If $n(i, j)$ is even then the arc $v_i v_j$ is added to $A(T)$, and if $n(i, j)$ is odd then the arc $v_j v_i$ is added to $A(T)$. Note that in the first case, $v_i v_j$ is reversed an even number of times by $(X_i)_{i \in [p]}$, and in the second $v_j v_i$ is reversed an odd number of times by $(X_i)_{i \in [p]}$. Thus, in both cases, $v_i v_j \in \text{Inv}(T; (X_i)_{i \in [p]})$. Consequently, (v_1, \dots, v_n) is also an acyclic ordering of $\text{Inv}(T; (X_i)_{i \in [p]})$. Hence $\text{inv}(T) \leq \text{inv}(D)$, and so, by Proposition 2.1, $\text{inv}(T) = \text{inv}(D)$. \square

Proposition 2.5. *Conjecture 1.3 is equivalent to its restriction to tournaments.*

Proof. Suppose there are oriented graphs L, R that form a counterexample to Conjecture 1.3, that is such that $\text{inv}(L \rightarrow R) < \text{inv}(L) + \text{inv}(R)$. By Lemma 2.4, there is an extension T of $L \rightarrow R$ such that $\text{inv}(T) = \text{inv}(L \rightarrow R)$ and let $T_L = T \langle V(L) \rangle$ and $T_R = T \langle V(R) \rangle$. We have $T = T_L \rightarrow T_R$ and by Proposition 2.1, $\text{inv}(L) \leq \text{inv}(T_L)$ and $\text{inv}(R) \leq \text{inv}(T_R)$. Hence $\text{inv}(T) < \text{inv}(T_L) + \text{inv}(T_R)$, so T_L and T_R are two tournaments that form a counterexample to Conjecture 1.3. \square

3 Inversion number of dijoins of oriented graphs

Proposition 3.1. $\text{inv}(L \rightarrow R) \leq \text{inv}(L) + \text{inv}(R)$.

Proof. First invert $\text{inv}(L)$ subsets of $V(L)$ to make L acyclic, and then invert $\text{inv}(R)$ subsets of $V(R)$ to make R acyclic. This makes $L \rightarrow R$ acyclic. \square

Proposition 3.2. *If $\text{inv}(L), \text{inv}(R) \geq 1$, then $\text{inv}(L \rightarrow R) \geq 2$.*

Proof. Assume $\text{inv}(L), \text{inv}(R) \geq 1$. Then L and R are not acyclic, so let C_L and C_R be directed cycles in L and R respectively. Assume for a contradiction that there is a set X such that inverting X in $L \rightarrow R$ results in a acyclic digraph D' . There must be an arc xy in $A(C_L)$ such that $x \in X$ and $y \notin X$, and there must be $z \in X \cap V(C_R)$. But then (x, y, z, x) is a directed cycle in D' , a contradiction. \square

Further than Proposition 3.2, the following result give some property of a minimum decycling family of $L \rightarrow R$ when $\text{inv}(L) = \text{inv}(R) = 1$.

Theorem 3.3. *Let $D = (L \rightarrow R)$, where L and R are two oriented graphs with $\text{inv}(L) = \text{inv}(R) = 1$. Then, for any decycling family (X_1, X_2) of D , either $X_1 \subset V(L), X_2 \subset V(R)$ or $X_1 \subset V(L), X_2 \subset V(R)$.*

Proof. Let (X_1, X_2) be a decycling family of D and let D^* be the acyclic digraph obtained after inverting X_1 and X_2 (in symbols $D^* = \text{Inv}(D; (X_1, X_2))$).

Let us define some sets. See Figure 2.

- For $i \in [2]$, $X_i^L = X_i \cap V(L)$ and $X_i^R = X_i \cap V(R)$.
- $Z^L = V(L) \setminus (X_1^L \cup X_2^L)$ and $Z^R = V(R) \setminus (X_1^R \cup X_2^R)$.
- $X_{12}^L = X_1^L \cap X_2^L$ and $X_{12}^R = X_1^R \cap X_2^R$.
- for $\{i, j\} = \{1, 2\}$, $X_{i-j}^L = (X_i^L \setminus X_j^L)$ and $X_{i-j}^R = (X_i^R \setminus X_j^R)$.

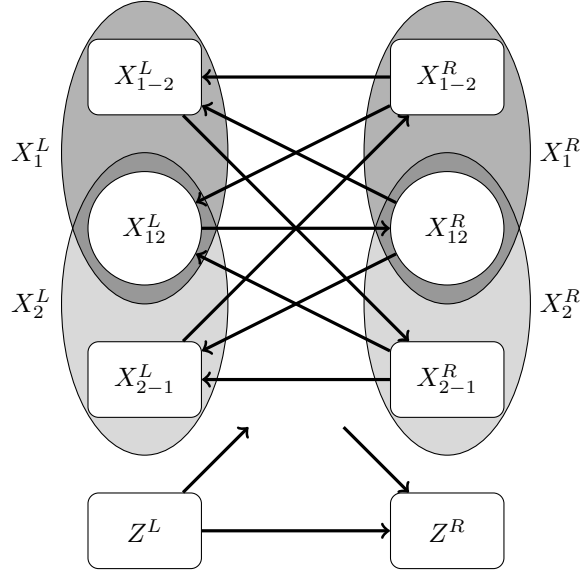

Figure 2: The oriented graph D^*

Observe that at least one of the sets $X_{1-2}^L, X_{2-1}^R, X_{2-1}^L$ and X_{1-2}^R must be empty, otherwise D^* is not acyclic. By symmetry, we may assume that it is X_{1-2}^R or X_{2-1}^R . Observe moreover that $X_{1-2}^R \cup X_{2-1}^R \neq \emptyset$ for otherwise $X_1^F = X_2^F = X_{12}^F$ and $D^*(V(F)) = F$ is not acyclic.

Assume first that $X_{1-2}^R = \emptyset$ and so $X_{2-1}^R \neq \emptyset$.

Suppose for a contradiction that $X_{12}^R \neq \emptyset$ and let $a \in X_{2-1}^R, b \in X_{12}^R$. Let C be a directed cycle in L . Note that $V(C)$ cannot be contained in one of the sets X_{1-2}^L, X_{12}^L or X_{2-1}^L . If $V(C) \cap Z^L \neq \emptyset$, there is an arc $cd \in A(L)$ such that $c \in X_{1-2}^L \cup X_{12}^L \cup X_{2-1}^L$ and $d \in Z^L$. Then, either (c, d, a, c) or (c, d, b, c) is a directed cycle in D^* , a contradiction. Thus, $V(C) \subseteq X_{1-2}^L \cup X_{12}^L \cup X_{2-1}^L$. If $V(C) \cap X_{12}^L \neq \emptyset$, then there is an arc $cd \in A(L)$ such that $c \in X_{12}^L$ and $d \in X_{1-2}^L \cup X_{2-1}^L$ which means that $dc \in A(D^*)$ and (d, c, b, d) is a directed cycle in D^* , a contradiction. Hence $V(C) \subseteq X_{1-2}^L \cup X_{2-1}^L$ and there exists an arc $cd \in A(L)$ such that $c \in X_{2-1}^L, d \in X_{1-2}^L$ and (c, d, a, c) is a directed cycle in D^* , a contradiction.

Therefore $X_{12}^R = \emptyset$ and every directed cycle of R has its vertices in $X_{2-1}^R \cup Z^R$. Then, there is an arc $ea \in A(R)$ with $a \in X_{2-1}^R$ and $e \in Z^R$. Note that, in this case, $ea \in A(D^*)$ and (e, a, c, e) is a directed cycle in D^* for any $c \in X_{12}^L \cup X_{2-1}^L$. Thus, $X_{12}^L = X_{2-1}^L = \emptyset$ and $X_1 \subset V(L), X_2 \subset V(R)$.

If $X_{2-1}^R = \emptyset$, we can symmetrically apply the same arguments to conclude that $X_1 \subset V(R)$ and $X_2 \subset V(L)$. \square

Theorem 3.4. *Let L and R be two oriented graphs. If $\text{inv}(L) = 1$ and $\text{inv}(R) = 2$, then $\text{inv}(L \rightarrow R) = 3$.*

Proof. Let $D = (L \rightarrow R)$. By Proposition 3.1, we know that $\text{inv}(D) \leq 3$.

Assume for a contradiction that $\text{inv}(D) \leq 2$. Let (X_1, X_2) be a decycling family of D and let $D^* = \text{Inv}(D; (X_1, X_2))$. Let $L^* = D^* \langle V(L) \rangle$ and $R^* = D^* \langle V(F) \rangle$. We define the sets $X_1^L, X_2^L, X_1^R, X_2^R, Z^L, Z^R, X_{12}^L, X_{12}^R, X_{1-2}^L, X_{2-1}^L, X_{1-2}^R$, and X_{2-1}^R as in Theorem 3.3. See Figure 2. Note that each of these sets induces an acyclic digraph in D^* and thus also in D . For $i \in [2]$, let $D_i = \text{Inv}(D; X_i)$, let $L_i = \text{Inv}(L, X_i^L) = \text{Inv}(L^*; X_{2-i}^L)$, and $R_i = \text{Inv}(R, X_i^R) = \text{Inv}(R^*; X_{2-i}^R)$. Since $\text{inv}(D) = 2$, $\text{inv}(D_1) = \text{inv}(D_2) = 1$. Since $\text{inv}(R) = 2$, R_1 and R_2 are both non-acyclic, so $\text{inv}(R_1) = \text{inv}(R_2) = 1$.

Claim 1: $X_i^L, X_i^R \neq \emptyset$ for all $i \in [2]$.

Proof. Since $\text{inv}(R) = 2$, necessarily, $X_1^R, X_2^R \neq \emptyset$.

Suppose now that $X_i^L = \emptyset$. Then $D_i = L \rightarrow R_i$. As $\text{inv}(L) \geq 1$ and $\text{inv}(R_i) \geq 1$, by Proposition 3.2 $\text{inv}(D_i) \geq 2$, a contradiction. \diamond

Claim 2: $X_1^L \neq X_2^L$ and $X_1^R \neq X_2^R$.

Proof. If $X_1^L = X_2^L$, then $L^* = L$, so L^* is not acyclic, a contradiction. Similarly, If $X_1^R = X_2^R$, then $R^* = R$, so R^* is not acyclic, a contradiction. \diamond

In particular, Claim 2 implies that $X_{1-2}^L \cup X_{2-1}^L \neq \emptyset$.

In the following, we denote by $A \rightsquigarrow B$ the fact that there is no arc from B to A .

Assume first that $X_{1-2}^R = \emptyset$. By Claim 1, $X_1^R \neq \emptyset$, so $X_{12}^R \neq \emptyset$ and by Claim 2, $X_1^R \neq X_2^R$, so $X_{2-1}^R \neq \emptyset$.

If $X_{2-1}^L \neq \emptyset$, then, in D^* , $X_{2-1}^R \cup X_{12}^R \rightsquigarrow Z^R$ because $X_{2-1}^R \cup X_{12}^R \rightarrow X_{2-1}^L \rightarrow Z^R$. But then $R_1 = \text{Inv}(R^*; X_2^R)$ would be acyclic, a contradiction. Thus, $X_{2-1}^L = \emptyset$.

Then by Claims 1 and 2, we get $X_{12}^L, X_{1-2}^L \neq \emptyset$. Hence, as $X_{12}^R \rightarrow X_{1-2}^L \rightarrow X_{2-1}^R \rightarrow X_{12}^L \rightarrow X_{12}^R$ in D^* , there is a directed cycle in D^* , a contradiction. Therefore $X_{1-2}^R \neq \emptyset$.

In the same way, one shows that $X_{2-1}^R \neq \emptyset$. As $X_{1-2}^R \rightarrow X_{1-2}^L \rightarrow X_{2-1}^R \rightarrow X_{2-1}^L \rightarrow X_{1-2}^R$ in D^* , and D^* is acyclic, one of X_{1-2}^L and X_{2-1}^L must be empty. Without loss of generality, we may assume $X_{1-2}^L = \emptyset$.

Then by Claims 1 and 2, we have $X_{12}^L, X_{1-2}^L \neq \emptyset$. Furthermore $X_{12}^R = \emptyset$ because $X_{12}^R \rightarrow X_{2-1}^L \rightarrow X_{1-2}^R \rightarrow X_{12}^L \rightarrow X_{12}^R$ in D^* . Now in D^* , $X_{2-1}^R \rightsquigarrow X_{1-2}^R \cup Z^R$ because $X_{2-1}^R \rightarrow X_{2-1}^L \rightarrow X_{1-2}^R \cup Z^R$, and $X_{1-2}^R \rightsquigarrow Z^R$ because $X_{1-2}^R \rightarrow X_{12}^L \rightarrow Z^R$. Thus, in D , we also have $X_{2-1}^R \rightsquigarrow X_{1-2}^R \cup Z^R$ and $X_{1-2}^R \rightsquigarrow Z^R$. So R is acyclic, a contradiction to $\text{Inv}(R) = 2$.

Therefore $\text{inv}(D) \geq 3$. So $\text{inv}(D) = 3$. \square

Corollary 3.5. $\text{inv}(D) = 1$ if and only if $\text{inv}(D \rightarrow D) = 2$.

Theorem 3.6. Let L and R be strong digraphs such that $\text{inv}(L), \text{inv}(R) \geq 2$. Then $\text{inv}(L \rightarrow R) \geq 4$.

Due to lack of space, the proof of this theorem is left in appendix.

Corollary 3.7. Let L and R be strong digraphs such that $\text{inv}(L), \text{inv}(R) = 2$. Then $\text{inv}(L \rightarrow R) = 4$.

4 Inversion number of intercylic digraphs

A digraph D is **intercylic** if $\nu(D) = 1$. The aim of this subsection is to prove the following theorem.

Theorem 4.1. If D is an intercylic oriented graph, then $\text{inv}(D) \leq 4$.

In order to prove this theorem, we need some preliminaries.

Let D be an oriented graph. An arc uv is **weak** in D if $\min\{d^+(u), d^-(v)\} = 1$. An arc is **contractable** in D if it is weak and in no directed 3-cycle. If a is a contractable arc, then let D/a be the digraph obtained by contracting the arc a and \tilde{D}/a be the oriented graph obtained from D by removing one arc from every pair of parallel arcs created in D/a .

Lemma 4.2. *Let D be a strong oriented graph and let a be a contractable arc in D . Then D/a is a strong intercyclic oriented graph and $\text{inv}(\tilde{D}/a) \geq \text{inv}(D)$.*

Proof. McCuaig proved that D/a is strong and intercyclic. Let us prove that $\text{inv}(D) \leq \text{inv}(\tilde{D}/a)$. Observe that $\text{inv}(\tilde{D}/a) = \text{inv}(D/a)$.

Set $a = uv$, and let w be the vertex corresponding to both u and v in D/a . Let (X'_1, \dots, X'_p) be a decycling family of $D' = \tilde{D}/a$ that result in an acyclic oriented graph R' . For $i \in [p]$, let $X_i = X'_i$ if $w \notin X'_i$ and $X_i = (X'_i \setminus \{w\}) \cup \{u, v\}$ if $w \in X'_i$. Let $a^* = uv$ if w is in an even number of X'_i and $a^* = vu$ otherwise, and let $R = \text{Inv}(D; (X_1, \dots, X_p))$. One easily shows that $R = R'/a^*$. Therefore R is acyclic since the contraction of an arc transforms a directed cycle into a directed cycle. \square

Lemma 4.3. *Let D be an intercyclic oriented graph. If there is a non-contractable weak arc, then $\text{inv}(D) \leq 4$.*

Proof. Let uv be a non-contractable weak arc. By directional duality, we may assume that $d^-(v) = 1$. Since uv is non-contractable, uv is in a directed 3-cycle (u, v, w, u) . Since D is intercyclic, we have $D \setminus \{u, v, w\}$ is acyclic. Consequently, $\{w, u\}$ is a cycle transversal of D , because every directed cycle containing v also contains u . Hence, by Theorem 1.1, $\text{inv}(D) \leq \tau(D) \leq 4$. \square

The description below follows [3]. A digraph D is **in reduced form** if it is strongly connected, and it has no weak arc, that is $\min\{\delta^-(D), \delta^+(D)\} \geq 2$.

Intercyclic digraphs in reduced form were characterized by Mc Cuaig [10]. In order to restate his result, we need some definitions. Let $\mathcal{P}(x_1, \dots, x_s; y_1, \dots, y_t)$ be the class of acyclic digraphs D such that x_1, \dots, x_s , $s \geq 2$, are the sources of D , y_1, \dots, y_t , $t \geq 2$, are the sinks of D , every vertex which is neither a source nor a sink has in- and out-degree at least 2, and, for $1 \leq i < j \leq s$ and $1 \leq k < \ell \leq t$, every (x_i, y_ℓ) -path intersects every (x_j, y_k) -path. By a theorem of Metzlar [11], such a digraph can be embedded in a disk such that $x_1, x_2, \dots, x_s, y_t, y_{t-1}, \dots, y_1$ occur, in this cyclic order, on its boundary. Let \mathcal{T} be the class of digraphs with minimum in- and out-degree at least 2 which can be obtained from a digraph in $\mathcal{P}(x^+, y^+; x^-, y^-)$ by identifying $x^+ = x^-$ and $y^+ = y^-$. Let D_7 be the digraph from Figure 3(a).

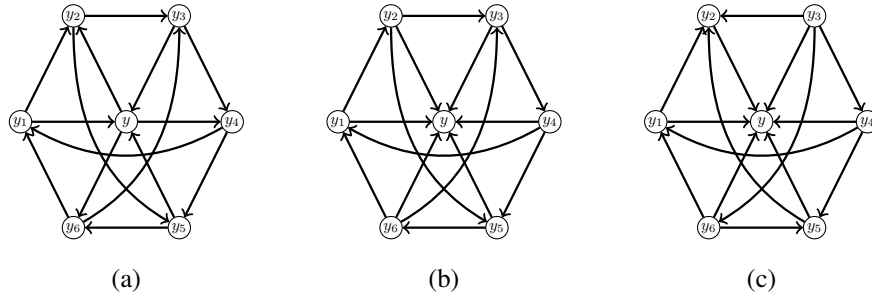

Figure 3: (a): the digraph D_7 ; (b): the digraph D_7' obtained from D_7 inverting the set $\{y, y_2, y_4, y_6\}$; (c): the acyclic digraph D_7'' obtained from D_7' by inverting the set $\{y_2, y_3, y_5, y_6\}$.

Let \mathcal{K} be the class of digraphs D with $\tau(D) \geq 3$ and $\delta^0(D) \geq 2$ which can be obtained from a digraph K_H from $\mathcal{P}(w_0, z_0; z_1, w_1)$ by adding at most one arc connecting w_0, z_0 , adding at most one arc connecting w_1, z_1 , adding a directed 4-cycle $(x_0, x_1, x_2, x_3, x_0)$ disjoint from K_H and adding eight single arcs $w_1x_0, w_1x_2, z_1x_1, z_1x_3, x_0w_0, x_2w_0, x_1z_0, x_3z_0$ (see Figure 4). Let \mathcal{H} be the class of digraphs D with $\tau(D) \geq 3$ and $\delta^0(D) \geq 2$ such that D is the union of three arc-disjoint digraphs $H_\alpha \in \mathcal{P}(y_4, y_3, y_1; y_5, y_2)$, $H_\beta \in \mathcal{P}(y_4, y_5; y_3, y_1, y_2)$, and $H_\gamma \in \mathcal{P}(y_1, y_2; y_3, y_4)$, where y_1, y_2, y_3, y_4, y_5 are the only vertices in D occurring in more than one of $H_\alpha, H_\beta, H_\gamma$ (see Figure 5).

Theorem 4.4 (McCuaig [10]). *The class of intercyclic digraphs in reduced form is $\mathcal{T} \cup \{D_7\} \cup \mathcal{K} \cup \mathcal{H}$.*

Using this characterization we can now prove the following.

Corollary 4.5. *If D is an intercyclic oriented graph in reduced form, then $\text{inv}(D) \leq 4$.*

Proof. Let D be an intercyclic oriented graph in reduced form. By Theorem 4.4, it is in $\mathcal{T} \cup \{D_7\} \cup \mathcal{K} \cup \mathcal{H}$.

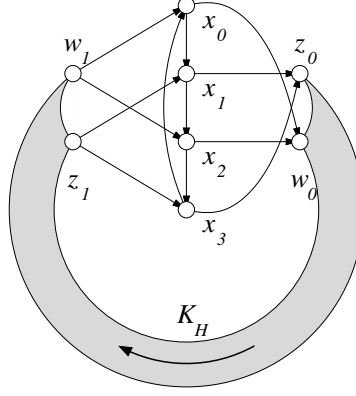

Figure 4: The digraphs from \mathcal{K} . The arrow in the grey area symbolizing the acyclic (plane) digraph K_H indicates that z_0, w_0 are its sources and z_1, w_1 are its sinks.

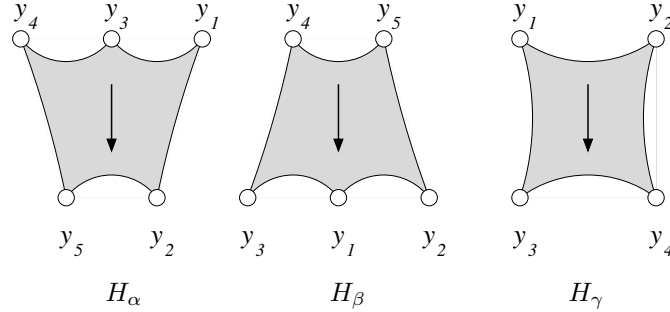

Figure 5: The digraphs from \mathcal{H} .

If $D \in \mathcal{T}$, then it is obtained from a digraph D' in $\mathcal{P}(x^+, y^+; x^-, y^-)$ by identifying $x^+ = x^-$ and $y^+ = y^-$. Thus $D - \{x^+, y^+\} = D' - \{x^+, y^+, x^-, y^-\}$ is acyclic. Hence $\tau(D) \leq 2$, and so by Theorem 1.1, $\text{inv}(D) \leq 4$.

If $D = D_7$, then inverting $X_1 = \{y, y_2, y_4, y_6\}$ so that y becomes a source and then inverting $\{y_2, y_3, y_5, y_6\}$, we obtain an acyclic digraph with acyclic ordering $(y, y_6, y_3, y_4, y_5, y, y_2)$. Hence $\text{inv}(D_7) \leq 2$.

If $D \in \mathcal{K}$, then inverting $\{x_0, x_3\}$ and $\{x_0, x_1, x_2, x_3, w_1, z_1\}$, we convert D to an acyclic digraph with acyclic ordering $(x_3, x_2, x_1, x_0, v_1, \dots, v_p)$ where (v_1, \dots, v_p) is an acyclic ordering of K_H .

If $D \in \mathcal{H}$, then consider $D' = \text{Inv}(D, V(H_\gamma))$. The oriented graph D is the union of $H_\alpha \in \mathcal{P}(y_4, y_3, y_1; y_5, y_2)$, $H_\beta \in \mathcal{P}(y_4, y_5; y_3, y_1, y_2)$, and \overleftarrow{H}_γ , the converse of H_γ . As $H_\gamma \in \mathcal{P}(y_1, y_2; y_3, y_4)$, we have $\overleftarrow{H}_\gamma \in \mathcal{P}(y_4, y_3; y_2, y_1)$. Set $Y = \{y_1, y_2, y_3, y_4, y_5\}$.

We claim that every directed cycle C' of D' contains y_5 . Since $D' - Y$ is acyclic, C' is the concatenation of directed paths P_1, P_2, \dots, P_q with both end-vertices in Y and no internal vertex in Y . Now let C be the directed cycle obtained from C' by replacing each P_i by an arc from its initial vertex to its terminal vertex. Clearly, C contains y_5 if and only if C' does. But C is a directed cycle in J the digraph with vertex set Y in which $\{y_4, y_3, y_1\} \rightarrow \{y_5, y_2\}$, $\{y_4, y_5\} \rightarrow \{y_3, y_1, y_2\}$, and $\{y_4, y_3\} \rightarrow \{y_1, y_2\}$. One easily checks that $J - y_5$ is acyclic with acyclic ordering (y_4, y_3, y_1, y_2) , so C contains y_5 and so does C' .

Consequently, $\{y_5\}$ is a cycle transversal of D' . Hence, by Theorem 1.1 (ii), we have $\text{inv}(D') \leq 2\tau(D') \leq 2$. As D' is obtained from D by inverting one set, we get $\text{inv}(D) \leq 3$. \square

We can now prove Theorem 4.1.

Proof. By induction on the number of vertices of D .

If D is not strong, then it has a unique non-trivial strong component C and any decycling family of C is a decycling family of D , so $\text{inv}(C) = \text{inv}(D)$. By the induction hypothesis, $\text{inv}(C) \leq 4$, so $\text{inv}(D) \leq 4$. Henceforth, we may assume that D is strong.

Assume now that D has a weak arc a . If a is non-contractable, then $\text{inv}(D) \leq 9$ by Lemma 4.3. If a is contractable, then consider \tilde{D}/a . As observed by McCuaig [10], D/a is also intercylic. So by Lemma 4.2 and the induction hypothesis, $\text{inv}(D) \leq \text{inv}(D/a) \leq 4$. Henceforth, we may assume that D has no weak arc.

Thus D is in a reduced form and by Corollary 4.5, $\text{inv}(D) \leq 4$. \square

5 Complexity results

5.1 NP-hardness of 1-INVERSION and 2-INVERSION

Theorem 5.1. *1-INVERSION is NP-complete even when restricted to strong digraphs.*

In order to prove this theorem, we need some preliminaries.

Let J be the digraph depicted in Figure 6.

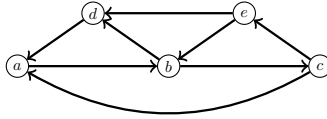

Figure 6: The digraph J

Lemma 5.2. *The only sets whose inversion can make J acyclic are $\{a, b, e\}$ and $\{b, c, d\}$.*

Proof. Assume that an inversion on X makes D acyclic. Then X must contain exactly two vertices of each of the directed 3-cycles (a, b, c, a) , (a, b, d, a) , and (e, b, c, e) , and cannot be $\{a, c, d, e\}$ for otherwise (e, b, d, e) is a directed cycle in the resulting digraph. Hence X must be either $\{a, b, e\}$ or $\{b, c, d\}$. One can easily check that an inversion on any of these two sets makes D acyclic. \square

Proof of Theorem 5.1. Reduction from MONOTONE 1-IN-3 SAT which is well-known to be NP-complete.

Let Φ be a monotone 3-SAT formula with variables x_1, \dots, x_n and clauses C_1, \dots, C_m . Let D be the digraph constructed as follows. For every $i \in [n]$, let us construct a variable digraph K_i as follows: for every $j \in [m]$, create a copy J_i^j of J , and then identify all the vertices c_i^j into one vertex c_i . Then, for every clause $C_j = x_{i_1} \vee x_{i_2} \vee x_{i_3}$, we add the arcs of the directed 3-cycle $D_j = (a_{i_1}^j, a_{i_2}^j, a_{i_3}^j)$.

Observe that D is strong. We shall prove that $\text{inv}(D) = 1$ if and only if Φ admits a 1-in-3-SAT assignment.

Assume first that $\text{inv}(D) = 1$. Let X be a set whose inversion makes D acyclic. By Lemma 5.2, for every $i \in [n]$, either $X \cap V(K_i) = \bigcup_{j=1}^m \{a_i^j, b_i^j, e_i^j\}$ or $X \cap V(K_i) = \bigcup_{j=1}^m \{b_i^j, c_i, d_i^j\}$. Let φ be the truth assignment defined by $\varphi(x_i) = \text{true}$ if $X \cap V(K_i) = \bigcup_{j=1}^m \{b_i^j, c_i, d_i^j\}$, and $\varphi(x_i) = \text{false}$ if $X \cap V(K_i) = \bigcup_{j=1}^m \{a_i^j, b_i^j, e_i^j\}$.

Consider a clause $C_j = x_{i_1} \vee x_{i_2} \vee x_{i_3}$. Because D_j is a directed 3-cycle, X contains exactly two vertices in $V(D_j)$. Let ℓ_1 and ℓ_2 be the two indices of $\{i_1, i_2, i_3\}$ such that $a_{\ell_1}^j$ and $a_{\ell_2}^j$ are in X and ℓ_3 be the third one. By our definition of φ , we have $\varphi(x_{\ell_1}) = \varphi(x_{\ell_2}) = \text{false}$ and $\varphi(x_{\ell_3}) = \text{true}$. Therefore, φ is a 1-in-3 SAT assignment.

Assume now that Φ admits a 1-in-3 SAT assignment φ . For every $i \in [n]$, let $X_i = \bigcup_{j=1}^m \{b_i^j, c_i, d_i^j\}$ if $\varphi(x_i) = \text{true}$ and $X_i = \bigcup_{j=1}^m \{a_i^j, b_i^j, e_i^j\}$ if $\varphi(x_i) = \text{false}$, and set $X = \bigcup_{i=1}^n X_i$.

Let D' be the graph obtained from D by the inversion on X . We shall prove that D' is acyclic, which implies $\text{inv}(D) = 1$.

Assume for a contradiction that D' contains a cycle C . By Lemma 5.2, there is no cycle in any variable gadget K_i , so C must contain an arc with both ends in $V(D_j)$ for some j . Let $C_j = x_{i_1} \vee x_{i_2} \vee x_{i_3}$. Now since φ is a 1-in-3-SAT

assignment, w.l.o.g., we may assume that $\varphi(x_{i_1}) = \varphi(x_{i_2}) = \text{false}$ and $\varphi(x_{i_3}) = \text{true}$. Hence in D' , $a_{i_2}^j \rightarrow a_{i_1}^j$, $a_{i_2}^j \rightarrow a_{i_3}^j$, and $a_{i_3}^j \rightarrow a_{i_1}^j$. Moreover, in $D' \langle V(J_{i_1}^j) \rangle$, $a_{i_1}^j$ is a sink, so $a_{i_1}^j$ is a sink in D' . Therefore C does not go through $a_{i_1}^j$, and thus C contains the arc $a_{i_2}^j a_{i_3}^j$, and then enter $J_{i_3}^j$. But in $D' \langle V(J_{i_3}^j) \rangle$, $a_{i_3}^j$ has a unique out-neighbour, namely $b_{i_3}^j$, which is a sink. This is a contradiction. \square

Corollary 5.3. 2-INVERSION is NP-complete.

Proof. By Corollary 3.5, we have $\text{inv}(D \rightarrow D) = 2$ if and only $\text{inv}(D) = 1$, so the statement follows from Theorem 5.1. \square

5.2 Solving k -TOURNAMENT-INVERSION for $k \in \{1, 2\}$

Theorem 5.4. 1-TOURNAMENT-INVERSION can be solved in $O(n^3)$ time.

Proof. Let T be a tournament. For every vertex v one can check whether there is an inversion that transforms T into a transitive tournament with source v . Indeed the unique possibility inversion is the one on the closed in-neighbourhood of v , $N^-[v] = N^-(v) \cup \{v\}$. So one can make inversion on $N^-[v]$ and check whether the resulting tournament is transitive. This can obviously be done in $O(n^2)$ time

Doing this for every vertex v yields an algorithm which solves 1-TOURNAMENT-INVERSION in $O(n^3)$ time. \square

Theorem 5.5. 2-TOURNAMENT-INVERSION can be solved in $O(n^6)$ time.

The main idea to prove this theorem is to consider every pair (s, t) of vertices and to check whether there are two sets X_1, X_2 such that the inversion of X_1 and X_2 results in a transitive tournament with source s and sink t . We need some definitions and lemmas.

The **symmetric difference** of two sets A and B is $A \Delta B = (A \setminus B) \cup (B \setminus A)$.

Let T be a tournament and let s and t be two vertices of T . We define the following four sets

$$\begin{aligned} A(s, t) &= N^+(s) \cap N^-(t) \\ B(s, t) &= N^-(s) \cap N^+(t) \\ C(s, t) &= N^+(s) \cap N^+(t) \\ D(s, t) &= N^-(s) \cap N^-(t) \end{aligned}$$

Lemma 5.6. Let T be a tournament and let s and t be two vertices of T . Assume there are two sets X_1, X_2 such that the inversion of X_1 and X_2 results in a transitive tournament with source s and sink t .

- (1) If $\{s, t\} \subseteq X_1 \setminus X_2$, then $ts \in A(T)$, $C(s, t) = D(s, t) = \emptyset$ and $X_1 = \{s, t\} \cup B(s, t)$.
- (2) If $s \in X_1 \setminus X_2$, $t \in X_2 \setminus X_1$, and the inversion of X_1 and X_2 makes T acyclic, then $st \in A(T)$, $A(s, t) \cap (X_1 \cup X_2) = \emptyset$, $X_1 = \{s\} \cup B(s, t) \cup D(s, t)$, and $X_2 = \{t\} \cup B(s, t) \cup C(s, t)$.
- (3) If $s \in X_1 \cap X_2$ and $t \in X_1 \setminus X_2$, then $ts \in A(T)$, $X_1 = \{s, t\} \cup B(s, t) \cup C(s, t)$, and $X_2 = \{s\} \cup C(s, t) \cup D(s, t)$.
- (4) If $\{s, t\} \subseteq X_1 \cap X_2$, then $st \in A(T)$, $C(s, t) = \emptyset$, $D(s, t) = \emptyset$, $X_1 \cap X_2 \subseteq A(s, t) \cup \{s, t\}$, and $B(s, t) = X_1 \Delta X_2$.

Proof. (1) The arc between s and t is reversed once, so $ts \in A(T)$.

Assume for a contradiction, that there is a vertex $c \in C(s, t)$. The arc tc must be reversed, so $c \in X_1$, but then the arc sc is reversed contradicting the fact that s becomes a source. Hence $C(s, t) = \emptyset$. Similarly $D(s, t) = \emptyset$.

The arcs from t to $B(s, t)$ and from $B(s, t)$ to s are reversed so $B(s, t) \subseteq X_1$. The arcs from s to $A(s, t)$ and from $A(s, t)$ to t are not reversed so $A(s, t) \cap X_1 = \emptyset$. Therefore $X_1 = \{s, t\} \cup B(s, t)$.

(2) The arc between s and t is not reversed, so $st \in A(T)$. The arcs from s to $A(s, t)$ and from $A(s, t)$ to t are not reversed so $A(s, t) \cap X_1 = \emptyset$ and $A(s, t) \cap X_2 = \emptyset$. The arcs from t to $B(s, t)$ and from $B(s, t)$ to s are reversed so $B(s, t) \subseteq X_1$ and $B(s, t) \subseteq X_2$. The arcs from s to $C(s, t)$ are not reversed so $C(s, t) \cap X_1 = \emptyset$ and the arcs

from t to $C(s, t)$ are reversed so $C(s, t) \subseteq X_2$. The arcs from $D(s, t)$ to s are reversed so $D(s, t) \subseteq X_1$ and the arcs from $D(s, t)$ to d are not reversed so $D(s, t) \cap X_2 = \emptyset$. Consequently, $X_1 = \{s\} \cup B(s, t) \cup D(s, t)$, and $X_2 = \{t\} \cup B(s, t) \cup C(s, t)$.

(3) The arc between s and t is reversed, so $ts \in A(T)$. The arcs from $A(s, t)$ to t are not reversed so $A(s, t) \cap X_1 = \emptyset$. The arcs from s to $A(s, t)$ are not reversed so $A(s, t) \cap X_2 = \emptyset$. The arcs from t to $B(s, t)$ are reversed so $B(s, t) \subseteq X_1$. The arcs from $B(s, t)$ to s are reversed (only once) so $B(s, t) \cap X_2 = \emptyset$. The arcs from t to $C(s, t)$ are reversed so $C(s, t) \subseteq X_1$. The arcs from s to $C(s, t)$ must be reversed twice so $C(s, t) \subseteq X_2$. The arcs from $D(s, t)$ to t are not reversed so $D(s, t) \cap X_1 = \emptyset$. The arcs from $D(s, t)$ to s are reversed so $D(s, t) \subseteq X_2$. Consequently, $X_1 = \{s, t\} \cup B(s, t) \cup C(s, t)$, and $X_2 = \{s, t\} \cup C(s, t) \cup D(s, t)$.

(4) The arc between s and t is reversed twice, so $st \in A(T)$.

Assume for a contradiction, that there is a vertex $c \in C(s, t)$. The arc tc must be reversed, so c is in exactly one of X_1 and X_2 . But then the arc sc is reversed contradicting the fact that s becomes a source. Hence $C(s, t) = \emptyset$. Similarly $D(s, t) = \emptyset$. The arcs from s to $A(s, t)$ and from $A(s, t)$ to t are not reversed so every vertex of $A(s, t)$ is either in $X_1 \cap X_2$ or in $V(T) \setminus (X_1 \cup X_2)$. The arcs from t to $B(s, t)$ and from $B(s, t)$ to s are reversed so every vertex of $B(s, t)$ is either in $X_1 \setminus X_2$ or in $X_2 \setminus X_1$. Consequently, $X_1 \cap X_2 \subseteq A(s, t) \cup \{s, t\}$, and $B(s, t) = X_1 \Delta X_2$. \square

Lemma 5.7. *Let T be a tournament of order n and let s and t be two vertices of T .*

- (1) *One can decide in $O(n^3)$ time whether there are two sets X_1, X_2 such that the inversion of X_1 and X_2 results in a transitive tournament with source s and sink t and $\{s, t\} \subseteq X_1 \setminus X_2$.*
- (2) *One can decide in $O(n^2)$ time whether there are two sets X_1, X_2 such that the inversion of X_1 and X_2 results in a transitive tournament with source s and sink t and $s \in X_1 \setminus X_2$ and $t \in X_2 \setminus X_1$.*
- (3) *One can decide in $O(n^2)$ time whether there are two sets X_1, X_2 such that the inversion of X_1 and X_2 results in a transitive tournament with source s and sink t and $s \in X_1 \cap X_2$ and $t \in X_1 \setminus X_2$.*
- (4) *One can decide in $O(n^4)$ time whether there are two sets X_1, X_2 such that the inversion of X_1 and X_2 results in a transitive tournament with source s and sink t and $\{s, t\} \subseteq X_1 \cap X_2$.*

Proof. For all cases, we first compute $A(s, t)$, $B(s, t)$, $C(s, t)$, and $D(s, t)$, which can obviously be done in $O(n^2)$.

(1) By Lemma 5.6, we must have $ts \in A(T)$ and $C(s, t) = D(s, t) = \emptyset$. So we first check if this holds. Furthermore, by Lemma 5.6, we must have $X_1 = \{s, t\} \cup B(s, t)$. Therefore we invert $\{s, t\} \cup B(s, t)$ which results in a tournament T' . Observe that s is a source of T' and t is a sink of T' . Hence, we return ‘Yes’ if and only if $\text{inv}(T' - \{s, t\}) = 1$ which can be tested in $O(n^3)$ by Theorem 5.4.

(2) By Lemma 5.6, we must have $st \in A(T)$. So we first check if this holds. Furthermore, by Lemma 5.6, the only possibility is that $X_1 = \{s\} \cup B(s, t) \cup D(s, t)$, and $X_2 = \{t\} \cup B(s, t) \cup C(s, t)$. So we invert those two sets and check whether the resulting tournament is a transitive tournament with source s and sink t . This can be done in $O(n^2)$.

(3) By Lemma 5.6, we must have $ts \in A(T)$. So we first check if this holds. Furthermore, by Lemma 5.6, the only possibility is that $X_1 = \{s, t\} \cup B(s, t) \cup C(s, t)$, and $X_2 = \{s\} \cup C(s, t) \cup D(s, t)$. So we invert those two sets and check whether the resulting tournament is a transitive tournament with source s and sink t . This can be done in $O(n^2)$.

(4) By Lemma 5.6, we must have $st \in A(T)$, $C(s, t) = \emptyset$, $D(s, t) = \emptyset$. So we first check if this holds. Furthermore, by Lemma 5.6, the desired sets X_1 and X_2 must satisfy $X_1 \cap X_2 \subseteq A(s, t) \cup \{s, t\}$, and $B(s, t) = X_1 \Delta X_2$.

In particular, every arc of $T_A = T \langle A(s, t) \rangle$ is either not reversed or reversed twice (which is the same). Hence T_A must be a transitive tournament. So we check whether T_A is a transitive tournament and if yes, we find a directed hamiltonian path $P_A = (a_1, \dots, a_p)$ of it. This can be done in $O(n^2)$.

Now we check that $B(s, t)$ admits a partition (X'_1, X'_2) with $X'_i = X_i \cap B$ and the inversion of both X'_1 and X'_2 transforms $T \langle B(s, t) \rangle$ into a transitive tournament T_B with source s' and sink t' . The idea is to investigate all possibilities for s', t' and the sets X'_1 and X'_2 . Since (X'_1, X'_2) is a partition of $B(s, t)$ and (X'_1, X'_2) is a decycling family if and only if (X'_2, X'_1) is a decycling family, we may assume that

- (a) $\{s', t'\} \subseteq X'_1 \setminus X'_2$, or

(b) $s' \in X'_1 \setminus X'_2$ and $t' \in X'_2 \setminus X'_1$.

For the possibilities corresponding to Case (a), we proceed as in (1) above. For every arc $t's' \in A(T\langle B(s,t) \rangle)$, we check that $C(s',t') = D(s',t') = \emptyset$ (where those sets are computed in $T\langle B(s,t) \rangle$). Furthermore, by Lemma 5.6, we must have $X'_1 = \{s, t\} \cup B(s',t')$ and $X'_2 = B(s,t) \setminus X'_1$. So we invert those two sets and check whether the resulting tournament T_B is transitive. This can be done in $O(n^2)$ (or each arc $t's'$).

For a possibilities corresponding to Case (b), we proceed as in (2) above. For every arc $t's' \in A(T\langle B(s,t) \rangle)$, by Lemma 5.6, the only possibility is that $X'_1 = \{s'\} \cup B(s',t') \cup D(s',t')$, and $X'_2 = \{t'\} \cup B(s',t') \cup C(s',t')$. As those two sets form a partition of $B(s,t)$, we also must have $B(s',t') = \emptyset$ and $A(s',t') = \emptyset$. So we invert those two sets and check whether the resulting tournament T_B is transitive. This can be done in $O(n^2)$ for each arc $t's'$.

In both cases, we are left with a transitive tournament T_B . We compute its directed hamiltonian path $P_B = (b_1, \dots, b_q)$ which can be done in $O(n^2)$. We need to check whether this partial solution on $B(s,t)$ is compatible with the rest of the tournament, that is $\{s, t\} \cup A(s,t)$. It is obvious that it will always be compatible with s and t as they become source and sink. So we have to check that we can merge T_A and T_B into a transitive tournament on $A(s,t)$ and $B(s,t)$ after the reversals of X_1 and X_2 . In other words, we must interlace the vertices of P_A and P_B . Recall that $Z = X_1 \cap X_2 \setminus \{s, t\} \subseteq A(s,t)$ and $X_i = X'_i \cup Z \cup \{s, t\}$, $i \in [2]$ so the arcs between Z and $B(s,t)$ will be reversed exactly once when we invert X_1 and X_2 . Using this fact, one easily checks that this is possible if and only there are integers $j_1 \leq \dots \leq j_p$ such that

- either $b_j \rightarrow a_i$ for $j \leq j_i$ and $b_j \leftarrow a_i$ for $j > j_i$ (in which case $a_i \notin Z$ and the arcs between a_i and $B(s,t)$ are not reversed),
- or $b_j \leftarrow a_i$ for $j \leq j_i$ and $b_j \rightarrow a_i$ for $j > j_i$ (in which case $a_i \in Z$ and the arcs between a_i and $B(s,t)$ are reversed).

See Figure 7 for an illustration of a case when we can merge the two orderings after reversing X_1 and X_2 .

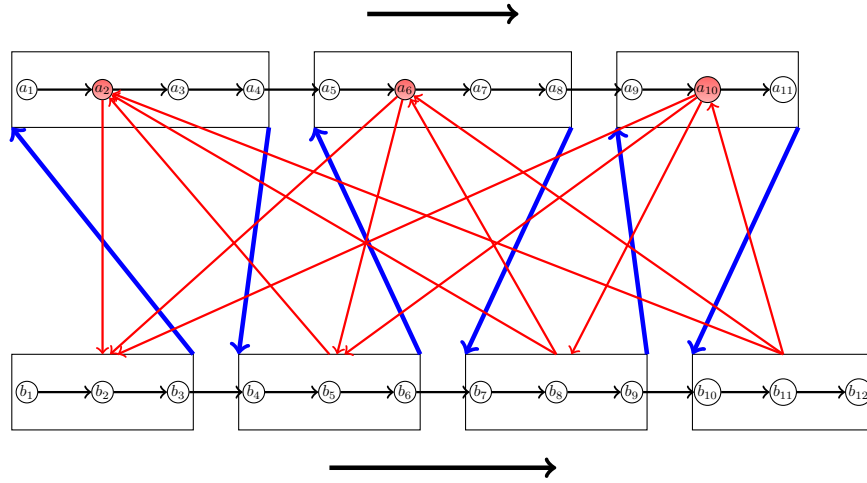

Figure 7: Indicating how to merge the two orderings of A and B . The fat blue edges indicate that the final ordering will be $b_1 - b_3, a_1 - a_4, b_4 - b_6, a_5 - a_8, b_7 - b_9, a_9 - a_{11}, b_{10} - b_{12}$. The set $Z = \{a_2, a_6, a_{10}\}$ consists of those vertices from $A(s,t)$ which are in $X_1 \cap X_2$. These vertices are shown in red. The red arcs between a vertex of Z and one of the boxes indicate that all arcs between the vertex and those of the box have the direction shown. Hence the boxes indicate that values of j_1, \dots, j_{11} satisfy that : $j_1 = \dots = j_4 = 3, j_5 = \dots = j_8 = 6, j_9 = \dots = j_{11} = 9$.

Deciding whether there are such indices can be done in $O(n^2)$ for each possibility.

As we have $O(n^2)$ possibilities, and for each possibility the procedure runs in $O(n^2)$ time. Hence the overall procedure runs in $O(n^4)$ time. \square

Proof of Theorem 5.5. By Lemma 2.2, by removing iterately the sources and sinks of the tournament, it suffices to solve the problem for a tournament with no sink and no source.

Now for each pair (s, t) of distinct vertices, one shall check whether there are two sets X_1, X_2 such that the inversion of X_1 and X_2 results in a transitive tournament with source s and sink t . Observe that since s and t are neither sources nor sinks in T , each of them must belong to at least one of X_1, X_2 . Therefore, without loss of generality, we are in one of the following possibilities:

- $\{s, t\} \subseteq X_1 \setminus X_2$. Such a possibility can be check in $O(n^3)$ by Lemma 5.7 (1).
- $s \in X_1 \setminus X_2$ and $t \in X_2 \setminus X_1$. Such a possibility can be check in $O(n^2)$ by Lemma 5.7 (2).
- $s \in X_1 \cap X_2$ and $t \in X_1 \setminus X_2$. Such a possibility can be check in $O(n^2)$ by Lemma 5.7 (3).
- $t \in X_1 \cap X_2$ and $s \in X_1 \setminus X_2$. Such a possibility is the directional dual of the preceding one. It can be tested in $O(n^2)$ by reversing all arcs and applying Lemma 5.7 (3).
- $\{s, t\} \subseteq X_1 \cap X_2$. Such a possibility can be check in $O(n^4)$ by Lemma 5.7 (4).

Since there are $O(n^2)$ pairs (s, t) and for each pair the procedure runs in $O(n^4)$, the algorithm runs in $O(n^6)$ time. \square

5.3 Computing related parameters when the inversion number is bounded

The aim of this subsection is to prove the following theorem.

Theorem 5.8. *Let γ be a parameter in τ, τ', ν . Given an oriented graph D with inversion number 1 and an integer k , it is NP-complete to decide whether $\gamma(D) \leq k$.*

Let D be a digraph. The **second subdivision** of D is the oriented graph $S_2(D)$ obtained from D by replacing every arc $a = uv$ by a directed path $P_a = (u, x_a, y_a, u)$ where x_a, y_a are two new vertices.

Proposition 5.9. *Let D be a digraph.*

- (i) $\text{inv}(S_2(D)) \leq 1$.
- (ii) $\tau'(S_2(D)) = \tau'(D)$, $\tau(S_2(D)) = \tau(D)$, and $\nu(S_2(D)) = \nu(D)$.

Proof. (i) Inverting the set $\bigcup_{a \in A(D)} \{x_a, y_a\}$ makes $S_2(D)$ acyclic. Indeed the x_a become sinks, the y_a become source and the other vertices form a stable set. Thus $\text{inv}(S_2(D)) = 1$.

(ii) There is a one-to-one correspondence between directed cycles in D and directed cycles in $S_2(D)$ (their second subdivision). Hence $\nu(S_2(D)) = \nu(D)$.

Moreover every cycle transversal S of D is also a cycle transversal of $S_2(D)$. So $\tau(S_2(D)) \leq \tau(D)$. Now consider a cycle transversal T . If x_a or y_a is in S for some $a \in A(D)$, then we can replace it by any end-vertex of a . Therefore, we may assume that $T \subseteq V(D)$, and so T is a cycle transversal of D . Hence $\tau(S_2(D)) = \tau(D)$.

Similarly, consider a cycle arc-transversal F of D . Then $F' = \{a \mid x_a y_a \in F\}$ is a cycle arc-transversal of $S_2(D)$. Conversely, consider a cycle arc-transversal F' of $S_2(D)$. Replacing each arc incident to x_a, y_a by $x_a y_a$ for each $a \in A(D)$, we obtain another cycle arc-transversal. So we may assume that $F' \subseteq \{x_a y_a \mid a \in A(D)\}$. Then $F = \{a \mid x_a y_a \in F'\}$ is a cycle arc-transversal of D . Thus $\tau'(S_2(D)) = \tau'(D)$. \square

Proof of Theorem 5.8. Since computing each of τ, τ', ν is NP-hard, Proposition 5.9 (ii) implies that computing each of τ, τ', ν is also NP-hard for second subdivisions of digraphs. As those oriented graphs have inversion number 1 (Proposition 5.9 (i)), computing each of τ, τ', ν is NP-hard for oriented graphs with inversion number 1. \square

Acknowledgement

The authors would like to thank Maurice Pouzet for suggesting the problem. There are very pleased to honour him on his 75th birthday.

This research was supported by the Independent Research Fund Denmark under grant number DFF 7014-00037B, and by the french Agence Nationale de la Recherche under contract Digraphs ANR-19-CE48-0013-01. This work was done while the Joergen Bang-Jensen was visiting team Coati, I3S and INRIA Sophia Antipolis. Hospitality and financial support is gratefully acknowledged. Ce travail a bénéficié d'une aide du gouvernement français, gérée par

l'Agence Nationale de la Recherche au titre du projet Investissements d'Avenir UCAJEDI portant la référence no ANR-15-IDEX-01. This work was done while the Jonas Costa Ferreira da Silva was spending his second year of PhD as "sandwich" in team Coati, I3S and INRIA Sophia Antipolis.

References

- [1] N. Alon. Ranking tournaments. *SIAM J. Discrete Math.*, 20:137–142, 2006.
- [2] J. Bang-Jensen and G. Gutin. *Digraphs: Theory, Algorithms and Applications*. Springer-Verlag, London, 2nd edition, 2009.
- [3] J. Bang-Jensen and M. Kriesell. On the problem of finding disjoint cycles and dicycles in a digraph. *Combinatorica*, 31:639–668, 2011.
- [4] J. Bang-Jensen and C. Thomassen. A polynomial algorithm for the 2-path problem for semicomplete digraphs. *SIAM J. Discrete Math.*, 5:366–376, 1992.
- [5] H. Belkhechine, M. Bouaziz, I. Boudabbous, and M. Pouzet. Inversions in tournaments. *Unpublished*.
- [6] H. Belkhechine, M. Bouaziz, I. Boudabbous, and M. Pouzet. Inversion dans les tournois. *Comptes Rendus Mathématique*, 348(13):703 – 707, 2010.
- [7] P. Charbit, S. Thomassé, and A. Yeo. The minimum feedback arc set problem is NP-hard for tournaments. *Combin. Probab. Comput.*, 16:1–4, 2007.
- [8] M. X. Goemans and D. P. Williamson. Primal-dual approximation algorithms for feedback problems in planar graphs. In W. H. Cunningham, S. T. McCormick, and M. Queyranne, editors, *Integer Programming and Combinatorial Optimization*, pages 147–161, Berlin, Heidelberg, 1996. Springer Berlin Heidelberg.
- [9] R. Karp. Reducibility among combinatorial problems. In *Complexity of computer computations (Proc. Symp., IBM Thomas J. Watson Res. Center, Yorktown Heights, N.Y., 1972)*, pages 85–103. Plenum, 1972.
- [10] W. McCuaig. Intercyclic digraphs. In N. Robertson and P. D. Seymour, editors, *Graph Structure Theory, Proceedings of a AMS-IMS-SIAM Joint Summer Research Conference on Graph Minors held June 22 to July 5, 1991, at the University of Washington, Seattle, USA*, volume 147 of *Contemporary Mathematics*, pages 203–245. American Mathematical Society, 1991.
- [11] A. Metzlar. *Minimum transversal of cycles in intercyclic digraphs*. PhD thesis, University of Waterloo, Ontario, Canada, 1989.
- [12] B. A. Reed, N. Robertson, P. D. Seymour, and R. Thomas. Packing directed circuits. *Combinatorica*, 16(4):535–554, 1996.
- [13] B. A. Reed and F. B. Shepherd. The gallai-younger conjecture for planar graphs. *Combinatorica*, 16(4):555–566, 1996.
- [14] E. Speckenmeyer. On feedback problems in digraphs. In *WG 1989*, volume 411 of *Lect. Notes Comput. Sci.*, pages 218–231. Springer, 1989.

Appendix: Dijoin of oriented graphs with inversion number 2

In this appendix, we give the proof of the following Theorem 3.6

Theorem 3.6. *Let L and R be strong digraphs such that $\text{inv}(L), \text{inv}(R) \geq 2$. Then $\text{inv}(L \rightarrow R) \geq 4$.*

Proof. Assume for a contradiction that there are two digraphs L and R such that $\text{inv}(L), \text{inv}(R) \geq 2$ and $\text{inv}(L \rightarrow R) = 3$. By Lemma 2.4 and Proposition 2.1, we can assume that L and R are tournaments.

By Theorem b3.4, $\text{inv}(L \rightarrow R) \geq 3$. Assume for a contradiction that $\text{inv}(L \rightarrow R) = 3$. Let (X_1, X_2, X_3) be a decycling sequence of $D = L \rightarrow R$ and denote the resulting acyclic (transitive) tournament by T . We will use the following notation. Below and in the whole proof, whenever we use subscripts i, j, k together we have $\{i, j, k\} = \{1, 2, 3\}$.

- $X_i^L = X_i \cap V(L), X_i^R = X_i \cap V(R)$ for all $i \in [3]$.
- $Z^L = V(L) \setminus (X_1^L \cup X_2^L \cup X_3^L)$ and $Z^R = V(R) \setminus (X_1^R \cup X_2^R \cup X_3^R)$
- $X_{123}^L = X_1^L \cap X_2^L \cap X_3^L, X_{123}^R = X_1^R \cap X_2^R \cap X_3^R$.
- $X_{ij-k}^L = (X_i^L \cap X_j^L) \setminus X_k^L$ and $X_{ij-k}^R = (X_i^R \cap X_j^R) \setminus X_k^R$.
- $X_{i-jk}^L = X_i^L \setminus (X_j^L \cup X_k^L)$ and $X_{i-jk}^R = X_i^R \setminus (X_j^R \cup X_k^R)$.

For any two (possibly empty) sets Q, W , we write $Q \rightarrow W$ to indicate that every $q \in Q$ has an arc to every $w \in W$. Unless otherwise specified, we are always referring to the arcs of T below. When we refer to arcs of the original digraph we will use the notation $u \Rightarrow v$, whereas we use $u \rightarrow v$ for arcs in T .

Claim A: $X_i^L, X_i^R \neq \emptyset$ for all $i \in [3]$.

Proof. Suppose w.l.o.g. that $X_1^R = \emptyset$ and let $D' = \text{Inv}(D; X_1)$. Then D' contains $C_3 \rightarrow R$ as an induced subdigraph since reversing X_1^L does not make L acyclic so there is still a directed 3-cycle (by Moon's theorem). \diamond

Claim B: *In T the following holds, implying that at least one of the involved sets is empty (as T is acyclic).*

- (a) $X_{123}^R \rightarrow X_{123}^L \rightarrow X_{ij-k}^R \rightarrow X_{ik-j}^L \rightarrow X_{123}^R$.
- (b) $X_{ij-k}^L \rightarrow X_{ij-k}^R \rightarrow X_{ik-j}^L \rightarrow X_{ik-j}^R \rightarrow X_{ij-k}^L$.

Proof. This follows from the fact that an arc of D is inverted if and only if it belongs to an odd number of the sets X_1, X_2, X_3 . \diamond

Claim C: *For all $i \neq j$, we have $X_i^L \neq X_j^L$ and $X_i^R \neq X_j^R$.*

Proof. Suppose this is not true, then without loss of generality $X_3^L = X_2^L$ but this contradicts that (X_1^L, X_2^L, X_3^L) is a decycling sequence of L as inverting X_2^L and X_3^L leaves every arc unchanged and we have $\text{inv}(L) = 2$. \diamond

Now we are ready to obtain a contradiction to the assumption that (X_1, X_2, X_3) is a decycling sequence for $D = L \rightarrow R$. We divide the proof into five cases. In order to increase readability, we will emphasize partial conclusions in **blue**, assumptions in **orange**, and indicate consequences of assumptions in **red**.

Case 1: $X_{i-jk}^L = \emptyset = X_{i-jk}^R$ for all i, j, k .

By Claim C, at least two of the sets $X_{12-3}^L, X_{13-2}^L, X_{23-1}^L$ are non-empty and at least two of the sets $X_{12-3}^R, X_{13-2}^R, X_{23-1}^R$ are non-empty. Without loss of generality, $X_{12-3}^L, X_{13-2}^L \neq \emptyset$. Now, by Claim B (b), implies that one of X_{12-3}^R, X_{13-2}^R must be empty. By interchanging the names of X_2, X_3 if necessary, we may assume that $X_{13-2}^R = \emptyset$ and hence, by Claim C, $X_{12-3}^R, X_{23-1}^R \neq \emptyset$. By Claim B (a), this implies $X_{23-1}^L = \emptyset$. Now

$X_{23-1}^R \rightarrow X_{12-3}^L \rightarrow X_{12-3}^R$, so $X_{23-1}^R \rightarrow X_{13-2}^R$. As $X_{12-3}^L \rightarrow X_{12-3}^R \rightarrow X_{13-2}^L$, we must have $X_{12-3}^L \rightarrow X_{13-2}^L$. By Claim B (a), $X_{123}^L \rightarrow X_{12-3}^R \rightarrow X_{13-2}^L \rightarrow X_{123}^R \rightarrow X_{123}^L$, so one of X_{123}^L and X_{123}^R is empty. W.l.o.g. we may assume $X_{123}^R = \emptyset$. As R is strong and X_{23-1}^R dominates X_{12-3}^R in R (these arcs are reversed by X_2), we must have $Z^R \neq \emptyset$. Moreover the arcs incident to Z^R are not reversed, so the set Z^R has an out-neighbour in $X_{12-3}^R \cup X_{23-1}^R$. But $X_{12-3}^R \cup X_{23-1}^R \rightarrow X_{13-2}^L \rightarrow Z^R$ so T has a directed 3-cycle, contradiction. This completes the proof of Case 1.

Case 2: Exactly one of $X_{1-23}^L, X_{2-13}^L, X_{3-12}^L, X_{1-23}^R, X_{2-13}^R, X_{3-12}^R$ is non-empty.

By reversing all arcs and switching the names of L and R if necessary, we may assume w.l.o.g that $X_{1-23}^L \neq \emptyset$. As $X_2^R \neq X_3^R$ we have $X_{12-3}^R \cup X_{13-2}^R \neq \emptyset$. By symmetry, we can assume that $X_{12-3}^R \neq \emptyset$.

Suppose for a contradiction that $X_{23-1}^R = \emptyset$. Then Claims A and C imply $X_{13-2}^R \neq \emptyset$. Now, by Claim B (b), one of X_{12-3}^L, X_{13-2}^L is empty. By symmetry, we can assume $X_{13-2}^L = \emptyset$. Now, by Claim C, $X_2^L \neq X_3^L$, so $X_{12-3}^L \neq \emptyset$. Note that $X_{12-3}^L \rightarrow X_{12-3}^R \rightarrow X_{1-23}^L$, thus $X_{12-3}^L \rightarrow X_{1-23}^L$ because T is acyclic. We also have $X_{123}^L \rightarrow X_{12-3}^L$ as $X_{123}^L \rightarrow X_{13-2}^R \rightarrow X_{12-3}^L$, and $X_{12-3}^L \rightarrow X_{23-1}^L$ as $X_{12-3}^L \rightarrow X_{12-3}^R \rightarrow X_{23-1}^L$. This implies that in L all arcs between X_{12-3}^L and $X_{23-1}^L \cup X_{123}^L \cup X_{1-23}^L$ are entering X_{12-3}^L (the arcs between X_{123}^L and X_{12-3}^L were reversed twice and those between $X_{1-23}^L \cup X_{23-1}^L$ and X_{12-3}^L were reversed once). Hence, as L is strong, we must have an arc uz from X_{12-3}^L to Z^L . But $Z^L \rightarrow X_{13-2}^R \rightarrow X_{12-3}^L$ so together with uz we have a directed 3-cycle in T , contradiction. Hence $X_{23-1}^R \neq \emptyset$.

Observe that $X_{12-3}^R \cup X_{13-2}^R \rightarrow X_{23-1}^R$ as $X_{12-3}^R \cup X_{13-2}^R \rightarrow X_{1-23}^L \rightarrow X_{23-1}^R$.

If $X_{12-3}^L \neq \emptyset$, then $X_{23-1}^R \rightarrow X_{12-3}^L \rightarrow X_{12-3}^R \rightarrow X_{23-1}^R$, a contradiction. So $X_{12-3}^L = \emptyset$. But $X_2^L \neq X_3^L$ by Claim C. Thus $X_{13-2}^L \neq \emptyset$. As $X_{23-1}^R \rightarrow X_{13-2}^L \rightarrow X_{123}^R$, we have $X_{23-1}^R \rightarrow X_{123}^R$. This implies that in R all the arcs between X_{23-1}^R and $X_{13-2}^R \cup X_{123}^R \cup X_{12-3}^R$ are leaving X_{23-1}^R . So as R is strong there must be an arc in R from Z^R to X_{23-1}^R . This arc is not reversed (in fact reversed twice), so it is also an arc in T . But since $X_{23-1}^R \rightarrow X_{13-2}^L \rightarrow Z^R$, this arc is in a directed 3-cycle, a contradiction. This completes Case 2.

Case 3: Exactly one of $X_{1-23}^L, X_{2-13}^L, X_{3-12}^L$ is non-empty and exactly one of $X_{1-23}^R, X_{2-13}^R, X_{3-12}^R$ is non-empty.

By symmetry we can assume $X_{1-23}^L \neq \emptyset$.

Subcase 3.1: $X_{1-23}^R \neq \emptyset$.

By Claim C, $X_2^L \neq X_3^L$, so one of X_{12-3}^L and X_{13-2}^L is non-empty. By symmetry we may assume $X_{12-3}^L \neq \emptyset$.

Suppose $X_{12-3}^R \neq \emptyset$. Then $X_{23-1}^R = \emptyset$ as $X_{1-23}^L \rightarrow X_{23-1}^R \rightarrow X_{12-3}^L \rightarrow X_{12-3}^R \rightarrow X_{1-23}^L$, and $X_{23-1}^L = \emptyset$ as $X_{1-23}^R \rightarrow X_{12-3}^L \rightarrow X_{12-3}^R \rightarrow X_{23-1}^L \rightarrow X_{1-23}^R$.

By Claim B (b), one of X_{13-2}^L, X_{13-2}^R is empty. By symmetry, we may assume $X_{13-2}^R = \emptyset$.

Observe that $V(R) \setminus Z^R = X_{123}^R \cup X_{12-3}^R \cup X_{1-23}^R$, so $V(R) \setminus Z^R \rightarrow X_{1-23}^L \rightarrow Z^R$, so $V(R) \setminus Z^R \rightarrow Z^R$. But all the arcs incident to Z^R are not inversed, so in R , there is no arc from Z^R to $V(R) \setminus Z^R$. Since R is strong, $Z^R = \emptyset$.

Now $X_{1-23}^R \rightarrow X_{12-3}^R \cup X_{123}^R$ because $X_{1-23}^R \rightarrow X_{12-3}^L \rightarrow X_{12-3}^R \cup X_{123}^R$. But all the arcs between X_{1-23}^R and $X_{12-3}^R \cup X_{123}^R = V(R) \setminus X_{1-23}^R$ are inversed from R to T . Hence in R , no arcs leaves X_{1-23}^R in R , a contradiction to R being strong.

Hence $X_{12-3}^R = \emptyset$. As $X_2^R \neq X_3^R$ this implies $X_{13-2}^R \neq \emptyset$.

Suppose that $X_{23-1}^R = \emptyset$, then $X_{123}^R \neq \emptyset$ because $X_2^R \neq \emptyset$ by Claim A. Furthermore $X_{13-2}^R \rightarrow X_{123}^R$ as $X_{13-2}^R \rightarrow X_{12-3}^L \rightarrow X_{123}^R$, and $X_{12-3}^L \rightarrow X_{1-23}^L$ as $X_{12-3}^L \rightarrow X_{123}^R \rightarrow X_{1-23}^L$. This implies that $X_{123}^L = \emptyset$ as $X_{123}^L \rightarrow X_{13-2}^R \rightarrow X_{123}^R \rightarrow X_{123}^L$.

Since L is strong, there must be an arc uv leaving X_{12-3}^L in L . But v cannot be in X_{1-23}^L since all vertices of this set dominate X_{12-3}^L in L . Moreover v cannot be in Z^L for otherwise (u, v, w, u) would be a directed 3-cycle in T for any $w \in X_{1-23}^R$ since $Z^L \rightarrow X_{1-23}^R \rightarrow X_{12-3}^L$. Hence $v \in X_{13-2}^L \cup X_{23-1}^L$, so $X_{13-2}^L \cup X_{23-1}^L \neq \emptyset$.

As $X_{13-2}^L \rightarrow X_{13-2}^R \rightarrow X_{23-1}^L \rightarrow X_{1-23}^R \rightarrow X_{13-2}^L$, precisely one of X_{13-2}^L, X_{23-1}^L is non-empty.

If $X_{13-2}^L \neq \emptyset$ and $X_{23-1}^L = \emptyset$, then $X_{13-2}^L \rightarrow X_{13-2}^R \rightarrow X_{1-23}^L \cup X_{12-3}^L$ implies that $X_{13-2}^L \rightarrow X_{1-23}^L \cup X_{12-3}^L$. As $d_L^+(X_{13-2}^L) > 0$ there exists $z \in Z^L$ such that there is an arc uz from X_{13-2}^L to Z^L , but then $z \rightarrow X_{1-23}^R \rightarrow u \rightarrow z$ is a contradiction. Hence $X_{13-2}^L = \emptyset$ and $X_{23-1}^L \neq \emptyset$. Then $X_{23-1}^L \rightarrow X_1^L$ as $X_{23-1}^L \rightarrow X_{1-23}^R \rightarrow X_1^L$.

Note that $Z^L = \emptyset$ as every vertex in $V(L) \setminus Z^L$ has an in-neighbour in $V(R)$ in T , implying that there can be no arc from $V(L) \setminus Z^L$ to Z^L in L . Thus $V(L) = X_{1-23}^L \cup X_{12-3}^L \cup X_{23-1}^L$ where each of these sets induces an acyclic subdigraph of L and we have $X_{1-23}^L \Rightarrow X_{12-3}^L \Rightarrow X_{23-1}^L \Rightarrow X_{1-23}^L$ in L . But now inverting the set $X_{1-23}^L \cup X_{23-1}^L$ makes L acyclic, a contradiction to $\text{inv}(L) = 2$. Thus $X_{23-1}^R \neq \emptyset$.

Suppose $X_{23-1}^L = \emptyset$. As above $Z^L = \emptyset$, so $V(L) = X_1^L$. As $X_{1-23}^L \rightarrow X_{23-1}^R \rightarrow X_{12-3}^L \cup X_{13-2}^L$ we have $X_{1-23}^L \rightarrow X_{12-3}^L \cup X_{13-2}^L$. Thus, using $d_L^+(X_{1-23}^L) > 0$, we get $X_{123}^L \neq \emptyset$. As $X_{123}^R \rightarrow X_{123}^L \rightarrow X_{23-1}^R \rightarrow X_{12-3}^L \rightarrow X_{123}^R$, we have $X_{123}^R = \emptyset$. Moreover $X_1^R \rightarrow X_{23-1}^R$ because $X_1^R \rightarrow X_{1-23}^L \rightarrow X_{23-1}^R$. We also have $X_{1-23}^R \rightarrow X_{13-2}^R$ as $X_{1-23}^R \rightarrow X_{123}^L \rightarrow X_{13-2}^R$. Now $V(R) \setminus Z^R = X_{1-23}^R \cup X_{13-2}^R \cup X_{23-1}^R \rightarrow X_{12-3}^L \rightarrow Z^R$. Thus $Z^R = \emptyset$ and $V(R) = X_{1-23}^R \cup X_{13-2}^R \cup X_{23-1}^R$ where each of these sets induces an acyclic digraph in R and $X_{1-23}^R \Rightarrow X_{23-1}^R \Rightarrow X_{13-2}^R \Rightarrow X_{1-23}^R$ in D . But then inverting $X_{1-23}^R \cup X_{23-1}^R$ we make R acyclic, a contradiction to $\text{inv}(R) = 2$. Thus $X_{23-1}^L \neq \emptyset$.

Therefore $X_{13-2}^L = \emptyset$ as $X_{13-2}^L \rightarrow X_{13-2}^R \rightarrow X_{23-1}^L \rightarrow X_{23-1}^R \rightarrow X_{13-2}^L$. As $X_{1-23}^L \rightarrow X_{23-1}^R \rightarrow X_{12-3}^L$ we have $X_{1-23}^L \rightarrow X_{12-3}^L$; As $X_{23-1}^L \rightarrow X_{1-23}^R \rightarrow X_{1-23}^L \cup X_{12-3}^L$ we have $X_{23-1}^L \rightarrow X_{1-23}^L \cup X_{12-3}^L$; As $X_{1-23}^R \rightarrow X_{1-23}^L \rightarrow X_{23-1}^R$ we have $X_{1-23}^R \rightarrow X_{23-1}^R$; as $X_{13-2}^R \rightarrow X_{23-1}^R \rightarrow X_{1-23}^R \cup X_{23-1}^R$ we have $X_{13-2}^R \rightarrow X_{1-23}^R \cup X_{23-1}^R$.

As every vertex in $V(R) \setminus Z^R$ has an out-neighbour in $V(L)$, we derive as above $Z^R = \emptyset$. Similarly, as every vertex in $V(L) \setminus Z^L$ has in-neighbour in $V(R)$, we get $Z^L = \emptyset$. Next observe that at least one of the sets X_{123}^R, X_{123}^L must be empty as $X_{123}^R \rightarrow X_{123}^L \rightarrow X_{23-1}^R \rightarrow X_{12-3}^L \rightarrow X_{123}^R$. If $X_{123}^R = \emptyset$ then $V(R) = X_{1-23}^R \cup X_{13-2}^R \cup X_{23-1}^R$ where each of these sets induces an acyclic subtournament of R and $X_{1-23}^R \Rightarrow X_{23-1}^R \Rightarrow X_{13-2}^R$ and $X_{1-23}^R \Rightarrow X_{13-2}^R$. Thus R is acyclic, contradicting $\text{inv}(R) = 2$. So $X_{123}^R \neq \emptyset$ and $X_{123}^L = \emptyset$. As above we obtain a contradiction by observing that L is acyclic, contradicting $\text{inv}(L) = 2$. This completes the proof of Subcase 3.1.

Subcase 3.2 $X_{1-23}^R = \emptyset$.

By symmetry, we can assume $X_{2-13}^R = \emptyset$ and $X_{3-12}^R \neq \emptyset$. Hence $X_{1-23}^L \rightarrow X_3^L$ because $X_{1-23}^L \rightarrow X_{3-12}^R \rightarrow X_3^L$, and $X_1^R \rightarrow X_{3-12}^R$ because $X_1^R \rightarrow X_{1-23}^L \rightarrow X_{3-12}^R$. Note that one of X_{13-2}^L, X_{13-2}^R is empty since $X_{13-2}^L \rightarrow X_{13-2}^R \rightarrow X_{1-23}^L \rightarrow X_{3-12}^R \rightarrow X_{13-2}^L$. By symmetry we can assume that $X_{13-2}^L = \emptyset$. By Claim C, $X_2^L \neq X_3^L$, so $X_{12-3}^L \neq \emptyset$.

Suppose first that $X_{123}^R \neq \emptyset$. Then $X_{23-1}^L = \emptyset$ since $X_{23-1}^L \rightarrow X_{123}^R \rightarrow X_{1-23}^L \rightarrow X_{23-1}^L$. Now, by Claim A, $X_3^L \neq \emptyset$ so $X_{123}^L \neq \emptyset$. Now $X_{123}^L \rightarrow X_{13-2}^R \rightarrow X_{1-23}^L \rightarrow X_{123}^L$, so $X_{13-2}^R = \emptyset$. Furthermore, $X_{23-1}^R \rightarrow X_{12-3}^L \rightarrow X_{123}^R \rightarrow X_{1-23}^L \rightarrow X_{23-1}^R$ so $X_{23-1}^R = \emptyset$. Therefore $X_1^R = X_2^R$, a contradiction to Claim C. Thus $X_{123}^R = \emptyset$.

Next suppose $X_{123}^L \neq \emptyset$. Then $X_{12-3}^R = \emptyset$ because $X_{12-3}^R \rightarrow X_{3-12}^R \rightarrow X_{123}^L \rightarrow X_{12-3}^R$. By Claim A, $X_1^R, X_2^R \neq \emptyset$, so $X_{13-2}^R \neq \emptyset$ and $X_{23-1}^R \neq \emptyset$. As $X_{13-2}^R \rightarrow X_{1-23}^L \rightarrow X_{3-12}^R \cup X_{23-1}^R$ we have $X_{13-2}^R \rightarrow X_{3-12}^R \cup X_{23-1}^R$.

Since $d_R^+(X_{13-2}^R) > 0$ we have $Z^R \neq \emptyset$. However, there can be no arcs from Z^R to $X_3^R = V(R) \setminus Z^R$, because $X_3^R \rightarrow X_{123}^L \rightarrow Z^R$. This contradicts the fact that R is strong. Thus $X_{123}^L = \emptyset$.

By Claim A, $X_3^L \neq \emptyset$, so $X_{23-1}^L \neq \emptyset$. Thus $X_{23-1}^R = \emptyset$ because $X_{23-1}^R \rightarrow X_{12-3}^L \rightarrow X_{3-12}^R \rightarrow X_{23-1}^L \rightarrow X_{23-1}^R$. By Claim A, $X_2^R \neq \emptyset$ so $X_{12-3}^R \neq \emptyset$. By Claim C, $X_1^R \neq X_2^R$, so $X_{13-2}^R \neq \emptyset$. As $X_{12-3}^L \rightarrow X_{12-3}^R \rightarrow X_{1-23}^L \cup X_{23-1}^L$, we have $X_{12-3}^L \rightarrow X_{1-23}^L \cup X_{23-1}^L$. Thus the fact that $d_L^+(X_{12-3}^L) > 0$ implies that there is an arc vz from X_{12-3}^L to Z^L . But then for any $u \in X_{13-2}^R$, (u, v, z, u) is directed 3-cycle, a contradiction.

This completes Subcase 3.2.

Case 4: All three of $X_{1-23}^L, X_{2-13}^L, X_{3-12}^L$ or all three of $X_{1-23}^R, X_{2-13}^R, X_{3-12}^R$ are non-empty.

By symmetry, we can assume that $X_{1-23}^L, X_{2-13}^L, X_{3-12}^L \neq \emptyset$. There do not exist $i, j \in [3]$ such that $X_i^R \setminus X_j^R, X_j^R \setminus X_i^R \neq \emptyset$, for otherwise $X_{i-jk}^L \rightarrow (X_j^R \setminus X_i^R) \rightarrow X_{j-ik}^L \rightarrow (X_i^R \setminus X_j^R) \rightarrow X_{i-jk}^L$, a contradiction. Hence we may assume by symmetry that $X_3^R \setminus X_1^R, X_3^R \setminus X_2^R, X_2^R \setminus X_3^R = \emptyset$. This implies that $X_2^R = X_{123}^R, X_3^R = X_{123}^R \cup X_{13-2}^R$ and $X_1^R = X_{123}^R \cup X_{13-2}^R \cup X_{1-23}^R$. Moreover, $X_{1-23}^R, X_{123}^R, X_{13-2}^R \neq \emptyset$ by Claim C. As $X_3^R \rightarrow X_{3-12}^L \rightarrow X_{1-23}^R$ we have $X_3^R \rightarrow X_{1-23}^R$, so since $d_R^-(X_{1-23}^R) > 0$ we must have an arc from Z^R to X_{1-23}^R and now $X_{1-23}^R \rightarrow X_{1-23}^L \rightarrow Z^R$ gives a contradiction. This completes Case 4.

Case 5: Exactly two of $X_{1-23}^L, X_{2-13}^L, X_{3-12}^L$ or two of $X_{1-23}^R, X_{2-13}^R, X_{3-12}^R$ are non-empty.

By symmetry we can assume that $X_{1-23}^L, X_{2-13}^L \neq \emptyset$ and $X_{3-12}^L = \emptyset$.

Subcase 5.1: $X_{1-23}^R, X_{2-13}^R, X_{3-12}^R = \emptyset$.

As $X_{1-23}^L \rightarrow X_{23-1}^R \rightarrow X_{2-13}^L \rightarrow X_{13-2}^R \rightarrow X_{1-23}^L$, one of X_{13-2}^R, X_{23-1}^R is empty. By symmetry we may assume that $X_{23-1}^R = \emptyset$. By Claim C, $X_1^R \neq X_2^R$ and $X_1^R \neq X_3^R$, so $X_{13-2}^R \neq \emptyset$ and $X_{12-3}^R \neq \emptyset$. Now $V(R) \setminus Z^R = X_1^R \rightarrow X_{1-23}^L \rightarrow Z^R$, thus there is no arc leaving Z^R . As R is strong, we get $Z^R = \emptyset$.

As $X_{12-3}^R \rightarrow X_{2-13}^L \rightarrow X_{13-2}^R$, we have $X_{12-3}^R \rightarrow X_{13-2}^R$. Hence as R is strong, necessarily $X_{123}^R \neq \emptyset$. If $X_{123}^L \neq \emptyset$, then $X_{123}^R \rightarrow X_{12-3}^R \cup X_{13-2}^R$ as $X_{123}^R \rightarrow X_{123}^L \rightarrow X_{12-3}^R \cup X_{13-2}^R$. This contradicts the fact that R is strong since $d_R^+(X_{123}^R) = 0$. Hence $X_{123}^L = \emptyset$. By Claim A, $X_3^L \neq \emptyset$, so $X_{13-2}^L \cup X_{23-1}^L \neq \emptyset$.

Since $X_{123}^R \rightarrow X_{2-13}^L \rightarrow X_{13-2}^R$, we have $X_{123}^R \rightarrow X_{13-2}^R$. We also have $X_{12-3}^R \rightarrow X_{123}^R$ because $X_{12-3}^R \rightarrow X_{13-2}^L \cup X_{23-1}^L \rightarrow X_{123}^R$. Hence $V(R) = X_{12-3}^R \cup X_{13-2}^R \cup X_{123}^R$ where each of these sets induces an acyclic subtournament of R and $X_{13-2}^R \Rightarrow X_{12-3}^R \Rightarrow X_{123}^R \Rightarrow X_{13-2}^R$. Thus inverting $X_{12-3}^R \cup X_{13-2}^R$ makes R acyclic, contradicting $\text{inv}(R) = 2$.

This completes Subcase 5.1

Subcase 5.2: $X_{1-23}^R \neq \emptyset$ and $X_{2-13}^R \cup X_{3-12}^R = \emptyset$.

We first observe that since $X_{2-13}^L \cup X_{23-1}^L \rightarrow X_{1-23}^R \rightarrow X_1^L$ we can conclude that $X_{2-13}^L \rightarrow X_1^L$ and $X_{23-1}^L \rightarrow X_1^L$. As $X_{23-1}^R \rightarrow X_{2-13}^L \rightarrow X_{1-23}^R \rightarrow X_{23-1}^R$, we have $X_{23-1}^R = \emptyset$. Now $V(R) \setminus Z^R = X_1^R$ and $X_1^R \rightarrow X_{1-23}^L \rightarrow Z^R$. So $V(R) \setminus Z^R \rightarrow Z^R$. Since R is strong, $Z^R = \emptyset$. Now Claims A and C imply that at least two of the sets $X_{13-2}^R, X_{123}^R, X_{12-3}^R$ are non-empty. This implies that every vertex of $V(L)$ has an in-neighbour in $V(R)$ (as $X_{1-23}^R \rightarrow X_1^L, X_{13-2}^R \cup X_{12-3}^R \rightarrow X_{23-1}^L$ and $X_2^R \rightarrow X_{2-13}^L$) so we must have $Z^L = \emptyset$.

Suppose first that $X_{12-3}^R = \emptyset$. By Claim A, $X_2^R \neq \emptyset$, so $X_{123}^R \neq \emptyset$. Moreover, by Claim C, $X_2^R \neq X_3^R$, so $X_{13-2}^R \neq \emptyset$. Since $X_{12-3}^L \cup X_{13-2}^L \rightarrow X_{123}^R \rightarrow X_{2-13}^L \rightarrow X_{12-3}^L \cup X_{13-2}^L$ we have $X_{12-3}^L \cup X_{13-2}^L = \emptyset$. If $X_{23-1}^L \neq \emptyset$, then $X_{123}^L = \emptyset$ as $X_{23-1}^L \rightarrow X_{123}^L \rightarrow X_{13-2}^R \rightarrow X_{23-1}^L$ and we have $X_{2-13}^L \rightarrow X_{23-1}^L$ as $X_{2-13}^L \rightarrow X_{13-2}^R \rightarrow X_{23-1}^L$. Now we see that $d_L^-(X_{23-1}^L) = 0$, a contradiction. Hence $X_{23-1}^L = \emptyset$ and $X_{123}^L \neq \emptyset$ because $X_3^L \neq \emptyset$ by Claim A. Moreover $X_{123}^L \rightarrow X_{1-23}^R$ because $X_{123}^L \rightarrow X_{13-2}^R \rightarrow X_{1-23}^R$. Now $V(L) = X_{1-23}^L \cup X_{2-13}^L \cup X_{123}^L$ where each of these sets induces an acyclic subdigraph in L and $X_{1-23}^L \Rightarrow X_{123}^L \Rightarrow X_{2-13}^L \Rightarrow X_{1-23}^L$. Then inverting the set

$X_{1-23}^L \cup X_{2-13}^L$ makes L acyclic, a contradiction to $\text{inv}(L) = 2$. Thus $X_{12-3}^R \neq \emptyset$.

Note that $X_{12-3}^R \rightarrow X_{1-23}^R \cup X_{13-2}^R$ as $X_{12-3}^R \rightarrow X_{2-13}^L \rightarrow X_{1-23}^R \cup X_{13-2}^R$. Thus $X_{123}^L = \emptyset$ because $X_{123}^L \rightarrow X_{12-3}^R \rightarrow X_{1-23}^R \rightarrow X_{123}^L$. Furthermore the fact that $d_R^+(X_{12-3}^R) > 0$ implies that $X_{123}^R \neq \emptyset$ and that there is at least one arc from X_{12-3}^R to X_{123}^R in T (and in R). We saw before that $X_{12-3}^R \rightarrow X_{1-23}^R$ and by the same reasoning $X_{123}^R \rightarrow X_{1-23}^R$, hence, as $Z^R = \emptyset$ and $d_R^-(X_{1-23}^R) > 0$, there is at least one arc from X_{1-23}^R to X_{13-2}^R . Hence $X_{13-2}^R \neq \emptyset$ and $X_{23-1}^R = \emptyset$ as $X_{13-2}^R \rightarrow X_{23-1}^L \rightarrow X_{1-23}^R$. We have $X_{12-3}^L = \emptyset$ since $X_{12-3}^L \rightarrow X_{123}^R \rightarrow X_{2-13}^L \rightarrow X_{1-23}^R \rightarrow X_{12-3}^L$. Finally, as $X_{2-13}^L \rightarrow X_{1-23}^R \rightarrow X_1^L$ we have $X_{2-13}^L \rightarrow X_1^L$. But now $d_L^+(X_1^L) = 0$ (recall that $Z^L = \emptyset$), a contradiction. This completes Subcase 5.2

Subcase 5.3: $X_{3-12}^R \neq \emptyset$ and $X_{1-23}^R \cup X_{2-13}^R = \emptyset$.

As $X_{23-1}^R \rightarrow X_{2-13}^L \rightarrow X_{13-2}^R \rightarrow X_{1-23}^L \rightarrow X_{23-1}^R$ one of the sets X_{13-2}^R, X_{23-1}^R must be empty. By symmetry we may assume that $X_{23-1}^R = \emptyset$.

Suppose first that $X_{12-3}^R = \emptyset$. Then, by Claim A, $X_2^R \neq \emptyset$, so $X_{123}^R \neq \emptyset$, and by Claim C, $X_1^R \neq X_2^R$, so $X_{13-2}^R \neq \emptyset$. Now $X_{123}^L = \emptyset$ because $X_{123}^L \rightarrow X_{13-2}^R \rightarrow X_{1-23}^L \rightarrow X_{3-12}^R \rightarrow X_{123}^L$. As $X_{123}^R \rightarrow X_{2-13}^L \rightarrow X_{13-2}^R \cup X_{3-12}^R$, we have $X_{123}^R \rightarrow X_{13-2}^R \cup X_{3-12}^R$. Next we observe that $X_{13-2}^L = \emptyset$ since $X_{13-2}^L \rightarrow X_{123}^R \rightarrow X_{3-12}^R \rightarrow X_{13-2}^L$. Now, as $X_3^L \neq \emptyset$ by Claim C, we have $X_{23-1}^L \neq \emptyset$ but that contradicts that $X_{23-1}^L \rightarrow X_{123}^R \rightarrow X_{3-12}^R \rightarrow X_{23-1}^L$. So we must have $X_{12-3}^R \neq \emptyset$.

First observe that $X_{123}^L = \emptyset$ as $X_{123}^L \rightarrow X_{12-3}^R \rightarrow X_{1-23}^L \rightarrow X_{3-12}^R \rightarrow X_{123}^L$. As $X_1^R \neq X_2^R$ by Claim C, we have $X_{13-2}^R \neq \emptyset$. Now $X_{13-2}^L = \emptyset$ as $X_{13-2}^L \rightarrow X_{13-2}^R \rightarrow X_{1-23}^L \rightarrow X_{3-12}^R \rightarrow X_{13-2}^L$. As $X_3^L \neq \emptyset$ by Claim A, we have $X_{23-1}^L \neq \emptyset$. Since $X_{12-3}^R \rightarrow X_{12-3}^L \rightarrow X_{2-13}^L \rightarrow X_{13-2}^R \rightarrow X_{12-3}^R$ we have $X_{12-3}^L = \emptyset$. As $X_{1-23}^L \rightarrow X_{3-12}^R \rightarrow X_{23-1}^L$, we have $X_{1-23}^L \rightarrow X_{23-1}^L$. Moreover $X_{2-13}^L \rightarrow X_{13-2}^R \rightarrow X_{23-1}^L \cup X_{1-23}^L$ implies $X_{2-13}^L \rightarrow X_{23-1}^L \cup X_{1-23}^L$. We also have $Z^L = \emptyset$ since every vertex in $X_{1-23}^L \cup X_{23-1}^L \cup X_{2-13}^L$ has an in-neighbour in R , implying that there can be no arc entering Z^L . Now $V(L) = X_{1-23}^L \cup X_{23-1}^L \cup X_{2-13}^L$ where each of these sets induces a transitive subtournament in L and $X_{1-23}^L \Rightarrow X_{23-1}^L \Rightarrow X_{2-13}^L \Rightarrow X_{1-23}^L$. However this implies that inverting $X_{1-23}^L \cup X_{2-13}^L$ makes L acyclic, a contradiction to $\text{inv}(L) = 2$. This completes the proof of Subcase 5.3.

Subcase 5.4: $X_{1-23}^R, X_{2-13}^R \neq \emptyset$ and $X_{3-12}^R = \emptyset$.

This case is trivial as $X_{1-23}^L \rightarrow X_{2-13}^R \rightarrow X_{2-13}^L \rightarrow X_{1-23}^R \rightarrow X_{1-23}^L$ contradicts that T is acyclic.

By symmetry the only remaining case to consider is the following.

Subcase 5.5: $X_{1-23}^R, X_{3-12}^R \neq \emptyset$ and $X_{2-13}^R = \emptyset$.

As $X_{23-1}^L \rightarrow X_{1-23}^R \rightarrow X_{1-23}^L \rightarrow X_{3-12}^R \rightarrow X_{23-1}^L$ we have $X_{23-1}^L = \emptyset$ and as $X_{23-1}^R \rightarrow X_{2-13}^L \rightarrow X_{1-23}^R \rightarrow X_{1-23}^L \rightarrow X_{23-1}^R$ we have $X_{23-1}^R = \emptyset$. Note that every vertex in $V(L)$ has an in-neighbour in $V(R)$ (as $X_{1-23}^R \rightarrow X_{1-23}^L$ and $X_2^R \rightarrow X_{2-13}^L$) and every vertex in $V(R)$ has an out-neighbour in $V(L)$ (as $X_1^R \rightarrow X_{1-23}^L$ and $X_{3-12}^R \rightarrow X_3^L$). This implies that $Z^L = \emptyset$ and $Z^R = \emptyset$. At least one of X_{13-2}^L, X_{13-2}^R is empty as $X_{13-2}^L \rightarrow X_{13-2}^R \rightarrow X_{1-23}^L \rightarrow X_{3-12}^R \rightarrow X_{13-2}^L$ and at least one of X_{12-3}^L, X_{12-3}^R is empty as $X_{12-3}^L \rightarrow X_{12-3}^R \rightarrow X_{2-13}^L \rightarrow X_{1-23}^R \rightarrow X_{12-3}^L$.

Suppose first that $X_{12-3}^R = \emptyset = X_{13-2}^R$. Then $X_2^R \neq \emptyset$ by Claim A, so $X_{123}^R \neq \emptyset$.

Moreover $X_{123}^R \rightarrow X_{1-23}^R \cup X_{3-12}^R$ because $X_{123}^R \rightarrow X_{2-13}^L \rightarrow X_{1-23}^R \cup X_{3-12}^R$. This implies that $d_R^+(X_{123}^R) = 0$, a contradiction.

Suppose next that $X_{12-3}^L = \emptyset = X_{13-2}^L$. Then $X_3^L \neq \emptyset$ by Claim A, so $X_{123}^L \neq \emptyset$. Moreover $X_{1-23}^L \cup X_{2-13}^L \rightarrow X_{123}^L$ as $X_{1-23}^L \cup X_{2-13}^L \rightarrow X_{3-12}^R \rightarrow X_{123}^L$. This implies that $d_L^-(X_{123}^L) = 0$, a contradiction.

Now assume that $X_{12-3}^R = \emptyset = X_{13-2}^L$ and $X_{13-2}^R \neq \emptyset \neq X_{12-3}^L$. Then $X_{123}^L \neq \emptyset$ as $X_3^L \neq \emptyset$ by Claim A and now we get the contradiction $X_{123}^L \rightarrow X_{13-2}^R \rightarrow X_{1-23}^L \rightarrow X_{3-12}^R \rightarrow X_{123}^L$.

The final case is $X_{12-3}^R \neq \emptyset \neq X_{13-2}^L$ and $X_{13-2}^R = \emptyset = X_{12-3}^L$. We first observe that $X_{123}^R = \emptyset$ as $X_{123}^R \rightarrow X_{1-23}^L \rightarrow X_{3-12}^R \rightarrow X_{13-2}^L \rightarrow X_{123}^R$. As $X_{12-3}^R \rightarrow X_{2-13}^L \rightarrow X_{1-23}^R$ we have $X_{12-3}^R \rightarrow X_{1-23}^R$ and as $X_{1-23}^R \rightarrow X_{1-23}^L \rightarrow X_{3-12}^R$ we have $X_{1-23}^R \rightarrow X_{3-12}^R$. This implies that $d_R^-(X_{1-23}^R) = 0$, a contradiction. This completes Subcase 5.5 and the proof of the theorem. □

TACKLING SCALABILITY ISSUES IN MINING PATH PATTERNS FROM KNOWLEDGE GRAPHS: A PRELIMINARY STUDY*

Pierre Monnin

Université de Lorraine, CNRS, Inria, LORIA
F-54000 Nancy, France
pierre.monnin@loria.fr

Emmanuel Bresso

Université de Lorraine, CNRS, Inria, LORIA
F-54000 Nancy, France
emmanuel.bresso@loria.fr

Miguel Couceiro

Université de Lorraine, CNRS, Inria, LORIA
F-54000 Nancy, France
miguel.couceiro@loria.fr

Malika Smail-Tabbone

Université de Lorraine, CNRS, Inria, LORIA
F-54000 Nancy, France
malika.smail@loria.fr

Amedeo Napoli

Université de Lorraine, CNRS, Inria, LORIA
F-54000 Nancy, France
amedeo.napoli@loria.fr

Adrien Coulet

Université de Lorraine, CNRS, Inria, LORIA
F-54000 Nancy, France
adrien.coulet@loria.fr

ABSTRACT

Features mined from knowledge graphs are widely used within multiple knowledge discovery tasks such as classification or fact-checking. Here, we consider a given set of vertices, called *seed vertices*, and focus on mining their associated *neighboring vertices*, *paths*, and, more generally, *path patterns* that involve classes of ontologies linked with knowledge graphs. Due to the combinatorial nature and the increasing size of real-world knowledge graphs, the task of mining these patterns immediately entails scalability issues. In this paper, we address these issues by proposing a pattern mining approach that relies on a set of constraints (*e.g.*, support or degree thresholds) and the *monotonicity* property. As our motivation comes from the mining of real-world knowledge graphs, we illustrate our approach with PGxLOD, a biomedical knowledge graph.

Keywords Path · Path Pattern · Ontology · Knowledge Graph · Scalability

1 Introduction

Knowledge graphs [1] have a central role in knowledge discovery tasks. For example, Linked Open Data [2] have been used in all steps of the knowledge discovery process [3]. In particular, features mined from knowledge graphs have been used in multiple applications such as knowledge base completion [4], explanations [5], or fact-checking [6]. Here, we focus on knowledge graphs expressed using Semantic Web standards [7]. In this context, *vertices* are either individuals that represent entities of a world (*e.g.*, places, drugs, etc.), literals (*e.g.*, integers, dates, etc.), or classes of individuals (*e.g.*, Person, Drug, etc.). *Arcs* are defined by triples $\langle \text{subject}, \text{predicate}, \text{object} \rangle$ in the Resource Description Format language. Such a triple states that the subject is linked to the object by a relationship qualified by the predicate (*e.g.*, *has-side-effect*, *has-name*, etc.). Classes and predicates are defined in ontologies, *i.e.*, formal representations of a domain [8], and organized into two hierarchies ordered by the subsumption relation. In Semantic Web standards, individuals, classes, and predicates are identified by a Uniform Resource Identifier (URI). We view such a knowledge graph as a directed labeled multigraph $\mathcal{K} = (\Sigma_V, \Sigma_A, V, A, s, t, \ell_V, \ell_A)$, where

*Supported by the *PractiKPharma* project, founded by the French National Research Agency (ANR) under Grant ANR15-CE23-0028, and by the *Snowball* Inria Associate Team.

- V is the set of vertices.
- A is the set of arcs connecting vertices through predicates².
- Σ_V is the set of vertex labels, here, their URI³.
- Σ_A is the set of arc labels, here, URIs of predicates of \mathcal{K} .
- $s : A \rightarrow V$ (respectively $t : A \rightarrow V$) associates an arc to its source (respectively target) vertex.
- $\ell_V : V \rightarrow \Sigma_V$ (respectively $\ell_A : A \rightarrow \Sigma_A$) maps a vertex (respectively an arc) to its label.

Hence, a triple $\langle s, p, o \rangle$ is represented by two vertices $v_s, v_o \in V$ and an arc $a_{\langle s, p, o \rangle} \in A$. The source and target vertices of $a_{\langle s, p, o \rangle}$ are respectively v_s and v_o , *i.e.*, $s(a_{\langle s, p, o \rangle}) = v_s$ and $t(a_{\langle s, p, o \rangle}) = v_o$. The labels of v_s, v_o , and $a_{\langle s, p, o \rangle}$ are respectively s, o , and p , *i.e.*, $\ell_V(v_s) = s$, $\ell_V(v_o) = o$, and $\ell_A(a_{\langle s, p, o \rangle}) = p$.

In this work, we consider the task of mining features from \mathcal{K} that are associated with a set of vertices of interest, which we call *seed vertices*. The set of seed vertices can be defined in intension (*i.e.*, all vertices that instantiate a specified ontology class) or in extension (*i.e.*, by specifying the list of their URIs). For example, in the biomedical domain, an expert may be interested in mining features associated with vertices that represent drugs causing a specific side effect. We propose to mine from \mathcal{K} the three following kinds of features: *neighboring vertices*, *paths*, and *path patterns*.

Neighboring vertices are vertices that can be reached in \mathcal{K} from at least one seed vertex. A neighbor is associated with all seed vertices from which it is reachable. Its *support* counts such seed vertices. For example, in the knowledge graph depicted in Figure 1, the neighbor v_6 is reachable from the seed vertices n_1^C and n_2^C , and thus its support is 2.

Paths are sequences of pairs $\xrightarrow{p} e$ that represent an arc labeled by the predicate p incident to an individual e . A path is associated with all seed vertices that root it in \mathcal{K} . The *support* of a path counts such seed vertices. For example, the support of $\xrightarrow{p_1} v_2 \xrightarrow{p_2} v_3$ is 1 since only n_1^C root it, *i.e.*, $n_1^C \xrightarrow{p_1} v_2 \xrightarrow{p_2} v_3$ exists in \mathcal{K} .

More generally, paths may share several characteristics. For instance, intermediate vertices in paths may instantiate the same ontology classes. We propose to capture these characteristics by considering *path patterns* in addition to paths. Path patterns are sequences of pairs $\xrightarrow{p} E$, where p is a predicate and E is either an individual or a class. Such a pair indicates that an arc labeled by p is incident to (i) E if E is an individual or (ii) an individual that instantiates E if E is a class. A path pattern is associated with all seed vertices that root a path captured by the path pattern. Its *support* counts such seed vertices. In the example graph depicted in Figure 1, v_2 instantiates T_1 , and v_3 instantiates T_2 . Thus, $\xrightarrow{p_1} v_2 \xrightarrow{p_2} v_3$ is captured by $\xrightarrow{p_1} T_1 \xrightarrow{p_2} v_3$, $\xrightarrow{p_1} v_2 \xrightarrow{p_2} T_2$, and $\xrightarrow{p_1} T_1 \xrightarrow{p_2} T_2$. Since T_2 is a subclass of T_3 , it is also captured by the pattern $\xrightarrow{p_1} T_1 \xrightarrow{p_2} T_3$. Note that $\xrightarrow{p_1} T_1 \xrightarrow{p_2} T_3$ also captures $\xrightarrow{p_1} v_4 \xrightarrow{p_2} v_5$, which is rooted by n_2^C . Consequently, the support of $\xrightarrow{p_1} T_1 \xrightarrow{p_2} T_3$ is 2. This illustrates the fact that path patterns may capture additional common characteristics of seed vertices, and thus interestingly complete paths. Mining these patterns constitutes a challenging task due to the combinatorial nature and the size of real-world knowledge graphs, which naturally entail scalability issues. For example, $\xrightarrow{p_1} v_2 \xrightarrow{p_2} v_3$ can be generalized by up to 11 path patterns.

This mining task and its inherent scalability issues constitute the main concerns of the present work. To the best of our knowledge, works available in the literature do not address such issues in knowledge graphs with the adopted granular modeling of path patterns. However, inspired by existing graph mining works [9], we propose an Apriori-based approach that alleviates these scalability issues by relying on (i) a set of constraints (*e.g.*, support or degree thresholds), (ii) the hierarchy of ontology classes, (iii) an incremental expansion of paths and patterns, and (iv) the monotonic character of the support of paths and patterns. We provide a reusable implementation on GitHub⁴.

The remainder of this paper is organized as follows. In Section 2, we outline related works that motivated our proposed approach. In Section 3, we present in details our approach to mine paths and path patterns, and discuss how it tackles scalability issues. We illustrate our framework in Section 4 on PGxLOD, a real-world biomedical knowledge graph [10]. We comment on our results as well as indicate directions of future work in Sections 5 and 6.

2 Related work

Path patterns have been widely studied in different settings, for example graph rewriting [11] and query answering [12]. Here, we recall some works that tackle the problem of mining path patterns from knowledge graphs in different application contexts.

²Here, we discard literals from V and arcs that are incident to literals from A .

³Hence, $|\Sigma_V| = |V|$.

⁴<https://github.com/pmonnin/kgpm>

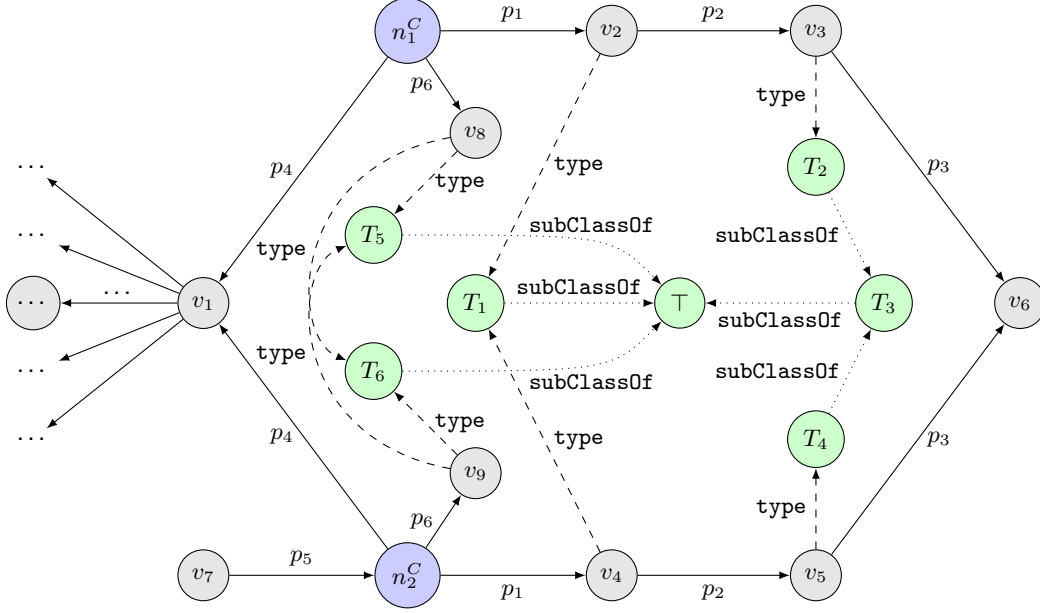

Figure 1: Example of a canonical graph \mathcal{K}^C . n_1^C and n_2^C are canonical seed vertices, all v_i are canonical individuals, and all T_i are canonical ontology classes. Prefixes of URIs were omitted for readability purposes. The definition of “canonical” is given in Subsection 3.1.

One major work dealing with feature mining from RDF graphs focuses on graph kernels that count common substructures (*i.e.*, walks, subtrees) [13, 14]. To avoid an explosion in the number of features, the authors remove patterns with a low or high frequency [14]. Graph features can be used in various tasks such as knowledge base completion. For example, AMIE [15] mines Horn clauses, *i.e.*, conjunction of triples, to predict another triple. Similarly, in Context Path Model [16], the authors model paths as sequences of predicates between the source and target entities, *i.e.*, $s \xrightarrow{p_1} \xrightarrow{p_2} \dots \xrightarrow{p_{k-1}} \xrightarrow{p_k} t$. Here, a triple is predicted based on the paths existing between the involved entities. Shi and Weninger [6] also model paths as sequences of predicates but they use them from a fact checking perspective. They check whether a triple $s \xrightarrow{p} t$ is true by predicting it from a set of learned discriminative paths $\mathbf{o}_s \xrightarrow{p_1} \xrightarrow{p_2} \dots \xrightarrow{p_{k-1}} \xrightarrow{p_k} \mathbf{o}_t$, where \mathbf{o}_s and \mathbf{o}_t are respectively the set of classes instantiated by s and t . Our framework differs from the previous two as we aim at mining features by exploring the graph from the given seed vertices and we model path patterns using the intermediate entities and the ontology classes that they instantiate.

Our motivation also comes from explainable approaches that rely on the descriptive power of features mined from knowledge graphs. For example, Explain-a-LOD [5] enriches statistical data sets with features from DBpedia. When correlations can be established between statistics and DBpedia features, these features can be used as explanations for the original statistics. For example, the quality of living in cities has been correlated with whether these cities are European capitals. Explain-a-LOD leverages the different outputs of FeGeLOD [17], some of which corresponding to our approach. For instance, the so called *relations* $\xrightarrow{p} e$ are paths, whereas the so called *qualified relations* $\xrightarrow{p} t$, where e is replaced by a class t instantiated by e , are path patterns. Alternatively, Vandewiele *et al.* [18] propose to learn a decision tree to classify entities based on paths of a knowledge graph. The authors suggest that the predictions of their model are explainable as they are obtained by a “white-box” model (*i.e.*, the decision tree) that combines interpretable features (*i.e.*, paths from a knowledge graph). Interestingly, this system considers paths with their intermediate predicates and entities, *i.e.*, $\text{root} \xrightarrow{p_1} e_1 \dots \xrightarrow{p_k} e_k$. They allow a generalization of both predicates and entities by the use of a wildcard (*). In our context, this would correspond to generalizing entities by the top level ontology class \top . However, unlike their framework, we do not generalize predicates. In their study, they focus on paths of the form $\text{root} \xrightarrow{*} * \dots \xrightarrow{*} e$, which somewhat corresponds to extracting neighbors and their distance from seed vertices.

Finally, path patterns are somewhat similar to *generalized association rules* [19] and the concept of *raising* [20]. Indeed, both works replace entities in rules by ontology classes to increase the support while preserving a high confidence. Inspired by works that prune redundant generalized rules [21], our approach mines paths and path patterns that are non-redundant and comply with some given constraints.

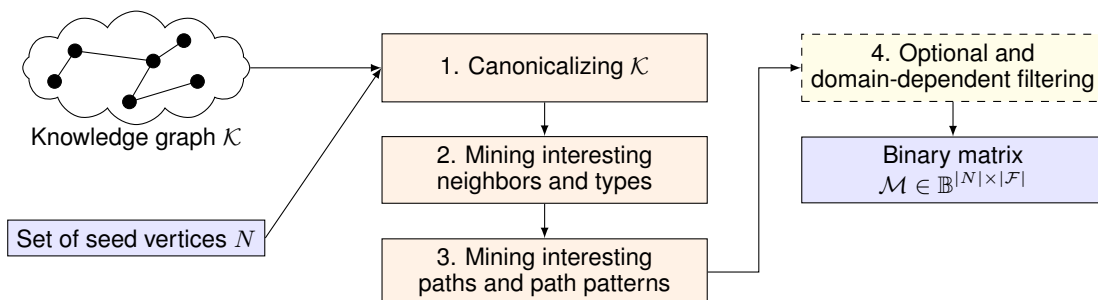

Figure 2: Main steps to mine a set \mathcal{F} of features (*i.e.*, neighbors, paths, and path patterns) associated with a set N of seed vertices from a knowledge graph \mathcal{K} . Step 4 is optional and depends on the application domain.

Table 1: Parameters that configure the mining of interesting neighbors, paths, and path patterns in a knowledge graph \mathcal{K} . Each parameter is associated with a domain and is used in specific steps (see Figure 2 for step numbers). Parameter m is specific to the considered application. Here, we illustrate the role of m with the biomedical domain.

Parameter	Domain	Steps	Description
k	\mathbb{N}^+	2, 3	Maximum length of paths and path patterns
t	\mathbb{N}	3	Maximum level for generalization in class hierarchies
d	\mathbb{N}	2, 3	Maximum degree ($u = \text{true}$) or out degree ($u = \text{false}$) to allow expansion
l_{\min}	\mathbb{N}	2, 3	Minimum support for features
l_{\max}	\mathbb{N}	2, 3	Maximum support for features
u	\mathbb{B}	2, 3	Whether only out arcs ($u = \text{false}$) or all arcs ($u = \text{true}$) are traversed
$b_{\text{predicates}}$	List of URIs	2, 3	Blacklist of predicates not to traverse
$b_{\text{exp-types}}$	List of URIs	2, 3	Blacklist of classes whose instances are not to reach
$b_{\text{gen-types}}$	List of URIs	2, 3	Blacklist of classes not to use in generalization
m	$\{\text{none}, \text{p}, \text{g}, \text{m}, \text{pg}, \text{pgm}\}$	4	Optional and domain-dependent filtering strategy <i>Illustrated here with the biomedical domain</i>

3 Towards a scalable approach to mine interesting paths and path patterns

In this paper, we consider a knowledge graph \mathcal{K} and a set of seed vertices $N = \{n_1, n_2, \dots, n_p\} \subseteq V$. The task is to mine neighbors, paths, and path patterns from \mathcal{K} that are associated with these seed vertices. For example, given a set of drugs that cause or not a side effect, we aim to mine features that can later be used to classify these drugs.

In the following subsections, we propose algorithms to build a binary matrix \mathcal{M} of size $|N| \times |\mathcal{F}|$ from the knowledge graph \mathcal{K} and the set of seed vertices N . The set \mathcal{F} consists of *interesting* neighbors, paths, and path patterns mined from \mathcal{K} , *i.e.*, neighbors, paths, and path patterns that satisfy the constraints defined in terms of the parameters summarized in Table 1. These parameters will be detailed in the following subsections. \mathcal{M} associates a seed vertex $n \in N$ with its features $f \in \mathcal{F}$, *i.e.*, if $\mathcal{M}_{n,f} = \text{true}$, then n has feature f . We outline our approach in Figure 2 where steps 1, 2, and 3 are mandatory, while step 4 is optional and depends on the application domain.

3.1 Canonicalizing \mathcal{K}

The first step of our approach consists in *canonicalizing* the knowledge graph \mathcal{K} , *i.e.*, unifying vertices that represent the same real-world entity. We use the *canonicalization* word by analogy with the canonicalization of knowledge bases, which consists in unifying equivalent individuals into one [4]. Indeed, in knowledge bases under the Open Information Extraction paradigm, facts and entities can be represented by synonymous terms, which leads to co-existing and equivalent individuals. For example, in such knowledge bases, two individuals *Obama* and *Barack Obama* can co-exist. Similarly, in \mathcal{K} , vertices can be connected through arcs labeled by the `owl:sameAs` predicate, indicating that these vertices are actually representing the same real-world entity.

Such a situation typically arises when \mathcal{K} comprises several data sets. For example, a drug can be represented by two vertices linked by an `owl:sameAs` arc, resulting from the information extraction of two independent drug-related databases. Therefore, their merging allows an easy access to the full extent of the knowledge in \mathcal{K} about the drug they

represent. Such a canonicalization process corresponds to edge contraction in graph theory (*i.e.*, taking graph quotient). In our framework, it reduces to contracting arcs whose label is the `owl:sameAs` predicate.

To perform this canonicalization, we must respect the semantics associated with the `owl:sameAs` predicate, and thus take into account its symmetry and transitivity. Indeed, an `owl:sameAs` arc between two vertices either is explicitly stated in \mathcal{K} or follows from existing arcs and these two properties. Let us consider a vertex v in \mathcal{K} . The canonicalization step merges v with all its identical vertices based on `owl:sameAs` arcs. To compute this set of vertices, it suffices to compute the connected component of v in the undirected spanning subgraph formed by the `owl:sameAs` arcs of \mathcal{K} . Indeed, undirected edges comply with the symmetry of `owl:sameAs` and connected components comply with the transitivity of `owl:sameAs`.

As a result, this step takes \mathcal{K} as input and outputs its *canonical* graph $\mathcal{K}^C = (\Sigma_V^C, \Sigma_A^C, V^C, A^C, s^C, t^C, \ell_V^C, \ell_A^C)$. Similarly to \mathcal{K} , \mathcal{K}^C is a directed labeled multigraph where

- V^C is the set of canonical vertices.
- A^C is the set of canonical arcs connecting canonical vertices through predicates.
- Σ_V^C is the set of canonical vertex labels.
- Σ_A^C is the set of canonical arc labels.
- $s^C : A^C \rightarrow V^C$ (respectively $t^C : A^C \rightarrow V^C$) associates a canonical arc to its canonical source (respectively target) vertex.
- $\ell_V^C : V^C \rightarrow \Sigma_V^C$ (respectively $\ell_A^C : A^C \rightarrow \Sigma_A^C$) maps a canonical vertex (respectively a canonical arc) to its label.

Each canonical vertex in \mathcal{K}^C represents a vertex from \mathcal{K} and all its identical vertices. It is possible for a canonical vertex in \mathcal{K}^C to only represent one vertex v from \mathcal{K} if v has no identical vertices. This corresponds to creating a surjective mapping $\lambda : V \rightarrow V^C$ associating a vertex from \mathcal{K} to its equivalent canonical vertex in \mathcal{K}^C . Canonical arcs in \mathcal{K}^C are constructed by using λ to map the source and target vertices of arcs in \mathcal{K} to canonical vertices. Similarly, the set of seed vertices N is mapped to the set of canonical seed vertices, denoted by N^C .

Remark 1. Note that storing URIs has a high memory footprint. Thus, in \mathcal{K}^C , we use indices in \mathbb{N} instead of URIs to label vertices and arcs, *i.e.*, $\Sigma_V^C \subseteq \mathbb{N}$ and $\Sigma_A^C \subseteq \mathbb{N}$. This leads to a reduced memory consumption in subsequent algorithms. Each canonical vertex has one unique label, differing from labels of other canonical vertices, *i.e.*, $|\Sigma_V^C| = |V^C|$. This “relabeling” is inspired by the work of de Vries and de Rooij [13] that use a structure named *pathMap* to represent a path by an integer. We developed our own structure for this relabeling, which we named `CacheManager`.

3.2 Mining interesting neighbors and types

3.2.1 Mining interesting neighbors

Here, we select all vertices that are neighbors of at least one seed vertex in N^C by performing a breadth-first search constrained by parameters k , d , u , $b_{\text{predicates}}$, and $b_{\text{exp-types}}$. Neighbors are selected by traversing at most k arcs from the seed vertices in N^C . If $u = \text{false}$, then only outgoing arcs are traversed; otherwise, all arcs are traversed regardless of their orientation.

However, not all neighboring vertices are of interest. For example, we want to avoid provenance metadata vertices. Indeed, they may not constitute discriminative features as they are specific to the vertex they describe. As we aim to use ontology classes to generate path patterns, we also need to keep the graph exploration over the individuals of \mathcal{K} and avoid traversing `rdf:type` arcs. To this aim, we do not traverse arcs that are labeled by a predicate whose URI or prefix of URI is blacklisted in $b_{\text{predicates}}$. For example, we blacklist in $b_{\text{predicates}}$ the prefix of the provenance ontology `PROV-O`⁵ and the URI of the `rdf:type` predicate⁶.

Additionally, we provide a blacklist $b_{\text{exp-types}}$ of URIs or prefixes of classes whose instances must not be reached. Hence, we do not reach individuals that instantiate directly or indirectly a blacklisted class, by following `rdf:type` and `rdfs:subClassOf` arcs. For example, in a use case of classifying drugs that cause or not a side effect, one may want to avoid neighbors that represent the side effect. That is why, the ontology class representing the side effect is blacklisted in $b_{\text{exp-types}}$.

⁵<http://www.w3.org/ns/prov#>

⁶<http://www.w3.org/1999/02/22-rdf-syntax-ns#type>

When mining neighboring vertices, we may encounter vertices with a high degree, hereafter named *hubs*. If the graph exploration considered their numerous neighbors, then the size of the selected neighborhood would increase exponentially, thus causing a scalability issue. Additionally, hub neighbors may not constitute specific and discriminative features. Indeed, if a hub can be reached from some seed vertices, *i.e.*, appears in their neighborhood, the neighbors of the hub will be reached by the same seed vertices. That is why, in our approach, we propose to stop the graph exploration at vertices whose degree is strictly greater than parameter d^7 .

Remark 2. If $u = \text{false}$, then the degree of a vertex only counts outgoing arcs, otherwise all arcs are counted. The degree does not count arcs whose predicate is blacklisted in $b_{\text{predicates}}$. The degree counts arcs incident to a vertex that instantiates a blacklisted class in $b_{\text{exp-types}}$.

As a result, with $k, d, u, b_{\text{predicates}}$, and $b_{\text{exp-types}}$ fixed, we obtain a set of neighboring vertices, denoted by $\mathcal{N}(N^C) \subseteq V^C$. Each neighboring vertex $v \in \mathcal{N}(N^C)$ may only appear in the neighborhood of some seed vertices from N^C w.r.t. the parameters. Thus, v is associated with these seed vertices, which we indicate by defining the *support set* of v .

Definition 1 (Support set of a neighbor). For a given choice of these parameters, the *support set* of a neighboring vertex $v \in \mathcal{N}(N^C)$ is denoted by $\text{SUPPORTSET}(v) \subseteq N^C$ and defined as the set of seed vertices from N^C having v as neighbor. The support of a neighbor is defined as the cardinal of its support set.

Note that some vertices in $\mathcal{N}(N^C)$ are not very discriminative: when they are associated with very few vertices from N^C or nearly all of them. This motivates the use of parameters l_{\min} and l_{\max} that define the minimum and maximum support for a neighbor to appear in the set \mathcal{F} of features. Hence, a neighbor $v \in \mathcal{N}(N^C)$ constitutes a feature in the output matrix \mathcal{M} if and only if $l_{\min} \leq |\text{SUPPORTSET}(v)| \leq l_{\max}$. We denote the set of interesting neighbors to appear in \mathcal{F} by

$$\mathcal{N}_l(N^C) = \{v \mid v \in \mathcal{N}(N^C) \text{ and } l_{\min} \leq |\text{SUPPORTSET}(v)| \leq l_{\max}\}.$$

In \mathcal{M} , for $n^C \in N^C$ and $v \in \mathcal{N}_l(N^C)$, we have $\mathcal{M}_{n^C, v} = \text{true}$ if and only if $n^C \in \text{SUPPORTSET}(v)$.

Example 1. From \mathcal{K}^C in Figure 1 and with $k = 3, d = 4, l_{\min} = 2, l_{\max} = 3, u = \text{false}, b_{\text{predicates}} = \{\text{type}, \text{subClassOf}\}$, and $b_{\text{exp-types}} = \emptyset$, we obtain:

$$\begin{aligned} \mathcal{N}(N^C) &= \{v_1, v_2, v_3, v_4, v_5, v_6, v_8, v_9\}; \\ \text{SUPPORTSET}(v_1) &= \text{SUPPORTSET}(v_6) = \{n_1^C, n_2^C\}; \\ \text{SUPPORTSET}(v_2) &= \text{SUPPORTSET}(v_3) = \text{SUPPORTSET}(v_8) = \{n_1^C\}; \\ \text{SUPPORTSET}(v_4) &= \text{SUPPORTSET}(v_5) = \text{SUPPORTSET}(v_9) = \{n_2^C\}; \\ \mathcal{N}_l(N^C) &= \{v_1, v_6\}. \end{aligned}$$

The graph exploration stops at v_1 . Indeed, it is considered a hub as its degree is greater than d . Thus, vertices on the left of Figure 1 are not explored. Because $u = \text{false}$, the graph exploration cannot reach v_7 . If $b_{\text{exp-types}} = \{T_3\}$, then v_3 and v_5 cannot be traversed, resulting in $\mathcal{N}(N^C) = \{v_1, v_2, v_4, v_8, v_9\}$.

3.2.2 Mining interesting types

Observe that we can use $\mathcal{N}(N^C)$ to compute interesting types over the considered neighborhood. These interesting types will alleviate a scalability issue arising when building path patterns in Subsection 3.3. Interesting types must be computed over $\mathcal{N}(N^C)$ and not $\mathcal{N}_l(N^C)$ as vertices whose support is below l_{\min} can instantiate interesting types. As an intuitive example, in Figure 1, T_3 is associated with both n_1^C (because of v_3) and n_2^C (because of v_5). For $l_{\min} = 2$, v_3 and v_5 will not be selected as features, however T_3 can be used in path patterns.

Parameters t and $b_{\text{gen-types}}$ constrain the ontology classes considered in the construction of path patterns, and thus they are integrated in the computation of interesting types. Parameter t specifies the maximum level of considered classes in ontology hierarchies. This level is computed by starting at vertices to generalize and following `rdf:type` and `rdfs:subClassOf` arcs. $t = 0$ only allows to generalize vertices with \top , which is considered to be instantiated by all vertices. For example, v_3 can be generalized by T_2 and \top if $t = 1$, and by T_2, T_3 , and \top if $t = 2$. Additionally, types used for generalization must not be blacklisted in $b_{\text{gen-types}}$. This blacklist consists of URIs or prefixes of ontology classes not to be used during the construction of path patterns. For example, we refrain from considering general classes such as `pgxo:Drug`⁸.

⁷From a similar assessment, de Vries and de Rooij [14] tackle the hub issue by removing edges based on frequency of pairs (source, predicate) and (predicate, target).

⁸<http://pgxo.loria.fr/Drug>

To compute interesting types, we must first compute their support set. This motivates the following predicate:

$$\text{inst}(v, T, t, b_{\text{gen-types}}) = \begin{cases} \text{true} & \text{if } v \text{ instantiates } T \text{ under parameters } t \text{ and } b_{\text{gen-types}} \\ \text{false} & \text{otherwise} \end{cases}$$

We can then define the support set of an ontology class T as follows:

Definition 2 (Support set of an ontology class). The support set of an ontology class T is the union of support sets of vertices $v \in \mathcal{N}(N^C)$ that can be generalized by T under parameters t and $b_{\text{gen-types}}$. Formally:

$$\text{SUPPORTSET}(T) = \bigcup_{\substack{v \in \mathcal{N}(N^C) \\ \text{inst}(v, T, t, b_{\text{gen-types}})}} \text{SUPPORTSET}(v)$$

Finally, the set of interesting types used to build path patterns is defined as $\mathcal{T}_{\geq l_{\min}} = \{T \mid l_{\min} \leq |\text{SUPPORTSET}(T)|\}$.

Example 2. With the same parameters as in Example 1, we obtain

$$\text{SUPPORTSET}(T_2) = \{n_1^C\}; \quad \text{SUPPORTSET}(T_1) = \{n_1^C, n_2^C\}; \quad \mathcal{T}_{\geq l_{\min}} = \{T_1, T_3, T_5, T_6, \top\}.$$

3.3 Mining interesting paths and path patterns

This step focuses on mining interesting paths and path patterns rooted by seed vertices $n^C \in N^C$. We use the term *path feature* (PF) to indicate a path or a path pattern.

Definition 3 (Path feature). A path feature is a sequence of atomic elements that are pairs $\overset{p}{\rightarrow} E$ where p is a predicate and E is either (i) an individual (for paths), or (ii) an individual or an ontology class (for path patterns). The length of a path feature counts the number of its atomic elements.

Example 3. In Figure 1, the path $\overset{p_1}{\rightarrow} v_2 \overset{p_2}{\rightarrow} v_3 \overset{p_3}{\rightarrow} v_6$ can be rooted by n_1^C and is of length 3. The path pattern $\overset{p_1}{\rightarrow} T_1 \overset{p_2}{\rightarrow} T_3$ can be rooted by n_1^C and n_2^C and is of length 2.

Interesting path features are built by a breadth-first expansion starting at vertices in N^C . As previously, k defines the maximum number of arcs traversed. Hence, path features are of length 1 to k . Observe that a scalability issue arises when mining interesting path features. Indeed, there may be several paths between two vertices and each vertex in a path can be generalized by several ontology classes. For instance, for $t = 2$, $\overset{p_1}{\rightarrow} v_2 \overset{p_2}{\rightarrow} v_3 \overset{p_3}{\rightarrow} v_6$ can be generalized by up to 23 path patterns. We propose a mining procedure that alleviates the scalability issues associated with the mining of path patterns. This mining procedure relies on the *monotonicity* of the support set of path features, which is defined as follows:

Definition 4 (Support set of a path feature). The support set of a path consists of all vertices from N^C that root it in \mathcal{K}^C . Formally,

$$\text{SUPPORTSET}(\overset{p_a}{\rightarrow} v_a \dots \overset{p_b}{\rightarrow} v_b) = \left\{ n^C \in N^C \mid n^C \overset{p_a}{\rightarrow} v_a \dots \overset{p_b}{\rightarrow} v_b \text{ exists in } \mathcal{K}^C \right\}.$$

The support set of a path pattern consists of all vertices from N^C that root a path in \mathcal{K}^C that is captured by the path pattern. Formally,

$$\text{SUPPORTSET}(\overset{p_a}{\rightarrow} E_a \dots \overset{p_b}{\rightarrow} E_b) = \left\{ n^C \in N^C \mid n^C \overset{p_a}{\rightarrow} v_a \dots \overset{p_b}{\rightarrow} v_b \text{ exists in } \mathcal{K}^C \text{ and } \forall v_i, v_i = E_i \text{ or } \text{inst}(v_i, E_i, t, b_{\text{gen-types}}) \right\}.$$

The support of a path feature is defined as the cardinal of its support set.

Example 4. From Figure 1, we have $\text{SUPPORTSET}(\overset{p_1}{\rightarrow} v_2 \overset{p_2}{\rightarrow} v_3 \overset{p_3}{\rightarrow} v_6) = \{n_1^C\}$.

Our approach of mining interesting path features is guided by the *dependency structure* as illustrated in Figure 3. At first, this structure is empty and it is then augmented at each iteration of Algorithm 1, whose operations are described and illustrated below.

Remark 3. As introduced in Remark 1, there are some hacks to help mitigating some of the scalability drawbacks. Storing and manipulating a path feature as a list of elements has a high memory footprint. Thus, such a list is only stored once in our `CacheManager` structure and the returned index (from \mathbb{N}) is used in mining algorithms.

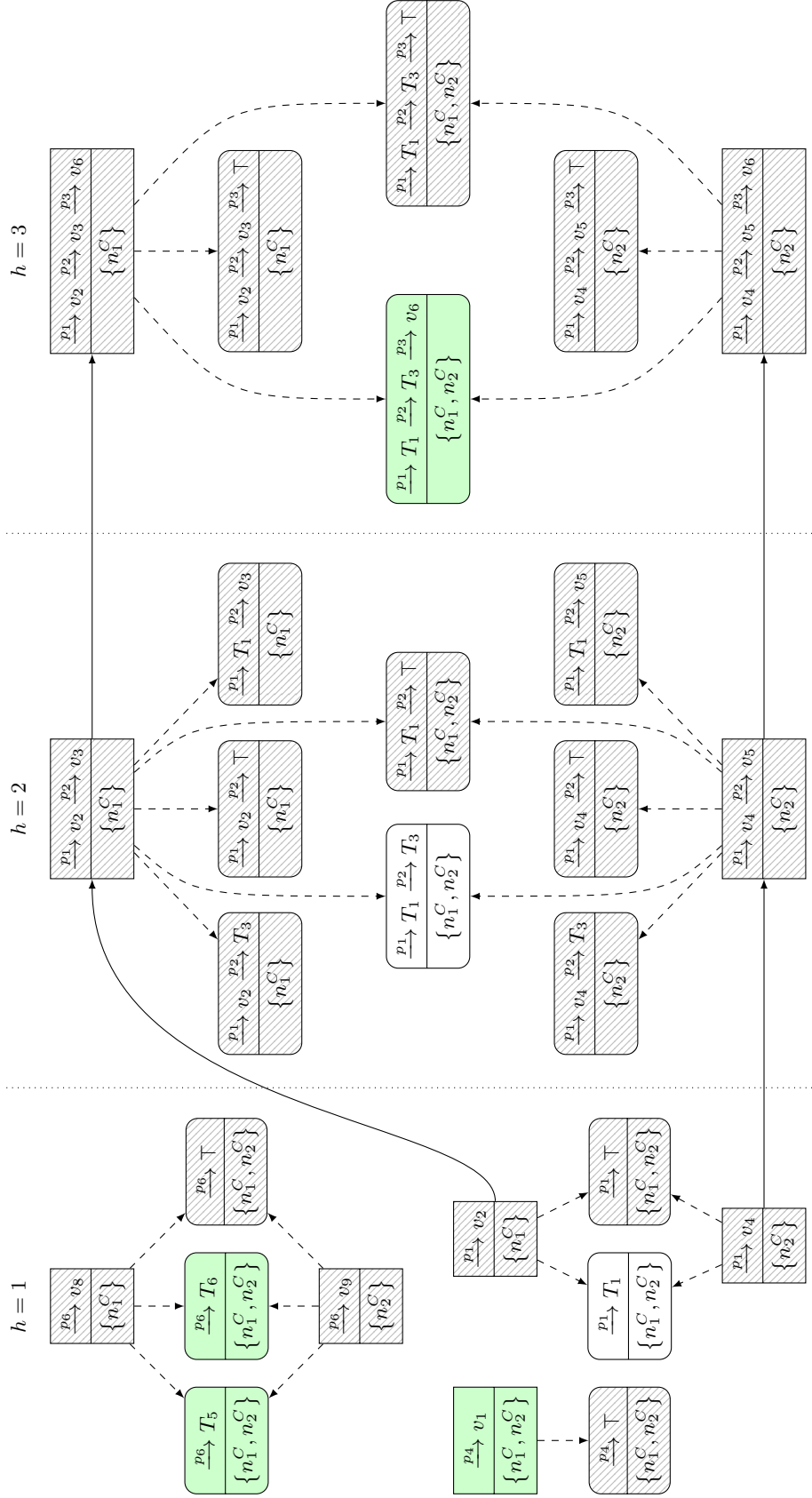

Figure 3: Dependency structure used when mining interesting path features from the canonical graph in Figure 1. Parameters are $k = 3$, $t = 2$, $d = 4$, $u = \text{false}$, $b_{\text{predicates}} = \{\text{type}, \text{subclassOf}\}$, $b_{\text{exp-types}} = \emptyset$, $b_{\text{gen-types}} = \emptyset$, $l_{\text{min}} = 2$, and $l_{\text{max}} = 3$. Path features are displayed with their support set. Solid arrows represent expansion, dashed arrows represent generalization, rectangles represent paths, and rounded rectangles represent path features with identical support set. Green rectangles represent path features ultimately added to \mathcal{F} . Blank rectangles represent path features that respect specificity and support constraints but are not in \mathcal{F} because of other features (in green). For readability purposes, path features are displayed as the list of their elements instead of indices from \mathbb{N} actually used to save memory.

Algorithm 1 Mining interesting paths and path patterns

Input: The canonical knowledge graph \mathcal{K}^C , the set of canonical seed vertices N^C , the set of interesting types $\mathcal{T}_{\geq l_{\min}}$

Parameters: $k, t, d, l_{\min}, l_{\max}, u, b_{\text{predicates}}, b_{\text{exp-types}}, b_{\text{gen-types}}$

Output: \mathcal{F} and \mathcal{M} completed with interesting paths and path patterns

- 1: $h \leftarrow 1$
 - 2: **repeat**
 - 3: Expand paths in \mathcal{P}_h
 - 4: Generalize expanded paths into path patterns
 - 5: Keep most specific path features
 - 6: Select (i) generated path features to add to \mathcal{F} (complete \mathcal{M} accordingly), and (ii) paths to add to \mathcal{P}_{h+1}
 - 7: $h \leftarrow h + 1$
 - 8: **until** $h > k$ or $\mathcal{P}_h = \emptyset$
-

3.3.1 Expand paths in \mathcal{P}_h

Each path $P \in \mathcal{P}_h$ ⁹ is expanded with pairs $\xrightarrow{P_e} v_e$ that are chosen in the neighborhood of the last individual of P . This choice is constrained by parameters $k, d, u, b_{\text{predicates}}$, and $b_{\text{exp-types}}$ as in Subsection 3.2¹⁰. In the first iteration, the neighborhood of seed vertices in N^C is used. If no path in \mathcal{P}_h can be expanded, *i.e.*, the neighborhood of their last vertex does not contain reachable vertices under the constraints, then Algorithm 1 ends.

Example 5. From the graph in Figure 1, the first expansion generates the following paths: $\xrightarrow{P_4} v_1, \xrightarrow{P_1} v_2, \xrightarrow{P_1} v_4, \xrightarrow{P_6} v_8$, and $\xrightarrow{P_6} v_9$. In the second expansion, $\xrightarrow{P_4} v_1$ is not expanded as v_1 is a hub under $d = 4$. Since their respective neighborhood does not contain reachable vertices, $\xrightarrow{P_6} v_8$ and $\xrightarrow{P_6} v_9$ are also not expanded. The expansion of $\xrightarrow{P_1} v_2$ generates $\xrightarrow{P_1} v_2 \xrightarrow{P_2} v_3$ whereas the expansion of $\xrightarrow{P_1} v_4$ generates $\xrightarrow{P_1} v_4 \xrightarrow{P_2} v_5$.

3.3.2 Generalize expanded paths into path patterns

Let P_e be the expansion of $P \in \mathcal{P}_h$ as previously described, *i.e.*, $P_e = P \xrightarrow{P_e} v_e$. We generalize P_e by:

- Generating patterns $P \xrightarrow{P_e} T$ with types $T \in \mathcal{T}_{\geq l_{\min}}$ for which the predicate $\text{inst}(v_e, T, t, b_{\text{gen-types}})$ is verified.
- Retrieving from the dependency structure the path patterns that generalize P^{11} and expanding them with $\xrightarrow{P_e} v_e$, and $\xrightarrow{P_e} T$ for all $T \in \mathcal{T}_{\geq l_{\min}}$ for which the predicate $\text{inst}(v_e, T, t, b_{\text{gen-types}})$ is verified.

Intuitively, this generalization operation allows to expand path patterns.

Example 6. In the first iteration, $\xrightarrow{P_1} v_2$ is generalized by $\xrightarrow{P_1} T_1$ and $\xrightarrow{P_1} \top$. As we will see, $\xrightarrow{P_1} \top$ is not kept in the dependency structure at the end of the first iteration (see Subsections 3.3.3 and 3.3.4). In the second iteration, $\xrightarrow{P_1} v_2$ expands into $\xrightarrow{P_1} v_2 \xrightarrow{P_2} v_3$. In the dependency structure, we retrieve $\xrightarrow{P_1} T_1$ as the path pattern generalizing $\xrightarrow{P_1} v_2$, which is expanded into $\xrightarrow{P_1} T_1 \xrightarrow{P_2} v_3, \xrightarrow{P_1} T_1 \xrightarrow{P_2} T_3$, and $\xrightarrow{P_1} T_1 \xrightarrow{P_2} \top$.

We only generalize paths with types $T \in \mathcal{T}_{\geq l_{\min}}$ to avoid the generation an important number of uninteresting path patterns that would then be discarded, thus reducing the memory footprint. Indeed, by definition, if $T \notin \mathcal{T}_{\geq l_{\min}}$, then $|\text{SUPPORTSET}(T)| < l_{\min}$. Additionally, given a path feature P , $|\text{SUPPORTSET}(P)| \leq \min_{E \in P} |\text{SUPPORTSET}(E)|$, where E can be a class or an individual involved in P . Thus, if $T \notin \mathcal{T}_{\geq l_{\min}}$ is used in a path pattern P , we would have $|\text{SUPPORTSET}(P)| < l_{\min}$, therefore generating an uninteresting path pattern that would be discarded later.

3.3.3 Keep most specific path features

Inspired by works that prune redundant generalized rules during their generation [21], we keep only the “most specific” path patterns among those that have the same support set.

⁹ \mathcal{P}_h is explained in Subsection 3.3.4.

¹⁰Additionally, to avoid loops, P can only be expanded at iteration h with individuals v_e such that there exists at least one seed vertex in $\text{SUPPORTSET}(P)$ whose shortest distance to v_e is h .

¹¹Not all generated path patterns remain in the dependency structure at the end of an iteration, see Subsections 3.3.3 and 3.3.4.

Definition 5 (More specific path pattern). A path pattern P_1 is *more specific* than another path pattern P_2 if every atomic element of P_1 is more specific than the atomic element of P_2 at the same position. An atomic element $\xrightarrow{p_1} E_1$ is more specific than another atomic element $\xrightarrow{p_2} E_2$ if and only if:

- (i) $p_1 = p_2$, *i.e.*, both atomic elements involve the same predicate¹², and
- (ii) E_1 is more specific than E_2 ¹³.

When path patterns have the same support set, keeping the most specific ones remove redundant generalizations, thus reducing their number and the computational burden. Additionally, we ensure a high descriptive power because the most specific paths are the most descriptive. Intuitively, a path pattern involving a class T is less descriptive than another pattern involving a subclass or an instance of the class. However, keeping the most specific path patterns is computationally expensive, which led us to propose the following computational procedure.

We notice that the support set of a path pattern is the union of the support sets of the paths it generalizes. Therefore, we discard path patterns that generalize only one path. Indeed, such path patterns have the same support set as their original path and are more general, by definition.

Example 7. For $h = 3$, we discard the following path patterns: $\xrightarrow{p_1} v_2 \xrightarrow{p_2} v_3 \xrightarrow{p_3} \top$ and $\xrightarrow{p_1} v_4 \xrightarrow{p_2} v_5 \xrightarrow{p_3} \top$.

However, there may exist path patterns that generalize several more specific path features while having the same support set. Such path patterns should also be discarded.

Example 8. For $h = 1$, $\xrightarrow{p_1} \top$ shares the same support set as the more specific path pattern $\xrightarrow{p_1} T_1$ and thus should be discarded.

To efficiently discard path patterns, we avoid computing their whole hierarchy. Instead, we focus on retaining only the most specific ones in the *prefix tree* depicted in Figure 4. This prefix tree is incrementally augmented and stores the most specific path patterns for a specific iteration and support set. In this tree, individuals/classes and predicates involved in path patterns are indexed separately. Thus, its depth is twice the length of path patterns of the current iteration.

The prefix tree enables an efficient storage and selection of the most specific path patterns. Indeed, let P be a path pattern to be compared with those already stored. A breadth-first traversal is performed to detect more specific patterns than P : we only traverse identical or more specific elements according to Definition 5. At any depth, if such elements cannot be found, then P is one of the most specific patterns and the traversal stops. On the contrary, if the traversal reaches a leaf containing more specific elements, then there is a pattern more specific than P with the same support set. Consequently, P is discarded and removed from the dependency structure.

If P is to be stored, another breadth-first traversal is performed by considering identical or more general elements than the ones in P . When the traversal reaches a leaf, it means that more general patterns than P are currently stored and have the same support set. These are removed from the prefix tree before storing P . They are also removed from the dependency structure.

Remark 4. As the prefix tree relies on associative arrays and sets, the computational cost of traversal, insertion, and removal is reduced. Additionally, resetting the tree at each expansion and each support set reduces the number of patterns to traverse and thus the global computational cost.

3.3.4 Select generated path features to add to \mathcal{F} , and paths to add to \mathcal{P}_{h+1}

In this subsection, we determine (i) which paths and path patterns should be added as features in \mathcal{F} , and consequently, (ii) which paths to add to \mathcal{P}_{h+1} , *i.e.*, to expand during the next iteration.

A path feature P can be added in \mathcal{F} if:

- (C1) $l_{\min} \leq \text{SUPPORTSET}(P) \leq l_{\max}$,
- (C2) Prefixes of P with the same support set do not already exist in \mathcal{F} ,
- (C3) If P is a path pattern, it does not generalize a path with the same support set.

When P is in \mathcal{F} , the output binary matrix \mathcal{M} verifies $\mathcal{M}_{n^C, P} = \text{true}$ for all $n^C \in \text{SUPPORTSET}(P)$.

¹²It is noteworthy that we do not consider the hierarchy of predicates in this work.

¹³A class is more specific than all its super-classes and an individual is more specific than all classes it instantiates.

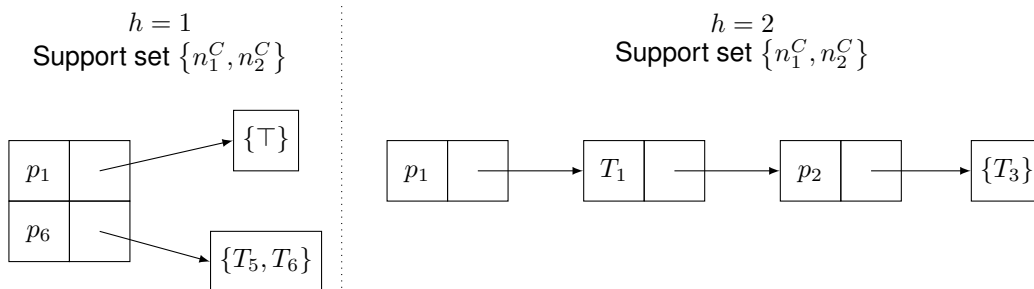

Figure 4: Prefix tree used when computing most specific path patterns during the first and second iterations considering the support set $\{n_1^C, n_2^C\}$. This structure is reset at each expansion and for each support set. For $h = 1$, when considering $\xrightarrow{p_1} T_1$, the structure will evolve: $\xrightarrow{p_1} T$ will be removed and replaced by the considered path. For $h = 3$, when considered, $\xrightarrow{p_1} T_1 \xrightarrow{p_2} T$ will be discarded as more general than $\xrightarrow{p_1} T_1 \xrightarrow{p_2} T_3$.

Remark 5. Note that (C2) allows to focus on shorter paths in \mathcal{F} . However, (C2) is not applied if P ends with an individual and there exist a prefix of P in \mathcal{F} that ends with a class. P is considered more descriptive than its prefix, because of the individual in the last position. Hence, we add P in \mathcal{F} and remove its prefix. For example, in Figure 3, $\xrightarrow{p_1} T_1 \xrightarrow{p_2} T_3$ is replaced by $\xrightarrow{p_1} T_1 \xrightarrow{p_2} T_3 \xrightarrow{p_3} v_6$ in \mathcal{F} for $h = 3$.

Remark 6. (C3) is motivated as the path is more specific and thus more descriptive than P and should be added instead of P .

We also select the paths and path patterns to expand during the next iteration. To reduce their number, we rely on the l_{\min} constraint and the *monotonicity* of the support set. It is clear that, for a path feature P , we have $|\text{SUPPORTSET}(P)| \leq \min_{E \in \mathcal{P}} |\text{SUPPORTSET}(E)|$, where E can be a class or an individual involved in P . Thus, when expanding a path feature, its support set remains identical (for paths and path patterns) or decreases (for path patterns).

Consequently, we add to \mathcal{P}_{h+1} paths whose expansion may generate path features complying with the l_{\min} constraint, *i.e.*, paths with a support greater than l_{\min} or paths that are generalized by a pattern with a support greater than l_{\min} . This monotonicity property also lets us remove from the dependency structure patterns whose support is lower than l_{\min} . Indeed, such patterns cannot be used during the generalization step of the next iteration since they will inevitably generate a pattern whose support is smaller than l_{\min} . As a result, the monotonicity property does entail a reduction in the number of paths and path patterns considered in the next iteration, thus reducing the computational cost.

Example 9. For example, in the first iteration, the path $\xrightarrow{p_1} v_2$ is added to \mathcal{P}_2 as it is generalized by $\xrightarrow{p_1} T_1$ whose support is greater than $l_{\min} = 2$. At the end of the second iteration, we remove $\xrightarrow{p_1} v_2 \xrightarrow{p_2} T_3$ because its support is lower than $l_{\min} = 2$, and thus its expansion cannot generate an interesting pattern.

3.4 Optional and domain-dependent filtering

After the previous steps, we obtain a feature set \mathcal{F} containing interesting neighbors, paths, and path patterns. These features have been mined without taking into account domain constraints known to experts. We propose to apply domain-dependent filtering on \mathcal{F} with parameter m . Such filters reduce the size of \mathcal{F} and integrate interestingness constraints based on expert knowledge.

Example 10. To classify drugs causing or not a side effect, experts may want to focus on features containing a biological pathway, a gene or a GO class, or a MeSH class. Therefore, we propose three atomic filters, only keeping neighbors, paths, and path patterns containing at least a pathway ($m = p$), a gene or a GO class ($m = g$), or a MeSH class ($m = m$). Such atomic filters can be combined to form disjunctive filters. For example, the $m = pg$ filter keeps features from \mathcal{F} containing at least a pathway *or* a gene or a GO class. When a filter is applied to a neighbor, this neighbor must be, *e.g.*, a pathway for the p filter. When a filter is applied to a path or a path pattern, it means that one of its individuals / ontology classes must be, *e.g.*, a pathway for the p filter.

This domain-dependent filtering is similar to approaches that generalize association rules and prune those that involve some specified ontology classes [21, 22].

4 Experimental setup

To illustrate our approach, we will address the following task: from a knowledge graph, mine a set of features to classify drugs depending on whether they cause a specific side effect.

We explore PGxLOD¹⁴ [10], a knowledge graph that aggregates several sets of Linked Open Data (LOD) describing drugs, phenotypes, and genetic factors: PharmGKB, ClinVar, DrugBank, SIDER, DisGeNET, and CTD. This aggregation may lead to features combining units from several LOD sets. Indeed, LOD sets may contain different and incomplete knowledge. Their combined use then enables leveraging a greater amount of knowledge, where some LOD sets complete information provided by others. This asks for a canonical knowledge graph as described in Subsection 3.1. For instance, it is possible to complete the knowledge related to a drug described in PharmGKB if it is linked with an `owl:sameAs` arc to the same drug described in DrugBank. This constitutes the key interest in combining LOD sets in knowledge discovery and data mining tasks, as discussed by Ristoski and Paulheim [23].

We will use the following data sets that comprise positive (\oplus) and negative (\ominus) drug examples:

Data set 1 (Drug Induced Liver Injury (DILI) [24]). It is formed by 1,036 drugs in 4 classes: “most DILI concern” (192 drugs), “ambiguous DILI concern” (254 drugs), “less DILI concern” (278 drugs), and “no DILI concern” (312 drugs). We mapped these drugs from their PubChem identifiers to identifiers from PharmGKB, otherwise DrugBank, otherwise KEGG, resulting in the set of seed vertices $N^{\text{DILI}} = N_{\oplus}^{\text{DILI}} \cup N_{\ominus}^{\text{DILI}}$ such that:

- $|N_{\oplus}^{\text{DILI}}| = 146$ drugs (118 from PharmGKB, 17 from DrugBank, and 11 from KEGG). The positive drug examples are from the “most DILI concern” class.
- $|N_{\ominus}^{\text{DILI}}| = 224$ drugs (206 from PharmGKB, 9 from DrugBank, and 9 from KEGG). The negative drug examples are from the “no DILI concern” class.

Data set 2 (Severe Cutaneous Adverse Reactions (SCAR)¹⁵). It is formed by 874 drugs in 5 classes: “very probable” (18 drugs), “probable” (19 drugs), “possible” (94 drugs), “unlikely” (697 drugs), and “very unlikely” (46 drugs). We mapped these drugs from their PubChem identifiers to identifiers from PharmGKB, otherwise DrugBank, otherwise KEGG, resulting in the set of seed vertices $N^{\text{SCAR}} = N_{\oplus}^{\text{SCAR}} \cup N_{\ominus}^{\text{SCAR}}$ such that:

- $|N_{\oplus}^{\text{SCAR}}| = 102$ drugs (100 from PharmGKB and 2 from DrugBank). The positive drug examples are from the “very probable”, “probable”, and “possible” classes.
- $|N_{\ominus}^{\text{SCAR}}| = 290$ drugs (286 from PharmGKB and 4 from DrugBank). The negative drug examples are from the “unlikely” and “very unlikely” classes.

We implemented our approach in Python¹⁶. We used a server with 700 GB of RAM and the following parameter values $k \in \{1, 2, 3, 4\}$, $t \in \{1, 2, 3\}$, $d = 500$, $u = \text{false}$, $l_{\min} = 5$, $l_{\max} = +\infty$, and $m \in \{\text{p, g, m, pg, pgm}\}$. It should be noted that $k = 4$ was only tested with $t = 1$ because of memory issues caused by the high number of generated features.

Statistics about the features are detailed for $k = 3$, $t = 3$ and $k = 4$, $t = 1$ in Table 2 and discussed in the next section. We obtained the features associated with the DILI data set under $k = 3$, $t = 3$ in approximately 1 hour. However, computing the features with $k = 4$, $t = 1$ on the same data set required 4 days and 380 GB of RAM.

5 Results and discussion

The first two lines of Table 2 show the number of neighbors and types reachable before applying support limits. Enforcing these limits constitutes a first reduction of these numbers, thus reducing the memory and computational footprints. Here, numbers are approximately divided by 2. The mining of path features always relies on l_{\min} , and thus it is not possible to count the number of all possible paths and path patterns. However, we show the number of path features generated during the mining, which already illustrates the combinatorial explosion. Enforcing support constraints and removing redundant generalizations allow to reduce their number in \mathcal{F} (here, approximately by 20). Finally, the domain-dependent filtering defined by m also radically scales down the number of features ultimately output. However, this filtering only happens as post-processing and does not alleviate the scalability issues arising during the mining of patterns.

We observe a drastic increase in the number of neighbors and path features alongside k , which highlights the scalability issues of mining large knowledge graphs. Considering additional levels in ontology hierarchies by increasing t also

¹⁴<https://pgxlod.loria.fr>

¹⁵<http://www.regiscar.org/>

¹⁶<https://github.com/pmonnin/kgpm>

Table 2: Number of features mined for the two considered data sets for parameters $d = 500$, $u = \text{false}$ before and after applying $l_{\min} = 5$, $l_{\max} = +\infty$, and $m = \text{pgm}$. Path features are always computed considering at least l_{\min} to avoid combinatorial explosion. We display the number of path features generated (gen.) during the exploration and the number of path features ultimately in \mathcal{F} after keeping the most specific and applying limit constraints. Types are not considered as features but are displayed to illustrate the possible combinatorial explosion in path patterns. Statistics about the full neighborhood are given as comparison.

		DILI		SCAR	
		$k = 3, t = 3$	$k = 4, t = 1$	$k = 3, t = 3$	$k = 4, t = 1$
Before l_{\min} and l_{\max}	Neighbors	175,652	628,681	179,694	639,050
	Types	13,580	18,940	13,677	18,526
After l_{\min} and l_{\max}	Neighbors	71,560	281,657	90,690	312,029
	Types	7,372	12,421	8,800	13,177
	Path features in \mathcal{F}	790,605	10,169,975	1,146,585	10,729,002
	Path features gen.	20,145,635	251,791,519	29,011,996	255,672,772
After m	Neighbors	4,069	31,804	4,214	33,361
	Path features in \mathcal{F}	102,674	2,291,846	147,936	2,400,642
Full neighborhood ($d = 500$)	Neighbors	2,419,957		2,419,920	
	Types	51,477		51,472	
	Reached at k, t	$k = 23, t = 21$		$k = 23, t = 21$	
Full neighborhood ($d = +\infty$)	Neighbors	5,488,531		5,488,510	
	Types	53,486		53,484	
	Reached at k, t	$k = 19, t = 21$		$k = 20, t = 21$	

multiplies the number of path features. To illustrate, with 700 GB of RAM, we could not set t to values greater than 1 for $k = 4$. Consequently, there is still room for improvements in terms of memory consumption, *e.g.*, through an efficient storing of paths and path patterns. These future improvements could enable to consider the full neighborhood of seed vertices, which is reached for greater values of k and t and involves a far greater amount of vertices. For example, for the DILI data set, the full neighborhood is reached for $k = 23$ and $t = 21$ (for $d = 500$), or $k = 19$ and $t = 21$ (when the degree constraint is disabled). The full amount of reachable neighbors is 4 times ($d = 500$) or 9 times greater ($d = +\infty$) than with $k = 4$.

The values of parameters depend on the objectives and domain knowledge of the analyst guiding the mining process, especially for blacklists and support thresholds. However, metrics about the knowledge graph may provide guidance. Indeed, statistics about node degrees can help to find a trade-off between exploration and combinatorial explosion with parameter d . Similarly, the depth of class hierarchies influences the value of t . For example, general classes may not be of interest to the analyst, thus reducing t . The parameter k can be set by considering the graph diameter. As it is common in mining processes, iterations may be required to find the best configuration. Regarding m , it is for now hard-coded and only suitable to some biomedical applications. Inspired by ontologies that allow to interactively define mining workflows [3], we could adapt this parameter to other applications by proposing such an interactive definition.

When manually reviewing the output features, we noticed multiple path features across the aggregated LOD sets. This is made possible by aggregating and canonicalizing multiple LOD sets in the knowledge graph. This result particularly illustrates one of the fundamental aspects of Linked Open Data: the combination of different data sets enables to go beyond their original purposes and coverage. However, it is clear that combining LOD sets leads to bigger knowledge graphs, exacerbating the scalability issues.

Regarding our approach, we only canonicalize vertices, *i.e.*, individuals and ontology classes. Nevertheless, predicates used on arcs can also be identified as identical, leading to a canonicalization of arcs. In this context, we could benefit from matching approaches, such as PARIS [25]. By identifying identical classes, predicates, and individuals, these matching approaches could further improve the canonicalization and, therefore, increase the number of common features between seed vertices from different data sets. Similarly, we could consider literals and arcs incident to literals that were purposely discarded here. However, the canonicalization of literals raises several challenging issues due to their heterogeneity in terms of syntactic variations, unit measures, and the precision of numerical values. Other reasoning mechanisms and semantics associated with Semantic Web standards could be taken into account. For example, predicates can be defined as transitive, and thus the canonical knowledge graph could also result from their transitive closure.

Regarding the modeling of path patterns, we could generalize paths with both the hierarchy of classes and the hierarchy of predicates. In addition to keeping the most specific patterns, we could use other metrics to further reduce their redundancy (*e.g.*, approaches relying on hierarchies [26, 27] and extents of ontological classes [27]). This could also reduce the number of generated patterns, therefore improving the scalability of the mining approach. Neighbors could be enriched with the distance between them and seed vertices, which would correspond to the generalized paths of KGPTree [18]. We could also use other approaches than binary features (*e.g.*, counting [13, 14], relative counting [28]). More importantly, it remains to test our mined features within a complete classification task to measure the influence of k , t , and the three kinds of features (neighbors, paths, and path patterns).

6 Conclusion

In this preliminary study, we addressed the scalability issues associated with the task of mining neighbors, paths, and path patterns from a knowledge graph and a set of seed vertices. We proposed a method for tackling these issues, which we illustrated by mining a real-world knowledge graph. Our results highlight the importance of considering the scalability of approaches when mining features from ever-growing knowledge graphs. Our work alleviates part of the computational cost (time and memory) of mining paths and path patterns but also reveals the need for a further reduction. Such future research works could enable the modeling of more complex path patterns, for example, considering the hierarchy of predicates.

References

- [1] Aidan Hogan, Eva Blomqvist, Michael Cochez, Claudia d’Amato, Gerard de Melo, Claudio Gutierrez, José Emilio Labra Gayo, Sabrina Kirrane, Sebastian Neumaier, Axel Polleres, Roberto Navigli, Axel-Cyrille Ngonga Ngomo, Sabbir M. Rashid, Anisa Rula, Lukas Schmelzeisen, Juan F. Sequeda, Steffen Staab, and Antoine Zimmermann. Knowledge graphs. *CoRR*, abs/2003.02320, 2020.
- [2] Christian Bizer, Tom Heath, and Tim Berners-Lee. Linked data - the story so far. *Int. J. Semantic Web Inf. Syst.*, 5(3):1–22, 2009.
- [3] Petar Ristoski and Heiko Paulheim. Semantic web in data mining and knowledge discovery: A comprehensive survey. *J. Web Semant.*, 36:1–22, 2016.
- [4] Luis Galárraga, Jeremy Heitz, Kevin Murphy, and Fabian M. Suchanek. Canonicalizing open knowledge bases. In Jianzhong Li, Xiaoyang Sean Wang, Minos N. Garofalakis, Ian Soboroff, Torsten Suel, and Min Wang, editors, *Proceedings of the 23rd ACM International Conference on Conference on Information and Knowledge Management, CIKM 2014, Shanghai, China, November 3-7, 2014*, pages 1679–1688. ACM, 2014.
- [5] Heiko Paulheim. Generating possible interpretations for statistics from linked open data. In Elena Simperl, Philipp Cimiano, Axel Polleres, Óscar Corcho, and Valentina Presutti, editors, *The Semantic Web: Research and Applications - 9th Extended Semantic Web Conference, ESWC 2012, Heraklion, Crete, Greece, May 27-31, 2012. Proceedings*, volume 7295 of *Lecture Notes in Computer Science*, pages 560–574. Springer, 2012.
- [6] Baoxu Shi and Tim Weninger. Discriminative predicate path mining for fact checking in knowledge graphs. *Knowl.-Based Syst.*, 104:123–133, 2016.
- [7] Tim Berners-Lee, James Hendler, Ora Lassila, et al. The Semantic Web. *Scientific American*, 284(5):28–37, 2001.
- [8] Thomas R Gruber. A translation approach to portable ontology specifications. *Knowledge Acquisition*, 5(2):199–220, 1993.
- [9] Charu C. Aggarwal and Haixun Wang, editors. *Managing and Mining Graph Data*, volume 40 of *Advances in Database Systems*. Springer, 2010.
- [10] Pierre Monnin, Joël Legrand, Graziella Husson, Patrice Ringot, Andon Tchechmedjiev, Clément Jonquet, Amedeo Napoli, and Adrien Coulet. PGxO and PGxLOD: a reconciliation of pharmacogenomic knowledge of various provenances, enabling further comparison. *BMC Bioinformatics*, 20-S(4):139:1–139:16, 2019.
- [11] Guillaume Bonfante, Bruno Guillaume, and Guy Perrier. *Application of Graph Rewriting to Natural Language Processing*. Wiley Online Library, 2018.
- [12] Pablo Barceló, Leonid Libkin, and Juan L. Reutter. Querying graph patterns. In Maurizio Lenzerini and Thomas Schwentick, editors, *Proceedings of the 30th ACM SIGMOD-SIGACT-SIGART Symposium on Principles of Database Systems, PODS 2011, June 12-16, 2011, Athens, Greece*, pages 199–210. ACM, 2011.

- [13] Gerben Klaas Dirk de Vries and Steven de Rooij. A fast and simple graph kernel for RDF. In Claudia d’Amato, Petr Berka, Vojtech Svátek, and Krzysztof Wecel, editors, *Proceedings of the International Workshop on Data Mining on Linked Data, with Linked Data Mining Challenge collocated with the European Conference on Machine Learning and Principles and Practice of Knowledge Discovery in Databases (ECMLPKDD 2013), Prague, Czech Republic, September 23, 2013.*, volume 1082 of *CEUR Workshop Proceedings*. CEUR-WS.org, 2013.
- [14] Gerben Klaas Dirk de Vries and Steven de Rooij. Substructure counting graph kernels for machine learning from RDF data. *J. Web Semant.*, 35:71–84, 2015.
- [15] Luis Antonio Galárraga, Christina Teffioudi, Katja Hose, and Fabian M. Suchanek. AMIE: association rule mining under incomplete evidence in ontological knowledge bases. In Daniel Schwabe, Virgílio A. F. Almeida, Hartmut Glaser, Ricardo A. Baeza-Yates, and Sue B. Moon, editors, *22nd International World Wide Web Conference, WWW ’13, Rio de Janeiro, Brazil, May 13-17, 2013*, pages 413–422. International World Wide Web Conferences Steering Committee / ACM, 2013.
- [16] Josua Stadelmaier and Sebastian Padó. Modeling paths for explainable knowledge base completion. In *Proceedings of the 2019 ACL Workshop BlackboxNLP: Analyzing and Interpreting Neural Networks for NLP*, pages 147–157, 2019.
- [17] Heiko Paulheim and Johannes Fürnkranz. Unsupervised generation of data mining features from linked open data. In Dumitru Dan Burdescu, Rajendra Akerkar, and Costin Badica, editors, *2nd International Conference on Web Intelligence, Mining and Semantics, WIMS ’12, Craiova, Romania, June 6-8, 2012*, pages 31:1–31:12. ACM, 2012.
- [18] Gilles Vandewiele, Bram Steenwinckel, Femke Ongenaë, and Filip De Turck. Inducing a decision tree with discriminative paths to classify entities in a knowledge graph. In Zhe He, Jiang Bian, Cui Tao, and Rui Zhang, editors, *Proceedings of the 4th International Workshop on Semantics-Powered Data Mining and Analytics co-located with the 18th International Semantic Web Conference (ISWC 2019), Auckland, New Zealand, October 27, 2019.*, volume 2427 of *CEUR Workshop Proceedings*. CEUR-WS.org, 2019.
- [19] Ramakrishnan Srikant and Rakesh Agrawal. Mining generalized association rules. In Umeshwar Dayal, Peter M. D. Gray, and Shojiro Nishio, editors, *VLDB’95, Proceedings of 21th International Conference on Very Large Data Bases, September 11-15, 1995, Zurich, Switzerland.*, pages 407–419. Morgan Kaufmann, 1995.
- [20] Xuan Zhou and James Geller. Raising, to enhance rule mining in web marketing with the use of an ontology. In *Data Mining with Ontologies: Implementations, Findings, and Frameworks*, pages 18–36. IGI Global, 2008.
- [21] Marcos Aurélio Domingues and Solange Oliveira Rezende. Using taxonomies to facilitate the analysis of the association rules. *CoRR*, abs/1112.1734, 2011.
- [22] Claudia Marinica and Fabrice Guillet. Knowledge-based interactive postmining of association rules using ontologies. *IEEE Trans. Knowl. Data Eng.*, 22(6):784–797, 2010.
- [23] Petar Ristoski and Heiko Paulheim. Rdf2vec: RDF graph embeddings for data mining. In Paul T. Groth, Elena Simperl, Alasdair J. G. Gray, Marta Sabou, Markus Krötzsch, Freddy Lécué, Fabian Flöck, and Yolanda Gil, editors, *The Semantic Web - ISWC 2016 - 15th International Semantic Web Conference, Kobe, Japan, October 17-21, 2016, Proceedings, Part I*, volume 9981 of *Lecture Notes in Computer Science*, pages 498–514, 2016.
- [24] Minjun Chen, Ayako Suzuki, Shraddha Thakkar, Ke Yu, Chuchu Hu, and Weida Tong. DILrank: the largest reference drug list ranked by the risk for developing drug-induced liver injury in humans. *Drug Discov Today*, 21(4):648–653, 2016.
- [25] Fabian M. Suchanek, Serge Abiteboul, and Pierre Senellart. PARIS: probabilistic alignment of relations, instances, and schema. *PVLDB*, 5(3):157–168, 2011.
- [26] Petar Ristoski and Heiko Paulheim. Feature selection in hierarchical feature spaces. In Saso Dzeroski, Pance Panov, Dragi Kocev, and Ljupco Todorovski, editors, *Discovery Science - 17th International Conference, DS 2014, Bled, Slovenia, October 8-10, 2014. Proceedings*, volume 8777 of *Lecture Notes in Computer Science*, pages 288–300. Springer, 2014.
- [27] Claudia d’Amato, Steffen Staab, and Nicola Fanizzi. On the influence of description logics ontologies on conceptual similarity. In Aldo Gangemi and Jérôme Euzenat, editors, *Knowledge Engineering: Practice and Patterns, 16th International Conference, EKAW 2008, Acitrezza, Italy, September 29 - October 2, 2008. Proceedings*, volume 5268 of *Lecture Notes in Computer Science*, pages 48–63. Springer, 2008.
- [28] Petar Ristoski and Heiko Paulheim. A comparison of propositionalization strategies for creating features from linked open data. In Ilaria Tiddi, Mathieu d’Aquin, and Nicolas Jay, editors, *Proceedings of the 1st Workshop on Linked Data for Knowledge Discovery co-located with European Conference on Machine Learning and Principles and Practice of Knowledge Discovery in Databases (ECML PKDD 2014), Nancy, France, September 19th, 2014.*, volume 1232 of *CEUR Workshop Proceedings*. CEUR-WS.org, 2014.

$(-k)$ -CRITICAL TREES AND k -MINIMAL TREES

Walid Marweni
Faculty of Sciences
Sfax University, Tunisia.
walid.marweni@gmail.com

ABSTRACT

In a graph $G = (V, E)$, a module is a vertex subset M of V such that every vertex outside M is adjacent to all or none of M . For example, \emptyset , $\{x\}$ ($x \in V$) and V are modules of G , called trivial modules. A graph, all the modules of which are trivial, is prime; otherwise, it is decomposable. A vertex x of a prime graph G is critical if $G - x$ is decomposable. Moreover, a prime graph with k non-critical vertices is called $(-k)$ -critical graph. A prime graph G is k -minimal if there is some k -vertex set X of vertices such that there is no proper induced subgraph of G containing X is prime. I. Boudabbous proposes to find the $(-k)$ -critical graphs and k -minimal graphs for some integer k even though in a particular case of graphs. This paper answers I. Boudabbous's question. First, it describes the $(-k)$ -critical tree. As a corollary, we determine the number of nonisomorphic $(-k)$ -critical tree with n vertices where $k \in \{1, 2, \lfloor \frac{n}{2} \rfloor\}$. Second, it gives a complete characterization of the k -minimal tree. As a corollary, we determine the number of nonisomorphic k -minimal tree with n vertices where $k \leq 3$.

Keywords Graphs, tree · module, prime · critical vertex, minimal.

1 Introduction

1.1 Presentation of the results

Our work lies on the framework of graph theory with a special focus on decomposition problems. A *graph* $G = (V(G), E(G))$ (or $G = (V, E)$) consists of a finite set V of *vertices* together with a set E of pairs of distinct vertices, called *edges*. On the one side, let $G = (V, E)$ be a graph. The *neighborhood* of x in G , denoted by $N_G(x)$ or simply $N(x)$, is the set $N_G(x) = \{y \in V \setminus \{x\} : \{x, y\} \in E\}$. The *degree* of x in G , denoted by $d_G(x)$ (or $d(x)$), is the cardinal of $N_G(x)$. A vertex x with degree one is called a *leaf*, its adjacent vertex is called a *support* vertex and it is denoted by x^+ . If x is a support vertex in G admits a unique leaf neighbor, this leaf is denoted by x^- . The set of leaves and support vertices in a graph G is denoted by $\mathcal{L}(G)$ and $\mathcal{S}(G)$ respectively. An *internal* vertex is a vertex with a degree greater than or equal to 2. The *distance* between two vertices u and v in G is the length (number of edge) of the shortest path connecting them and is denoted by $dist_G(u, v)$ or simply $dist(u, v)$. The notation $x \sim Y$ for each $Y \subseteq V \setminus \{x\}$ means x is adjacent to all or none vertex of Y . The negation is denoted by $x \not\sim Y$.

On the other side, given a graph $G = (V, E)$, with each subset X of V , the graph $G[X] = (X, E \cap \binom{X}{2})$ is an *induced subgraph* of G . For $X \subseteq V$ (resp. $x \in V$), the induced subgraph $G[V \setminus X]$ (resp. $G[V \setminus \{x\}]$) is denoted by $G - X$ (resp. $G - x$). The notions of isomorphism and embedding are defined in the following way. Two graphs $G = (V, E)$ and $G' = (V', E')$ are *isomorphic*, which is denoted by $G \simeq G'$, if there is an *isomorphism* from G onto G' , i.e., a bijection from V onto V' such that for all $x, y \in V$, $\{x, y\} \in E$ if and only if $\{f(x), f(y)\} \in E'$. We say that a graph G' *embeds* into a graph G if G' is isomorphic to an induced subgraph of G . Otherwise, we say that G *omits* G' . Given a graph G and a one-to-one function f defined on a set containing $V(G)$, we denote by $f(G)$ the graph $(f(V(G)); f(E(G))) = (f(V(G)); \{\{f(x), f(y)\} : \{x, y\} \in E(G)\})$. A nonempty subset C of V is a *connected component* of G if for $x \in C$ and $y \in V \setminus C$, $\{x, y\} \notin E$ and if for $x \neq y \in C$, there is a sequence $x = x_0, \dots, x_n = y$ of C elements such that for each $0 \leq i \leq n - 1$, $\{x_i, x_{i+1}\} \in E$. A vertex x of G is *isolated* if

$\{x\}$ constitutes a connected component of G . The set of the connected components of G is a partition of V , denoted $\mathcal{C}(G)$. The graph G is *connected* if it has at most one connected component of G . Otherwise, it is called *non-connected*. For example, a *tree* is a connected graph in which any two vertices are connected by exactly one path.

Add to this, given a graph $G = (V, E)$. A subset M of V is a *module* of G if every vertex outside M is adjacent to all or none of M . This concept was introduced in [25] and independently under the name *interval* in [14, 18, 24] and an *autonomous* set in [16]. The empty set, the singleton sets, and the full set of vertices are *trivial modules*. A graph is *indecomposable* (or *primitive*) if all its modules are trivial; otherwise, it is decomposable. Therefore, indecomposable graphs with at least four vertices are prime graphs. This concept was developed in several papers e.g ([16, 18, 19, 21, 24, 26]), and is now presented in a book by Ehrenfeucht, Harju and Rozenberg [15]. Properties of the prime substructures of a given prime structures were developed by Schmerl and Trotter [24] in their fundamental paper. Indeed, several papers within the same framework have then appeared ([4, 6, 7, 8, 12, 15, 20, 17, 22, 23]). For instance, the *path* defined on $\mathbb{N}_n = \{1, \dots, n\}$, denoted by P_n , is prime for $n \geq 4$. A path with extremities x and y is referred to as (x, y) -path. For example, it easy to verify that each prime graph is connected.

The study of the hereditary aspect of the primality in the graphs revolve around the following general question. Given a prime graph G , is there always a proper prime subgraph in G ? This problem leads to the publication of many papers. A first result in this direction dates back to D. P. Sumner [26]: For every prime graph G , there exists $X \subseteq V(G)$ such that $|X| = 4$ and $G[X]$ is prime. In 1990, A. Ehrenfeucht and G. Rozenberg [16] has also affirmed that the prime graphs have the following ascendant hereditary property. Let X be a subset of a prime graph G such that $G[X]$ is prime. If $|V(G) \setminus X| \geq 2$, then there exist $x \neq y \in V(G) \setminus X$ such that $G[X \cup \{x, y\}]$ is prime. The latter result has been improved in 1993 by J. H. Schmerl and W. T. Trotter [24] as follows. For each prime graph of order n ($n \geq 7$) embeds a prime graph of order $n - 2$. It is then natural to ask the next question. Given a prime graph G of order n , is there always a prime subgraph of G of order $n - 1$? The answer to this question is negative and the prime graph G such that $G - x$ is decomposable for each $x \in V(G)$, is referred to as *critical graph*, is the counterexample. In 1993, J.H. Schmerl and W.T. Trotter [24] has characterized the critical graphs.

Consider now a prime graph $G = (V, E)$. A vertex x of G is said to be *critical* if $G - x$ is decomposable, otherwise x is a *non-critical* vertex. The set of the non-critical vertices of G is denoted by $\sigma(G)$. Moreover, if G admits k non-critical vertices is then called a $(-k)$ -critical graph. Recently, Y.Boudabbous and Ille [11] asked about the description of the (-1) -critical graphs. Their question was solved by H. Belkhechine, I. Boudabbous and M. Baka Elayech [5] in the case of graph. More recently, I. Boudabbous, J. Dammak and M. Yaich gave a new approach in order to characterize the (-1) -critical graphs [9]. In 2020, I. Boudabbous and W. Marweni described the triangle-free prime graphs having at most two non critical vertices [10].

Another important tool in this work is the notion of *minimal* graphs defined a follows. A prime graph G is *minimal* for a vertex subset X , or X -*minimal*, if no proper induced subgraph of G containing X is prime. A graph G is k -*minimal* if it is minimal for some k -element set of k elements. A. Cournier and P. Ille [14] in 1998 characterized the 1-minimal and 2-minimal graphs. Recently, M. Alzohairi and Y. Boudabbous characterized the 3-minimal triangle-free graphs [2]. In 2015, M. Alzohairi characterized the triangle-free graphs which are minimal for some nonstable 4-vertex subset [1]. Motivated by this two fundamental notions, I. Boudabbous proposes to find the $(-k)$ -critical graphs and k -minimal graphs for some integer k even though in a particular case of graphs. This work resolves what was requested by I. Boudabbous. However, we describe the prime tree having exactly k non-critical vertices. Recall that $\lfloor x \rfloor$ denotes the greatest integer $\leq x$. We obtain:

Theorem 1.1 *Let $T = (V, E)$ be a tree with at least 5 vertices and $\{x_1, \dots, x_k\}$ be a vertex subset of G where k is an integer.*

T is $(-k)$ -critical and $\sigma(T) = \{x_1, \dots, x_k\}$ (see Figure 1 (a)) if and only if T satisfies the four assertions.

1. *For each $x \neq y \in \mathcal{L}(T)$, $dist(x, y) \geq 3$,*
2. *$\{x_1, \dots, x_k\} \subseteq \mathcal{L}(T)$ and $1 \leq k \leq \lfloor \frac{n}{2} \rfloor$,*
3. *For each $x \in \mathcal{L}(T) \setminus \{x_1, \dots, x_k\}$, there is a unique $i \in \{1, \dots, k\}$ such that $dist(x, x_i) = 3$ and $d(x^+) = 2$,*
4. *If $d(x_i^+) = 2$ where $i \in \{1, \dots, k\}$, then for all $x \in \mathcal{L}(T) \setminus \{x_i\}$, $dist(x_i, x) \geq 4$.*

Second, we describe the k -minimal trees. We obtain:

Theorem 1.2 *Let $T = (V, E)$ be a tree with at least 5 vertices and let $\{x_1, \dots, x_k\}$ be a vertex subset of G where k is a strictly positive integer.*

T is minimal for $\{x_1, \dots, x_k\}$ (see Figure 1 (b)) if and only if T satisfies the three assertions.

1. For each $x \neq y \in \mathcal{L}(T)$, $\text{dist}(x, y) \geq 3$.
2. For each $x \in \mathcal{L}(T)$, $\{x, x^+\} \cap \{x_1, \dots, x_k\} \neq \emptyset$.
3. If $x_i \in \mathcal{S}(T)$ and $x_i^- \notin \{x_1, \dots, x_k\}$ where $i \in \{1, \dots, k\}$, then $d(x_i) = 2$ and there is $j \neq i \in \{1, \dots, k\}$ such that $x_j \in \mathcal{L}(T)$ and $d(x_i, x_j) = 2$.

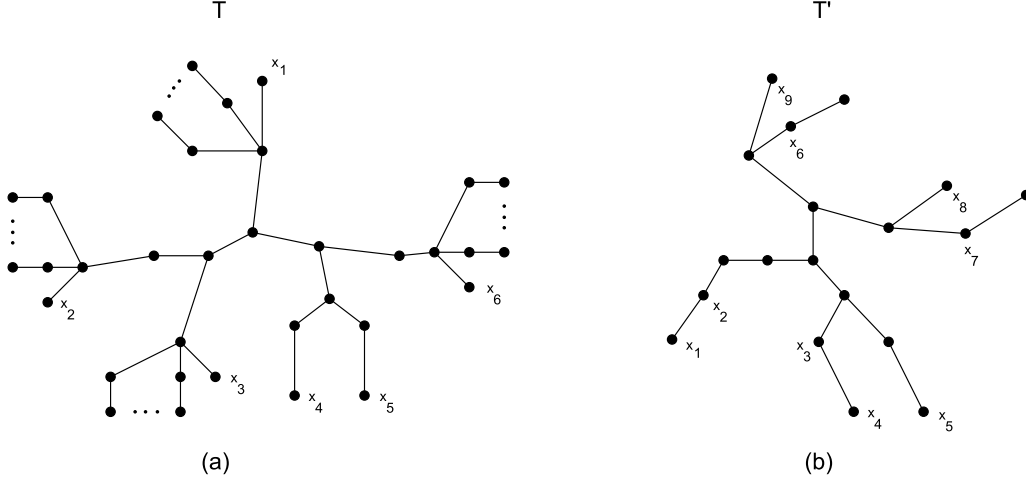

Figure 1: (a) T is (-6) -critical and $\sigma(T) = \{x_1, \dots, x_6\}$. (b) T' is minimal for $\{x_1, \dots, x_9\}$.

2 Proof of Theorem 1.1:

We recall the characterization of the prime tree due to M. Alzohairi and Y. Boudabbous.

Lemma 2.1 ([2])

1. If M is a nontrivial module in a decomposable tree T , then M is a stable set of T . Moreover, the elements of M are leaves of T .
2. A tree with at least four vertices is prime if and only if any two distinct leaves have not the same neighbor.

As an immediate consequence of Lemma 2.1, we have the following result.

Corollary 2.2 Let $T = (V, E)$ be a tree. T is prime if and only if $d(x, y) \geq 3$, for each $x \neq y \in \mathcal{L}(T)$.

The following observation follows immediately from Lemma 2.1.

Observation 2.3 Let $T = (V, E)$ be a prime tree with n vertices. Then $|\mathcal{S}(T)| = |\mathcal{L}(T)| \leq \lfloor \frac{n}{2} \rfloor$.

Now, we establish the next lemma that will be needed in the sequel.

Lemma 2.4 Let $T = (V, E)$ be a prime tree and $x \in \mathcal{L}(T)$. If $T - x$ is decomposable, then there is $y \in \mathcal{L}(T) \setminus \{x\}$ such that $\{y, x^+\}$ is the unique module of $T - x$.

Proof: Consider a prime tree $T = (V, E)$ and $x \in \mathcal{L}(T)$. Assume that $T - x$ is a decomposable tree, by Lemma 2.1, there exist two distinct leaves of $T - x$, said y and z , have the same neighbor. Then $\{y, z\}$ is a module of $T - x$. Since T is a prime tree, $x \not\sim \{y, z\}$. Thus $x^+ \in \{y, z\}$. Without loss of generality, we may assume that $x^+ = z$ and we have $y \in \mathcal{L}(T)$. Since T is prime and $y \in \mathcal{L}(T)$, then $\text{dist}(y, u) \geq 3$ for each $u \neq y \in \mathcal{L}(T)$. Therefore, $\{y, x^+\}$ is the unique module of $T - x$. \square

Proof of Theorem 1.1. Consider a tree $T = (V, E)$ with n vertices where $n \geq 5$ and $\{x_1, \dots, x_k\}$ is a subset of V where k is a strictly positive integer. Assume that T is $(-k)$ -critical and $\sigma(T) = \{x_1, \dots, x_k\}$. Since T is prime, by Corollary 2.2, we have for each

$x \neq y \in \mathcal{L}(T)$, $dist(x, y) \geq 3$. Hence T satisfies the condition (1) of Theorem 1.1.

Moreover, let $x \in V \setminus \mathcal{L}(T)$, x is an internal vertex of T and $T - x$ is a non-connected graph. Then $T - x$ is decomposable and $x \notin \sigma(T)$. Thus, $\{x_1, \dots, x_k\} \subseteq \mathcal{L}(T)$. As T is prime, by Observation 2.3, we have $1 \leq k \leq \lfloor \frac{n}{2} \rfloor$. Hence T satisfies the condition (2) of Theorem 1.1.

Now, consider $x \in \mathcal{L}(T) \setminus \{x_1, \dots, x_k\}$, then $T - x$ is a decomposable tree. By Lemma 2.4, there is $y \in \mathcal{L}(T) \setminus \{x\}$ such that $\{y, x^+\}$ is the only module of $T - x$. Clearly $dist(x, y) = 3$ and $d(x^+) = 2$. Now, prove that $y \in \sigma(T)$. To the contrary, suppose that $y \notin \sigma(T)$, implying that $T - y$ is a decomposable tree. Using again Lemma 2.4, there is $z \in \mathcal{L}(T) \setminus \{y\}$ such that $\{z, y^+\}$ is the unique module of $T - y$. Thus, $d(y^+) = 2$ and $dist(y, z) = 3$. Implies that $z = x$ and we obtain that T is with 4 vertices; which contradicts the fact that T is a tree have at least 5 vertices. Hence, $y \in \sigma(T)$. Therefore, T satisfies the condition (3) of Theorem 1.1.

Besides, assume that there is $i \in \{1, \dots, k\}$ such that $d(x_i^+) = 2$. Then, $T - x_i$ is a prime tree and $x_i^+ \in \mathcal{L}(T - x_i)$. By Corollary 2.2, for all $y \in \mathcal{L}(T - x_i)$, $dist(x_i^+, y) \geq 3$. Since $\mathcal{L}(T - x_i) \setminus \{x_i^+\} = \mathcal{L}(T) \setminus \{x_i\}$, then for each $y \neq x_i \in \mathcal{L}(T)$, $dist(x_i, y) \geq 4$. Hence, T satisfies the condition (4) of Theorem 1.1.

Conversely, assume that T satisfies the conditions (1)-(4) of Theorem 1.1. Proving that, T is $(-k)$ -critical and $\sigma(T) = \{x_1, \dots, x_k\}$. Since for each $x \neq y \in \mathcal{L}(T)$, $dist(x, y) \geq 3$ and by Corollary 2.2, T is prime. Clearly, if $x \in V \setminus \mathcal{L}(T)$, $T - x$ is a non-connected graph. Thus, $T - x$ is decomposable and hence x is a critical vertex.

Moreover, if $x \in \mathcal{L}(T) \setminus \{x_1, \dots, x_k\}$, by assertion (3), there is a unique $i \in \{1, \dots, k\}$ such that $dist(x, x_i) = 3$ and $d(x^+) = 2$. Then, $\{x^+, x_i\}$ is a module of $T - x$. Hence for each $x \in \mathcal{L}(T) \setminus \{x_1, \dots, x_k\}$, $T - x$ is decomposable and then x is a critical vertex.

Now, given $i \in \{1, \dots, k\}$. If $d(x_i^+) \geq 3$, then $\mathcal{L}(T) \setminus \{x_i\} = \mathcal{L}(T - x_i)$. According to first hypothesis of Theorem 1.1, for each $x \neq y \in \mathcal{L}(T - x_i)$, $dist(x, y) \geq 3$. By Corollary 2.2, $T - x_i$ is a prime tree.

Assume now that $d(x_i^+) = 2$. Suppose that $T - x_i$ is a decomposable tree, then by Lemma 2.4 there is a unique $y \neq x_i \in \mathcal{L}(T)$ such that $\{y, x_i^+\}$ is the unique module of $T - x_i$. So $dist(y, x_i) = 3$; which contradicts the hypothesis 4 of Theorem 1.1. Hence, $T - x_i$ is prime. Consequently, T is $(-k)$ -critical and $\sigma(T) = \{x_1, \dots, x_k\}$. \square

Our second objective in this section is to determine the number of nonisomorphic $(-k)$ -critical trees with $n \geq 5$ vertices where $k \in \{1, 2, \lfloor \frac{n}{2} \rfloor\}$. According to the characterization of critical graphs [24], P_4 is the a unique critical trees. To state the the number of nonisomorphic $(-k)$ -critical trees where $k \in \{1, 2, \lfloor \frac{n}{2} \rfloor\}$, we introduce for all $n \in \mathbb{N}$, the one-to-one function:

$$T_n : \mathbb{N} \rightarrow \mathbb{N} \\ p \mapsto p + n$$

Now, we introduce also the following trees.

- For integers $m \geq 2$, let A_{2m+1} be the tree defined on $\{0, \dots, 2m\}$ and $E(A_{2m+1}) = \{\{0, i\}, \{i, i+m\} : 1 \leq i \leq m\}$ (see Figure 2).
- For integers $k \geq 4$, $t \geq 1$, let $P_{k,t}$ be the tree defined on $\{1, \dots, 2t+k\}$ and $E(P_{k,t}) = E(T_{2t}(P_k)) \cup \{\{2i-1, 2i\} : 1 \leq i \leq t\} \cup \{\{2t+2, 2i\} : 1 \leq i \leq t\}$ (see Figure 3).
- For integers $m \geq 4$, $n_1 \geq 1$, $n_2 \geq 1$, for each $p \in \{1, 2\}$, $s_p = n_1 + \dots + n_p$. Let P_{m,n_1,n_2} be the tree defined on $\{1, \dots, 2s_2 + m\}$ and $E(P_{m,n_1,n_2}) = E(T_{2s_2}(P_m)) \cup \{\{2i-1, 2i\} : 1 \leq i \leq s_2\} \cup \{\{2s_2+2, 2i\}, \{2s_2+m-1, 2j\} : 1 \leq i \leq n_1 \text{ and } n_1 < j \leq s_2\}$ (see Figure 4).

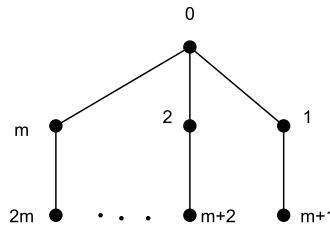

Figure 2: The tree A_{2m+1}

Proposition 2.5 1. Up to isomorphisms, the (-1) -critical trees with n vertices are the tree $P_{4, \frac{n-4}{2}}$ where n is an even integers ≥ 6 .

2. Up to isomorphisms, the $(-\lfloor \frac{n}{2} \rfloor)$ -critical trees with n vertices are the tree A_n where n is odd integers ≥ 5 .

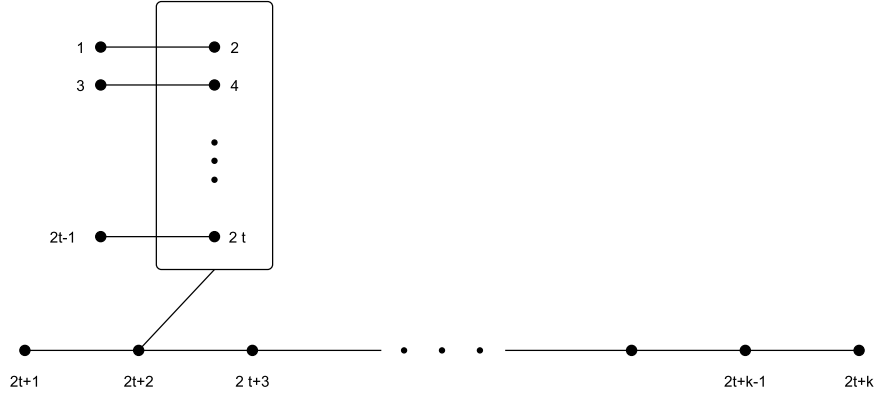

Figure 3: The tree $P_{k,t}$

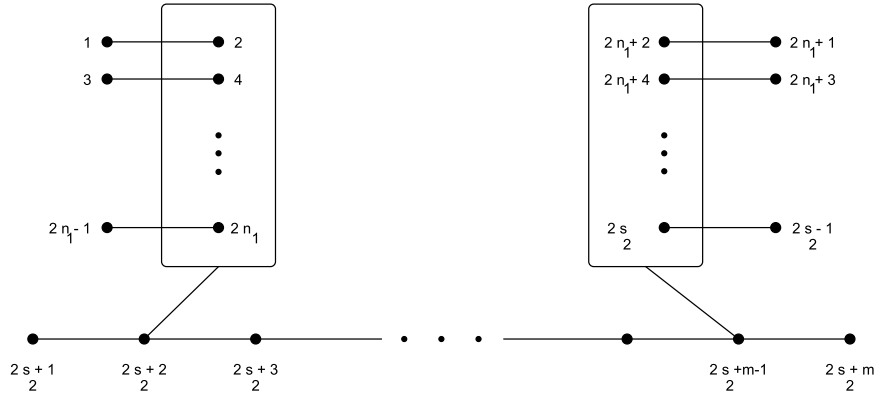

Figure 4: The tree P_{m,n_1,n_2}

Proof:

1. Clearly, by Theorem 1.1, $P_{4, \frac{n-4}{2}}$ is a (-1) -critical tree where $n \geq 6$ and $\sigma(P_{4, \frac{n-4}{2}}) = \{n-3\}$. Now, we consider a (-1) -critical tree T with $n \geq 5$ vertices such that $\sigma(T) = \{x_1\}$. By Theorem 1.1, $x_1 \in \mathcal{L}(T)$. If $x \neq x_1 \in \mathcal{L}(T)$, then by assertion (3) of Theorem 1.1 $dist(x, x_1) = 3$ and $d(x^+) = 2$. To the contrary, suppose that $|\mathcal{L}(T)| = 2$. Since T is prime, then T is isomorphic to P_4 ; which a contradicts the fact that T have at least 5 vertices. Hence, $|\mathcal{L}(T)| \geq 3$. By assertion (3), for each $y \in \mathcal{L}(T)$, $dist(y, x_1) = 3$ and $d(y^+) = 2$. Thus, T is isomorphic to $P_{4, \frac{n-4}{2}}$ where $n \geq 6$ is an even integers.
2. By Theorem 1.1, A_{2m+1} is $(-\lfloor \frac{2m+1}{2} \rfloor)$ -critical and $\sigma(A_{2m+1}) = \mathcal{L}(A_{2m+1})$ where $m \geq 2$. Now, we consider a $(-\lfloor \frac{n}{2} \rfloor)$ -critical tree T with $n \geq 5$ vertices. Using Theorem 1.1, $\sigma(T) \subseteq \mathcal{L}(T)$ implying that $|\sigma(T)| = \lfloor \frac{n}{2} \rfloor \leq |\mathcal{L}(T)|$. By Observation 2.3, $|\mathcal{L}(T)| = |\mathcal{S}(T)| \leq \lfloor \frac{n}{2} \rfloor$ and so $|\mathcal{L}(T)| = |\mathcal{S}(T)| = \lfloor \frac{n}{2} \rfloor$. Now, we will prove that n is odd. To the contrary, suppose that n is even, then $|\mathcal{L}(T)| = |\mathcal{S}(T)| = \frac{n}{2}$. Hence, $V(T) = \mathcal{L}(T) \cup \mathcal{S}(T)$. Since $T[\mathcal{S}(T)]$ is a tree, there exists a vertex $y \in \mathcal{S}(T)$ with $d_{T[\mathcal{S}(T)]}(y) = 1$. Hence $d_T(y) = 2$. We may assume that $N(y) = \{y^-, x\}$ where $x \in \mathcal{S}(T)$. Thus $\{y, x^-\}$ is a module of $T - y^-$; which contradicts the fact that y^- is a not critical vertex. Accordingly, n is odd, $|\mathcal{L}(T)| = |\mathcal{S}(T)| = \frac{n-1}{2}$.

and $V(T) = \mathcal{L}(T) \cup \mathcal{S}(T) \cup \{z\}$. We can assume that $\mathcal{L}(T) = \{x_1, \dots, x_{\lfloor \frac{n-1}{2} \rfloor}\}$ and $\mathcal{S}(T) = \{x_1^+, \dots, x_{\lfloor \frac{n-1}{2} \rfloor}^+\}$. Since $T[\mathcal{S}(T) \cup \{z\}]$ is a tree, there exists a vertex $x_i^+ \in \mathcal{S}(T)$ where $1 \leq i \leq \frac{n-1}{2}$ with $d_{T[\mathcal{S}(T)]}(x_i^+) = 1$ and so $d_T(x_i^+) = 2$. By Theorem 1.1, $dist(x_i, x_j) \geq 4$ for each $j \neq i \in \{1, \dots, \frac{n-1}{2}\}$. Hence, T is isomorphic to A_n where $n \geq 5$. \square

As a consequence of Theorem 1.1, we have the following result.

Proposition 2.6 *Up to isomorphisms, the (-2) -critical trees with $n \geq 5$ vertices are the trees $P_n, P_{k,t}$ where $k \geq 4, t \geq 1$ and $n = k + 2t$, and P_{m,n_1,n_2} where $m \geq 4, n_1, n_2 \geq 1$ and $n = m + 2(n_1 + n_2)$.*

Proof: By Theorem 1.1, $P_n, P_{k,t}$ where $k \geq 4, t \geq 1$, and P_{m,n_1,n_2} where $m \geq 4, n_1, n_2 \geq 1$ are (-2) -critical trees and $\sigma(P_n) = \{1, n\}, \sigma(P_{k,t}) = \{2t + 1, 2t + k\}$, and $\sigma(P_{m,n_1,n_2}) = \{2s_2 + 1, 2s_2 + m\}$. Now, assume that T is a (-2) -critical tree with $n \geq 5$ vertices such that $\sigma(T) = \{x_1, x_2\}$. By Theorem 1.1, $x_1, x_2 \in \mathcal{L}(T)$. As T is a prime tree, then the (x_1, x_2) -path is isomorphic to P_k where $k \geq 4$. If $|\mathcal{L}(T)| = 2$, then T is isomorphic to P_n and $n = k$. Assume that $|\mathcal{L}(T)| \geq 3$, then by Theorem 1.1 for each $x \in \mathcal{L}(T) \setminus \{x_1, x_2\}$, there is a unique $i \in \{1, 2\}$ such that $dist(x, x_i) = 3$ and $d(x^+) = 2$. Hence, T is isomorphic to $P_{k,t}$ where $k \geq 4, t \geq 1$ and $n = k + 2t$ or T is isomorphic to P_{k,n_1,n_2} where $k \geq 4, n_1, n_2 \geq 1$ and $n = k + 2(n_1 + n_2)$. \square

Theorem 2.7 *The number of nonisomorphic (-2) -critical trees with n vertices equals:*

- $\left\lfloor \frac{n}{4} \right\rfloor^2 - 1$ if $n \equiv 0 \pmod{4}$.
- $\left\lfloor \frac{n}{4} \right\rfloor^2$ if $n \equiv 1 \pmod{4}$.
- $\left\lfloor \frac{n}{4} \right\rfloor \left(\left\lfloor \frac{n}{4} \right\rfloor + 1 \right) - 1$ if $n \equiv 2 \pmod{4}$.
- $\left\lfloor \frac{n}{4} \right\rfloor \left(\left\lfloor \frac{n}{4} \right\rfloor + 1 \right)$ otherwise.

Proof: At the beginning, it is not difficult to verify that there are no two isomorphic different trees in the union $\{P_m : m \geq 5\} \cup \{P_{k,t} : k \geq 5, t \geq 1\} \cup \{P_{m,n_1,n_2} : m \geq 4, n_1 \geq 1 \text{ and } n_2 \geq 1\}$.

By Proposition 2.6, P_5 is the unique (-2) -critical tree with five vertex and P_6 is the unique (-2) -critical tree with six vertices, then the result holds.

Now, assume that $n \geq 7$. By Proposition 2, the nonisomorphic (-2) -critical trees with n vertices are P_n , the family of $P_{k,t}$ where $t \geq 1, k \geq 5$, and $n = 2t + k$, or the family of P_{m,n_1,n_2} where $1 \leq n_1 \leq n_2, m \geq 4$, and $n = 2(n_1 + n_2) + m$. Therefore, it suffices to determine the number of the family of $P_{k,t}$ and the number of the family of P_{m,n_1,n_2} .

Let $S_m = \{(n_1, n_2) \in \mathbb{N} \times \mathbb{N} : 1 \leq n_1 \leq n_2, n_1 + n_2 = \frac{n-m}{2}\}$ where $4 \leq m \leq n - 4$ and let $C_t = \{k \in \mathbb{N} : 5 \leq k \text{ and } k = n - 2t\}$ where $1 \leq t \leq \frac{n-5}{2}$. Since $n - m = 2(n_1 + n_2)$, it clear that n and m are of the some parity. Hence, we distinguish two cases.

Case 1: If $n = 2p$ where $4 \leq p$ and $m = 2q$ where $2 \leq q \leq p - 2$.

Consider $S = \bigcup_{q=2}^{p-2} S_{2q}$ and $C = \bigcup_{t=1}^{p-3} C_t$. First, clearly that the number of the family of $P_{k,t}$ is the cardinality of the set

C . Moreover, it is clear that $|C_t| = 1$ where $1 \leq t \leq p - 3$. Hence, $|C| = \sum_{t=1}^{p-3} |C_t| = p - 3$. Second, obviously the

number of the family of P_{m,n_1,n_2} is the cardinality of the set S . Furthermore, we have $|S| = \sum_{q=2}^{p-2} |S_{2q}|$. It is easy to see

that for each $2 \leq q \leq p - 2, |S_{2q}| = P_2(\frac{n-2q}{2})$, where $P_i(j)$ is the number of partitions of j to i parts. Recall that for

an integer $k \geq 3$, $P_2(k) = \lfloor \frac{k}{2} \rfloor$ where $\lfloor x \rfloor$ is the greatest integer $\leq x$ [3]. We have then

$$\begin{aligned}
|S| &= \sum_{q=2}^{p-2} P_2\left(\frac{n-2q}{2}\right) \\
&= \sum_{q=2}^{p-2} \left\lfloor \frac{n-2q}{4} \right\rfloor \\
&= \sum_{q=2}^{p-2} \left\lfloor \frac{\frac{n}{2}-q}{2} \right\rfloor \\
&= \sum_{i=0}^{p-2} \left\lfloor \frac{i}{2} \right\rfloor. \\
&= \begin{cases} (k-1)^2 & \text{if } p = 2k, \\ (k-1)k & \text{if } p = 2k+1. \end{cases}
\end{aligned}$$

Case 2: If $n = 2p + 1$ where $4 \leq p$ and $m = 2q + 1$ where $2 \leq q \leq p - 2$. Let $S = \bigcup_{q=2}^{p-2} S_{2q+1}$ and $C = \bigcup_{t=1}^{p-2} C_t$.

Clearly, the number of the family of $P_{k,t}$ is the cardinality of the set C . Hence, $|C| = \sum_{t=1}^{p-2} |C_t| = p - 2$. In addition,

the number of the family of P_{m,n_1,n_2} is the cardinality of the set S . We have $|S| = \sum_{q=2}^{p-2} |S_{2q+1}|$.

Since for each $2 \leq q \leq p - 2$, $|S_{2q+1}| = P_2\left(\frac{(n-1)-2q}{2}\right)$. In the same manner of case 1, if $p = 2k$ where $k \geq 2$, then $|S| = (k - 1)^2$. Otherwise, $|S| = (k - 1)k$.

Consequently, the number of nonisomorphic (-2) -critical trees with n vertices equals:

$$\begin{cases} \left\lfloor \frac{n}{4} \right\rfloor^2 - 1 & \text{if } n \equiv 0 \pmod{4}, \\ \left\lfloor \frac{n}{4} \right\rfloor^2 & \text{if } n \equiv 1 \pmod{4}, \\ \left\lfloor \frac{n}{4} \right\rfloor \left(\left\lfloor \frac{n}{4} \right\rfloor + 1 \right) - 1 & \text{if } n \equiv 2 \pmod{4}, \\ \left\lfloor \frac{n}{4} \right\rfloor \left(\left\lfloor \frac{n}{4} \right\rfloor + 1 \right) & \text{if } n \equiv 3 \pmod{4}. \end{cases}$$

□

3 Proof of Theorem 1.2:

We have two major objectives all along this section. First, to characterize the k -minimal trees. Second, to determine the number of nonisomorphic k -minimal trees with n vertices where $k \in \{1, 2, 3\}$.

Proof of Theorem 1.2. Let $T = (V, E)$ be a tree with $n \geq 5$ vertices and let $\{x_1, \dots, x_k\}$ be a vertex subset of G where k is a strictly positive integer. Assume that T is minimal for $\{x_1, \dots, x_k\}$. Since T is prime, it satisfies the first condition of Theorem 1.2. Suppose to the contrary that there is $y \in \mathcal{L}(T)$ such that $\{y, y^+\} \cap \{x_1, \dots, x_k\} = \emptyset$. Since $T - y$ is a decomposable tree, by Lemma 2.4, there is $x \in \mathcal{L}(T)$ such that $\{x, x^+\}$ is a module of $T - y$. Thus $d(y^+) = 2$ and $d(x, y) = 3$. If $x \notin \{x_1, \dots, x_k\}$, then $T - x$ is a decomposable tree. By using again Lemma 2.4, $d(x^+) = 2$ and so T is isomorphic to P_4 ; which contradicts the fact $n \geq 5$.

Moreover, assume that $x \in \{x_1, \dots, x_k\}$ and $d(x^+) \geq 3$, then $\mathcal{L}(T) \setminus \{y\} = \mathcal{L}(T - \{y, y^+\})$. By Lemma 2.1, $T - \{y, y^+\}$ is a prime tree containing $\{x_1, \dots, x_k\}$; which contradicts the fact T is minimal for $\{x_1, \dots, x_k\}$. Hence, for each $x \in \mathcal{L}(T)$, $\{x, x^+\} \cap \{x_1, \dots, x_k\} \neq \emptyset$ and T satisfies the second condition of Theorem 1.2.

Now, assume that there is $x_i \in \mathcal{S}(T)$ and $x_i^- \notin \{x_1, \dots, x_k\}$ where $1 \leq i \leq k$. To the contrary, suppose that $d(x_i) \geq 3$, then $\mathcal{L}(T) \setminus \{x_i^-\} = \mathcal{L}(T - x_i^-)$. By Lemma 2.1, $T - x_i^-$ is a prime tree containing $\{x_1, \dots, x_k\}$; which is impossible. Hence $d(x_i) = 2$. To the contrary, suppose that for each $j \neq i \in \{1, \dots, k\}$ such that $x_j \in \mathcal{L}(T)$, $d(x_i, x_j) \geq 3$. Since $T - x_i^-$ is a decomposable tree, then by Lemma 2.4 there is $y \in \mathcal{L}(T)$ such that $d(x_i, y) = 2$ and hence $y \notin \{x_1, \dots, x_k\}$. By Condition 2, $y^+ \in \{x_1, \dots, x_k\}$ and so $d(y^+) = 2$. Thus T is isomorphic to P_4 ; which is impossible. Therefore, T satisfies the thirdly condition.

Conversely, let $T = (V, E)$ be a tree with $n \geq 5$ vertices. Since for each $x \neq y \in \mathcal{L}(T)$, $d(x, y) \geq 3$, T is a prime tree. Let X be a subset of V such that $\{x_1, \dots, x_k\} \subseteq X$ and $T[X]$ is prime. Consider $x \in \mathcal{L}(T)$. If $x \in \{x_1, \dots, x_k\}$, then $x \in X$.

Now, assume that $x \notin \{x_1, \dots, x_k\}$. To the contrary, suppose that $x \notin X$. By assertion (2) of Theorem 1.2, $x^+ \in \{x_1, \dots, x_k\}$. Since T satisfies the assertion (3) of Theorem 1.2, then $d(x^+) = 2$ and there is $i \in \{1, \dots, k\}$ such that $x_i \in \mathcal{L}(T)$ and $d(x_i, x^+) = 2$. Thus $\{x^+, x_i\}$ is a module of $T[X]$; which is impossible. Hence, $x \in X$. We conclude that $\mathcal{L}(T) \subset X$. Since $T[X]$ is a prime, its connected. Therefore, $T[X]$ is a tree containing $\mathcal{L}(T)$, then $X = V$. Hence, T is minimal for $\{x_1, \dots, x_k\}$. \square

The following corollary is an immediate consequence of Theorem 1.2.

Corollary 3.1 *For any distinct vertices x_1, x_2, \dots , and x_k in a prime tree H , there is an induced subtree T of H that contains $\{x_1, x_2, \dots, x_k\}$, and satisfied the assertions of Theorem 1.2.*

Our second result is to determine the number of nonisomorphic k -minimal trees with n vertices where $k \in \{1, 2, 3\}$. According to the characterization of 1-minimal and 2-minimal graphs, P_4 is the a unique 1-minimal tree and P_k , where $k \geq 4$, is the a unique 2-minimal tree [14].

To state the number of nonisomorphic 3-minimal trees with n vertices, we introduce the following tree.

- For positive integers k, m, n with $k \leq m \leq n$, let $S_{k,m,n}$ be the $(k + m + n + 1)$ -vertex tree with the union of the paths of lengths k, m , and n having common endpoint r . Let $a_1, \dots, a_k, b_1, \dots, b_m$, and c_1, \dots, c_n denote the other vertices on these paths, indexed by their distance from r (see Figure 5).

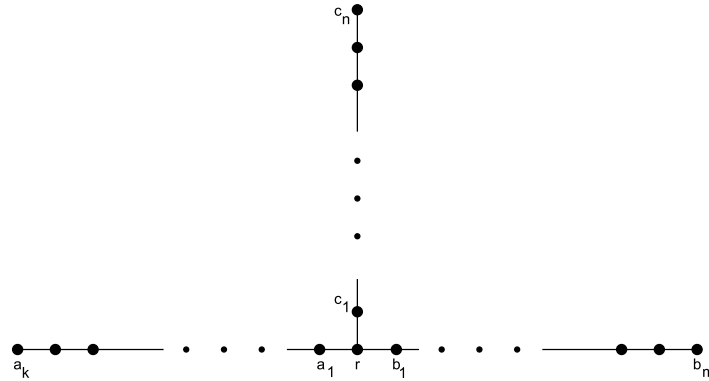

Figure 5: $S_{k,m,n}$

As an immediate consequence of Theorem 1.2, we have the following result which is already obtained by M. Alzohairi and Y. Boudabbous in [2].

Corollary 3.2 *Let x, y , and z be distinct vertices in a tree T . The tree T is minimal for $\{x, y, z\}$ if and only if T and $\{x, y, z\}$ have one of the following forms:*

1. $T \simeq P_4$.
2. $T \simeq P_k$ with $k \geq 5$ such that $\{x, y, z\}$ contains the leaves.
3. $T \simeq S_{k,m,n}$ with $m \geq 2$ such that x, y , and z are the leaves.
4. $T \simeq S_{1,2,n}$ such that $\{x, y, z\} = \{a_1, b_1, c_n\}$.

5. $T \simeq S_{1,2,2}$ such that $\{x, y, z\} = \{a_1, b_1, c_1\}$.

Proposition 3.3 *the number of nonisomorphic 3-minimal trees with n vertices equals:*

- 1 if $n \in \{4, 5\}$.
- 2 if $n = 6$.
- $\left\lceil \frac{(n-1)^2}{12} \right\rceil - \left\lfloor \frac{n-4}{2} \right\rfloor + \left\lfloor \frac{n-2}{2} \right\rfloor - 1$ if $n \geq 7$, where $[x]$ is the nearest integer to x .

Proof: At the beginning, it is not difficult to verify that there are no two isomorphic different graphs in the union $\{P_k : k \geq 4\} \cup \{S_{k,m,n} : m = 2\}$.

By Corollary 3.2, P_4 is the unique 3-minimal tree with four vertices and P_5 is the unique 3-minimal tree with five vertices. In addition, the only 3-minimal tree with six vertices are P_6 and $S_{1,2,2}$. Therefore, the result holds for $n \in \{4, 5, 6\}$.

Now, assume that $n \geq 7$. By Corollary 3.2, the non isomorphic 3-minimal n -vertex tree are P_n and the family of $S_{k,m,t}$, where $k \leq m \leq t$, $m \geq 2$, and $k + m + t + 1 = n$. Therefore, it suffices to prove that the cardinality of the set $S = \{(k, m, t) \in \mathbb{N} \times \mathbb{N} \times \mathbb{N} : 1 \leq k \leq m \leq t, m \geq 2, k + m + t = n - 1\}$ equals

$$\left\lceil \frac{(n-1)^2}{12} \right\rceil - \left\lfloor \frac{n-4}{2} \right\rfloor + \left\lfloor \frac{n-2}{2} \right\rfloor - 2.$$

Let $S_2 = \{(k, m, t) \in S : k \geq 2\}$. It is easy to see that $|S - S_2| = P_2(n-2) - 1$. Notice that $|S_2| = |\{(p, q, r) \in \mathbb{N} \times \mathbb{N} \times \mathbb{N} : 1 \leq p \leq q \leq r, p + q + r = n - 4\}| = P_3(n-4)$. Moreover, by [3], the number of partitions of k to with most 3 parts is equal to $\left\lceil \frac{(k+3)^2}{12} \right\rceil$. It follows that: $P_3(k) = \left\lceil \frac{(k+3)^2}{12} \right\rceil - \left\lfloor \frac{k}{2} \right\rfloor - 1$ [3]. Hence,

$$|S_2| = \left\lceil \frac{(n-1)^2}{12} \right\rceil - \left\lfloor \frac{n-4}{2} \right\rfloor - 1$$

and

$$|S - S_2| = \left\lfloor \frac{n-2}{2} \right\rfloor - 1.$$

Therefore,

$$|S| = \left\lceil \frac{(n-1)^2}{12} \right\rceil - \left\lfloor \frac{n-4}{2} \right\rfloor + \left\lfloor \frac{n-2}{2} \right\rfloor - 2.$$

□

4 Conclusion

The problems of finding the $(-k)$ -critical graphs and the k -minimal graphs seem to be challenging where k is an integer ($k \geq 2$). At least, we solve these problems in the particular case of trees. Also, we determine the number of nonisomorphic $(-k)$ -critical trees with $n \geq 5$ vertices where $k \in \{1, 2, \lfloor \frac{n}{2} \rfloor\}$. In addition, we count the number of nonisomorphic 3-minimal trees with n ($n \geq 4$) vertices.

References

- [1] M. Alzohairi. Triangle-free graphs which are minimal for some nonstable 4-vertex subset. In *Arab Journal of Mathematical Sciences*, pages 159–169. IEEE, 2015.
- [2] M. Alzohairi and Y. Boudabbous. 3-minimal triangle-free graphs. In *Discrete Mathematics*, pages 3–8. IEEE, 2014.
- [3] G. Andrews, K. Eriksson, *Integer Partitions*, Cambridge University Press, Cambridge, 2004.
- [4] H. Belkhechine and I. Boudabbous. Indecomposable tournaments and their indecomposable subtournaments on 5 and 7 vertices. In *Ars Combinatoria*, pages 493–504. IEEE, 2013.
- [5] H. Belkhechine, I. Boudabbous and J. Dammak. Les tournois (-1) -critiques. In *Communications in Mathematical Analysis*, pages 83–97. IEEE, 2007.
- [6] H. Belkhechine, I. Boudabbous and M.B. Elayech. les graphes (-1) -critiques. In *Ars combinatoria*, pages 293–319. IEEE, 2015.

- [7] H. Bouchaala, Y. Boudabbous and M. B. Elayech. Finite tournaments with a nonempty diamond's support. In *Graphs and Combinatorics*, pages 1653-1673. IEEE, 2013.
- [8] I. Boudabbous. Tournaments whose indecomposability graph admits a vertex cover of size 2. In *Ars Combinatoria*, pages 63–82. IEEE, 2016.
- [9] I. Boudabbous, J. Dammak and M. Yaich. Prime critically and prime covering. In *to appear in journal Mathematical reports*.
- [10] I. Boudabbous and W. Marweni. Description of the Triangle-free Prime Graphs Having at Most Two Non-Critical Vertices. In *Journal of Multi-Valued Logic and Soft Computing*, pages 77–103. IEEE, 2020.
- [11] Y. Boudabbous and P. Ille. Indecomposability graph and critical vertices of an indecomposable graph. In *Discrete Math*, pages 2839–2846. IEEE, 2009.
- [12] A. Boussaïri and A. Chaïchaâ. The 2-reconstructible indecomposable graphs. In *Comptes Rendus Mathématique*, pages 1–4. IEEE, 2007.
- [13] A. Breiner, J. Deogun and P. Ille. Partially critical indecomposable graphs. In *Contributions to Discrete Mathematics*, pages 40–59. IEEE, 2008.
- [14] A. Cournier and P. Ille. Minimal indecomposable graphs. In *Discrete Math*, pages 61–80. IEEE, 1998.
- [15] A. Ehrenfeucht, T. Harju and G. Rozenberg. The Theory of 2-Structures. In *A Framework for Decomposition and Transformation of Graphs, World Scientific, Singapore (1999)*.
- [16] A. Ehrenfeucht and G. Rozenberg. Primitivity is hereditary for 2-structures. In *Theoret. Comput. Sci.*, pages 343–358. IEEE, 1990.
- [17] M. B. Elayech, A. Salhi and H. Si Kaddour. The (-1) -critically duo-free tournaments. In *Ars Combinatoria*, pages 391–402. IEEE, 2005.
- [18] R. Fraïssé. L'intervalle en théorie des relations, ses généralisations, filtre intervallaire et clôture d'une relation. In *M. Pouzet and D. Richard eds, Order, Description and Roles, North-Holland, Amsterdam.(1984) 313-342*.
- [19] M. Habib. Substitution des structures combinatoires. In *Théorie et Algorithmes, Thèse d'état, Université Pierre et Marie Curie (1981)*.
- [20] P. Ille. Indecomposable graphs. In *Discrete Math*, pages 71–78. IEEE, 1997.
- [21] D. Kelly. Comparability graphs. In *I. Rival(Ed.), Graphs and Orders, Reidel, Dordrecht*, pages 3–40. IEEE, 1985.
- [22] M. Pouzet and I. Zaguia. On minimal prime graphs and posets. In *Order*, pages 357–375. IEEE, 2009.
- [23] M. Y. Sayar. Partially critical indecomposable tournaments and partially critical supports. In *Contributions to Discrete Mathematics*, pages 52–76. IEEE, 2011.
- [24] J.H. Schmerl and W.T. Trotter. Critically indecomposable partially ordered sets, graphs, tournaments and other binary relational structures. In *Discrete Math*, pages 191–205. IEEE, 1993.
- [25] J. Spinrad. P_4 -trees and substitution decomposition. In *Discrete Appl. Math.*, pages 263–291. IEEE, 1992.
- [26] D. P. Sumner. Graphs indecomposable with respect to the X -join. In *Discrete Math.*, pages 281–298. IEEE, 1973.

Unstable graphs and packing into fifth power

Mohamed Y. Sayar

Department of Mathematics
Faculty of Science of Sfax
Soukra Road km 4, PO Box 802, 3018 Sfax, Tunisia
sayar_mohamed@yahoo.fr

Tarak Louleb

Department of Mathematics
Faculty of Science of Sfax
Soukra Road km 4, PO Box 802, 3018 Sfax, Tunisia
tarekloleb@hotmail.com

Mohammad Alzohairi

Department of Mathematics
King Saud University
P. O. Box 2455 Riyadh 11451, Arabie saoudite
zohairi@ksu.edu.sa

ABSTRACT

In a graph $G := (V(G), E(G))$, a subset M of the vertex set $V(G)$ is a *module* (or *interval*, *clan*) of G if every vertex outside M is adjacent to all or none of M . The empty set, the singleton sets, and the full set of vertices are trivial modules. The graph G is *indecomposable* (or *prime*) if all its modules are trivial. If G is indecomposable, we say that an edge e of G is a removable edge if $G - e$ is indecomposable (here $G - e := (V(G), E(G) - \{e\})$). The graph G is said to be *unstable* if it has no removable edges. For a positive integer k , the k -th power G^k of a graph G is the graph obtained from G by adding an edge between all pairs of vertices of G with distance at most k . A graph G of order n (i.e. $|V(G)| = n$) is said to be p -placeable into G^k , if G^k contains p edge-disjoint copies of G . In this paper, we answer a question, suggested by Y. Boudabbous in a personal communication, concerning unstable graphs and packing into their fifth power as follows: First, we give a characterisation of the unstable graphs which is deduced from the results given by A. Ehrenfeucht, T. Harju and G. Rozenberg (The theory of 2-structures: a framework for decomposition and transformation of graphs). Second, we prove that every unstable graph G is 2-placeable into G^5 .

Keywords Indecomposable · Unstable · Packing · Graph power ·

1 Introduction

1.1 Graph theoretical definitions

All graphs considered in this paper are finite, undirected, without loops or multiple edges. For a graph G , we will use V , $(V(G))$, and E , $(E(G))$, to denote its vertex and edge sets respectively. For a positive integers n, m . We say that a graph G is of order n and size m , if $|V(G)| = n$ and $|E(G)| = m$. In this case, the graph G is called an (n, m) -graph. Given a graph G and $X \subset V$, the subgraph of G induced by X is denoted by $G[X]$. A graph G is called a discrete graph if $E(G) = \emptyset$. A graph G is called a path, denoted by P_n , if it is of the form: $V(P_n) = \{v_1, v_2, \dots, v_n\}$, $E(P_n) = \{v_1v_2, v_2v_3, \dots, v_{n-1}v_n\}$. A graph G is called a cycle, denoted by C_n , if it is of the form: $V(C_n) = \{v_1, v_2, \dots, v_n\}$, $E(C_n) = \{v_1v_2, v_2v_3, \dots, v_{n-1}v_n, v_nv_1\}$. A subset X of vertices of V is said to be k -subset if $|X| = k$. For an edge $e \in E$, we denote by $G - e$ the graph $(V(G), E(G) - e)$. Let x be a vertex of V . Then $N_G(x) = \{y \in V, xy \in E\}$. The graph G is connected if there exists a path between any two

distinct vertices of G . Otherwise, the graph G is disconnected. The distance between two vertices $u, v \in G$, denoted by $dist(u, v)$, is the minimum number of edges in a path connecting them. The diameter of G is the maximum distance between any two vertices of G . For a positive integer k , the k -th power G^k of a graph G is the graph obtained from G by adding an edge between all pairs of vertices of G with distance at most k .

1.2 Unstable graphs

In a graph G , a subset M of the vertex set V is a *module* (or *interval*, *clan*) of G if every vertex outside M is adjacent to all or none of M . The empty set, the singleton sets, and the full set of vertices are trivial modules. A graph is *indecomposable* (or *prime*) if all its modules are trivial. In the opposite case, we will say that G is *decomposable*.

Let G be an indecomposable graph. We say that $e \in E$ is removable edge if $G - e$ is indecomposable. The graph G is said to be *unstable* if it has no removable edges. Hence G is unstable if the removal of any edge $e \in E$ creates a nontrivial module in $G - e$.

Unstable graphs were introduced by Sumner (1973).

1.3 Graph packing problem

Let G be a graph of order n . Consider a permutation $\sigma: V(G) \rightarrow V(K_n)$, the map $\sigma^*: E(G) \rightarrow E(K_n)$ such that $\sigma^*(xy) = \sigma(x)\sigma(y)$ is the map induced by σ . Let G_1, \dots, G_k be k graphs of order n . We say that there is a packing of G_1, \dots, G_k (into the complete graph K_n) if there exist permutations $\sigma_i: V(G_i) \rightarrow V(K_n)$, where $i = 1, \dots, k$, such that $\sigma_i^*(E(G_i)) \cap \sigma_j^*(E(G_j)) = \emptyset$ for $i \neq j$, and here the map $\sigma_i^*: E(G_i) \rightarrow E(K_n)$ is the one induced by σ_i . A packing of k copies of the same graph G will be called a k -packing (or a k -placement) of G . In particular, a 2-packing of a graph G is a permutation σ on $V(G)$ such that if an edge vu belong to $E(G)$, then $\sigma(v)\sigma(u)$ does not belong to $E(G)$.

Graph packing is well known field of graph theory that has been considerably investigated in the literature. The reader can find a good survey on packing of graphs in [1] and [2]. In particular, the question of the existence of 2-packing of a given graph has received a great attention. In [3], a full characterization of all the 2-packable $(n, n - 1)$ -graphs is given. Note that stars are the only connected $(n, n - 1)$ -graphs that are not 2-packable. A similar result about 2-packable (n, n) -graphs can be found in [4]. Other papers about packing of different trees into K_n can be found in [5] and [6].

An example of such a result is the following theorem contained as a lemma in [7].

Theorem 1.1 *Let T be a non-star tree of order n with $n > 3$. Then there exists a 2- placement σ of T such that for every $x \in V(T)$, $dist_T(x, \sigma(x)) \leq 3$.*

This theorem immediately implies the following:

Corollary 1.2 *Let T be a non-star tree of order n with $n > 3$. Then there exists an embedding σ of T such that $\sigma(T) \subset T^7$.*

In [6], Kheddouci et al. considered the problem of the 2-placement of a tree T into T^p such that p is as small as possible. They proved the following result.

Theorem 1.3 *Let T be a non-star tree of order n , with $n > 3$. Then there exists a 2-placement σ of T such that $\sigma(T) \subset T^4$.*

And in [8], Kaneko et al. proved that:

Theorem 1.4 *Let T be a non-star tree of order n , with $n > 3$. Then there exists a 2-placement σ of T such that $\sigma(T) \subset T^3$.*

The main result of this paper is:

Theorem 1.5 *Let G be an unstable graph. Then there exists a 2-placement σ of G such that $\sigma(G) \subset G^5$.*

Our paper is organised as follows: First, we give a characterisation of the unstable graph which is deduced from the results given by A. Ehrenfeucht, T. Harju and G. Rozenberg in [9]. Second, we prove Theorem 1.5.

2 Characterisation of the unstable graphs

We shall need some additional definitions and notations in order to formulate the results of this section.

Given a connected graph G . A vertex x of degree one, $d_G(x) = 1$, is called a leaf of G . The set of leaves of G is denoted by

$$Leaf(G) = \{x \in V, x \text{ is a leaf}\}.$$

If x is a leaf, then the unique edge e incident with x is called pendant edge. An edge e is a bridge if $G - e$ is disconnected graph, otherwise, e is a non-bridge. A bridge is said to be proper if is not a pendant edge. A vertex x is an island if it is incident with bridges only.

We denote by:

$$Nob(G) = \{e \in E, e \text{ is not a bridge}\}$$

$$Isl(G) = \{x \in V, x \text{ is an island}\}$$

$$\text{For } X \subseteq V, N_G(X) = \bigcup_{x \in X} N_G(x) \setminus X$$

Let G be an indecomposable graph. We say that $x \in V(G)$ is an *inside vertex*, if there exists a non-bridge $e = xy \in Nob(G)$ such that $x \in X$ for a nontrivial module X of $G - e$. On the other hand, if there exists a non-bridge $e = xy \in Nob(G)$ such that $x \notin X$ for a nontrivial module X of G , then x is called an *outside vertex*. We denote by

$$Out(G) = \{x \in V; x \text{ is an outside vertex}\} \text{ and } Ins(G) = \{x \in V; x \text{ is an inside vertex}\}$$

the set of outside and inside vertices of G .

The following results are given in [9]

Lemma 2.1 *Let G be an indecomposable graph. Then no inside vertex is incident with a bridge.*

A graph G is *triangle-free* if for each 3-subset $X = \{x_1, x_2, x_3\}$ of $V(G)$ there exists an edge $x_i x_j \notin E(G)$.

Lemma 2.2 *Let G be a connected and triangle-free graph, and let X be a nontrivial module of G . If a vertex $x \in X$ is incident with a bridge $e = xy$, then x is a leaf, and $X \subseteq Leaf(G)$.*

Theorem 2.3 *An unstable graph is triangle-free.*

Corollary 2.4 *Let G be an unstable graph. Then inside and outside vertices, and the islands forms a partition of $V(G)$:*

$$V = Out(G) \cup Ins(G) \cup Isl(G);$$

$$Out(G) \cap Ins(G) = Out(G) \cap Isl(G) = Ins(G) \cap Isl(G) = \emptyset.$$

Lemma 2.5 *Let G be an unstable graph, and $e \in Nob(G)$. Then $G - e$ has a unique module of two vertices and this module is discrete.*

Theorem 2.6 *Let G be an unstable graph. Then every inside vertex of G is adjacent to outside vertices only.*

Theorem 2.7 *Let G be an unstable graph and $e \in Nob(G)$. Let M_e be a non trivial module of $G - e$. Then $M_e \subseteq Ins(G) \cup Leaf(G)$.*

Corollary 2.8 *Let G be an unstable graph. Each outside vertex is adjacent to a leaf.*

Let us call a subgraph H a *pendant component* of a graph G if H is a connected component of a graph G' , which is obtained by removing from G all its proper bridges. If G is its pendant component, then it is called a pendant graph. In this case, G has no proper bridges.

Lemma 2.9 *For a pendant component H of a connected graph G ,*

1. H has no proper bridge;
2. for an edge $e \in E(H)$, e is a pendant edge of H if and only if e is a pendant edge of G ;
3. either H is a star or H contains a cycle;
4. $Leaf(H) \subseteq Leaf(G)$.

Definition 1 We call a B_{IO} – graph a bipartite indecomposable graph G of order $n \geq 5$, with a bipartition $\{I, O\}$ such that for all $y \in I$ and for all k – subset X_k of $N_G(y)$, $1 \leq k \leq d_G(y) - 1$, there exists a vertex $v_k \in I \setminus \{y\}$ such that $N_G(v_k) = X_k$

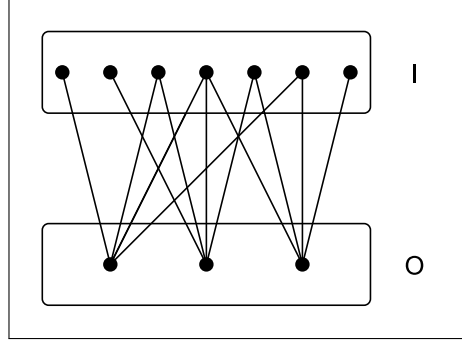

Fig. 1: A B_{IO} – graph with 10 vertices.

Lemma 2.10 Let G be a B_{IO} – graph. Then G is unstable.

Proof. Let G be a B_{IO} – graph and let $e = xy$ be an edge of $E(G)$. Note that if a graph G is indecomposable then G is connected since every nontrivial connected component is a nontrivial module of G . It follows that $G - e$ is decomposable when e is a bridge. Now, assume that $e = xy \in Nob(G)$ is a non-bridge of G such that $x \in O$ and $y \in I$. We denote $d_G(y) = n$. Clearly, y is not a leaf of G and then $n \geq 2$. Let $N_G(y) = \{x = x_1, x_2, \dots, x_n\}$ be the neighbors of y in G . By Definition 1, there exists a vertex $v \in I$ such that $N_G(v) = \{x_2, \dots, x_n\}$. Hence, $\{y, v\}$ is a nontrivial module of $G - e$. It follows that G is unstable. \square

Lemma 2.11 Let G be a B_{IO} – graph and $e = xy \in E(G)$ be a no proper bridge, such that $x \in O$ and $y \in I$. Then, $x \in Out(G)$ and either $y \in Leaf(G)$ or $y \in Ins(G)$.

Proof. By Corollary 2.4, $x, y \in Ins(G) \cup Out(G) \cup Isl(G)$. Since $e = xy$ is a no proper bridge, then $x, y \in Ins(G) \cup Out(G) \cup Leaf(G)$. Suppose, now, that $x \in Leaf(G)$. It follows that y is the unique neighbor of x in G . Since G is connected (Indecomposable), then there exists a vertex $z \neq x \in O$ such that $z \in N_G(y)$. By Definition 1, there exists a vertex $v \neq y \in I$ such that $v \in N_G(x)$, which contradict the fact that x is a leaf. It follows that $x \in Ins(G) \cup Out(G)$. On the other hand, let M_{xy} be the nontrivial module of $G - xy$. By Definition 1 and Lemma 2.5, there exists a vertex $v \in I$ such that $M_{xy} = \{y, v\}$. By Theorem 2.7, $y \in Ins(G) \cup Leaf(G)$ and $x \in Out(G)$. \square

Lemma 2.12 Let G be a pendant graph. If G is unstable, then G is a B_{IO} – graph.

Proof. Let G be a pendant graph, then G has no proper bridges. First, we prove that G is a bipartite graph. By Theorem 2.6, each cycle of G is of even length, and this is equivalent to say that G is bipartite. Second, let $\{I, O\}$ be the bipartition of G and $y \in I$, with $d_G(y) = n$. To conclude, we proceed by induction on the degree of y to prove that for all k – subset X_k of $N_G(y)$, $1 \leq k \leq n - 1$, there exists a vertex $v_k \in I \setminus \{y\}$ such that $N_G(v_k) = X_k$. If $n = 1$, no thing to prove. Assume that $n \geq 2$ and for all $1 \leq i \leq n - 1$ there exists a subsets of vertices $X_i \subset N_G(y)$ and a vertices $v_i \in I$ such that $N_G(v_i) = X_i$. Now, consider $e = xy \in E(G)$ and assume that $d_G(y) = n + 1$. Since G is unstable and $e \in Nob(G)$, then by Lemma 2.5, there exists a vertex $v \in I$ such that $M_e = \{y, v\}$ is the unique nontrivial module of $G - e$. Hence $d_{G-e}(y) = n$, then $d_G(v) = n$. By hypothesis, for all $1 \leq i \leq n - 1$ there exists a subsets of vertices $X_i \subset N_G(v)$ and a vertices $v_i \in I$ such that $N_G(v_i) = X_i$. Then, for all $1 \leq i \leq n$ there exists a subsets of vertices $X_i \subset N_G(y)$ and a vertices $v_i \in I$ such that $N_G(v_i) = X_i$. Consequently, G is a B_{IO} – graph. \square

Theorem 2.13 Let G be an indecomposable graph. Then G is unstable if and only if each pendant component of G with at least two vertices is either a B_{IO} – graph or an edge.

Proof. Let G be an indecomposable graph. Assume that each pendant component H_i , $i \geq 1$, of G is either a B_{IO} -graph or an edge. We prove that G is an unstable graph.

Let $e \in E(G)$. If $e \notin E(H_i)$, $i \geq 1$, then e is a proper bridge. Therefore, $G - e$ is disconnected, and thus, $G - e$ is decomposable. Otherwise, there exists $i \geq 1$ such that $e \in E(H_i)$. First, assume that H_i is an edge ($E(H_i) = \{e\}$). We will show that e is a pendant edge of G . Since e is not a proper bridge of G (by definition of the pendant components), then either e is a pendant edge of G or $e \in \text{Nob}(G)$. To the contrary, suppose that $e \in \text{Nob}(G)$. It follows that e is contained in a cycle C of G . Consider e' an adjacent edge to e in C . Clearly, e' is a non-bridge of G (since $e' \in C$): which contradicts the fact that $e' \notin E(H_i)$. Consequently, e is a pendant edge of G and hence $G - e$ is disconnected which implies that $G - e$ is decomposable. Second, assume that H_i is a B_{IO} -graph. In this case, by Lemma 2.10, H_i is unstable. Let M_e be the nontrivial module of $H_i - e$. By Theorem 2.7, $M_e \subset \text{Ins}(H_i) \cup \text{Leaf}(H_i)$. Recall that, by Lemma 2.1, no inside vertex is incident with a bridge. Moreover, by Lemma 2.9, $\text{Leaf}(H_i) \subseteq \text{Leaf}(G)$. Consequently, M_e is a nontrivial module of $G - e$, and hence G is unstable.

Conversely, consider an unstable graph G . If G is a pendant graph, then the result is obtained by Lemma 2.12. Hence we may assume that G has at least two pendant components. Let H_i be a pendant component of G . First, assume that $|V(H_i)| \leq 4$. Since H_i has no proper bridges and G is triangle free by Theorem 2.3, then either $H_i \simeq C_4$ or $H_i \simeq S_p$, with $2 \leq p \leq 4$. Suppose that $H_i \simeq C_4$ and let $V(H_i) = \{x_1, x_2, x_3, x_4\}$ and $E(H_i) = \{x_1x_2, x_2x_3, x_3x_4, x_4x_1\}$. By Corollary 2.4, $V(H_i) \subset \text{Out}(G) \cup \text{Ins}(G)$. Then, by Theorem 2.6, there exists two vertices, say x_1, x_3 , in $\text{Ins}(G)$. Since $\{x_1, x_3\}$ is a module of H_i , then $\{x_1, x_3\}$ is a nontrivial module of G , by Lemma 2.1. Which contradicts the fact that G is indecomposable. Hence, we may assume that $H_i \simeq S_p$, with $2 \leq p \leq 4$. By Lemma 2.9, we have $\text{Leaf}(H_i) \subseteq \text{Leaf}(G)$, then $p = 2$. Otherwise, $G[\text{Leaf}(H_i)]$ is a nontrivial module of G , which contradicts the fact that G is indecomposable. Consequently, H_i is an edge. Second, assume that $|V(H_i)| \geq 5$. In this case, we will show that H_i is a B_{IO} -graph. Using Lemma 2.12, it suffices to prove that H_i is unstable (since H_i is a pendant component of G). In a first step, we shall prove that H_i is indecomposable. To the contrary, suppose that H_i has a nontrivial module X . Since H_i is triangle free and connected, $G[X]$ is discrete. Moreover, X is not a module of G (since G is indecomposable). Therefore, there exists a proper bridge $e = xy$ for some $x \in X$ and $y \notin V(H_i)$. By Lemma 2.1 and Corollary 2.4, x is either an island or an outside vertex of G . Clearly, if $x \in \text{Isl}(G)$, then $x \in \text{Isl}(H_i)$, and from Lemma 2.2 we obtain that $X \subseteq \text{Leaf}(H_i)$. Further more, by Lemma 2.9, we have $\text{Leaf}(H_i) \subseteq \text{Leaf}(G)$, which contradict the fact that $e = xy$ is a proper bridge. It ensues that $x \in \text{Out}(G)$. By Corollary 2.8, x is adjacent to a leaf $v \in \text{Leaf}(G)$. Since xv is not a proper bridge, then $v \in \text{Leaf}(H_i)$. By Lemma 2.2, we have x is a leaf of H_i , which is a contradiction. Consequently, H_i is indecomposable. In a second step, we will show that H_i has no removable edge. Consider an edge $e = xy$ of H_i . By definition of the pendant components, either e is a pendant edge or a non-bridge of G . In the first case, one can obviously observe that $H_i - e$ is disconnected and then decomposable. In the second case, since G is unstable, by Lemma 2.5 it follows that $G - e$ has a unique discrete module of two vertices M_e , say $M_e = \{y, z\}$. Now it remains to prove that M_e is a module of $H_i - e$. The vertex $y \in M_e$ is an inside vertex of G , and thus, by Lemma 2.1, it is not incident with a bridge of G . Then $N_G(y) \subseteq V(H_i)$. Since M_e is a module of $G - e$, we have $N_G(z) = N_G(y) \setminus \{x\}$, and thus $N_G(M_e) \subseteq V(H_i)$. By Theorem 2.7, $z \in \text{Ins}(G) \cup \text{Leaf}(G)$, then $z \in V(H_i)$. Consequently, M_e is a module of $H_i - e$ and hence H_i is unstable. \square

3 Packing of an unstable graph into its fifth power

In order to formulate the results of this section, we shall need some additional definitions and notations.

Consider an unstable graph G . We denote by C_1, C_2, \dots, C_r , $r \geq 1$, the pendant components of G such that $|C_i| \geq 5$.

Given an integer $j \in \{1, \dots, r\}$, we define a partition $\mathcal{P} = \{X_1, X_2, \dots, X_p\}$ on the vertex set of $\text{Out}(C_j)$, such that:

1. for all $i \in \{1, \dots, p\}$, $|X_i| \in \{2, 3\}$,
2. if $|X_i| = 2$ there exists a vertex $y \in \text{Ins}(C_j)$ such that $X_i \subseteq N_{C_j}(y)$,
3. if $|X_i| = 3$ there exist two vertices $y, z \in \text{Ins}(G)$ such that $X_i \subseteq N_{C_j}(y) \cup N_{C_j}(z)$ (See Figure. 2).

Let $x \in C_j$, $1 \leq j \leq r$. We say that x is a *representative vertex* of G if x is incident with a proper bridge. We denote by

$$R(G) = \{x \in V(G), x \text{ is a representative vertex}\}$$

Note that $R(G) \subseteq \text{Out}(G)$.

Let $V' = R(G) \cup \text{Isl}(G)$. The graph $G' = G[V']$ is called the *representative graph* of G .

Remark 1 Let G' be the representative graph of an unstable graph G .

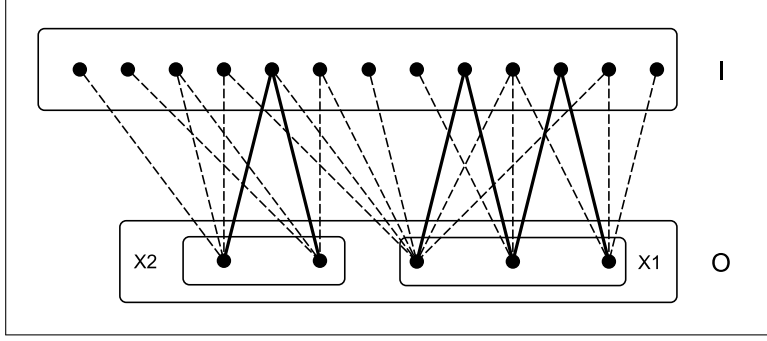

Fig. 2: An example of a partition $\mathcal{P}(O)$.

1. Each connected component of G' is a tree.
2. Let T_1, T_2, \dots, T_q , $q \geq 1$, be the connected components of G' . Then for all $i \in \{1, 2, \dots, r\}$ and $j \in \{1, 2, \dots, q\}$, $|C_i \cap T_j| \leq 1$.

Lemma 3.1 Let G be a pendant graph of order $n \geq 5$. If G is unstable, then there exists a 2 – placement σ_C on $V(G)$ such that $\sigma_C(G) \subseteq G^5$.

Proof. If G is unstable then, by Lemma 2.12, G is a B_{IO} – graph. Firstly, according to the cardinality of $|X_i| = 2$ or 3, $i \in \{1, \dots, p\}$, we will define σ_C on $Out(G) \cup Leaf(G)$ as follows. If there exists $i \in \{1, \dots, p\}$ such that $|X_i| = 2$. Say that, for instance, $X_i = \{x_i, y_i\}$ and consider $u_i, v_i \in Leaf(G)$ the respectively neighbors leaves of x_i, y_i in G . Then, σ_C is defined on $\{x_i, u_i, y_i, v_i\}$ by the cycle $(x_i u_i y_i v_i)$ (see Figure 3 (a)). Now, if there exists $i \in \{1, \dots, p\}$ such that $|X_i| = 3$. say that, for instance, $X_i = \{x_i, y_i, z_i\}$ and consider $u_i, v_i, w_i \in Leaf(G)$ the respectively neighbors leaves of x_i, y_i, z_i in G . In this case, σ_C is defined on $\{x_i, u_i, y_i, v_i, z_i, w_i\}$ by the cycle $(x_i u_i y_i v_i z_i w_i)$ (see Figure 3 (b)). Finally, for any vertex $x \in Ins(G)$ we take $\sigma_C(x) = x$.

In order to achieve our target, we will show that σ_C is a 2 – placement on $V(G)$ such that $\sigma_C(G) \subseteq G^5$. Given $e = xy \in E(G)$. One can obviously observe that either $e \in Out(G) \times Ins(G)$ or $e \in Out(G) \times Leaf(G)$, since G is a pendant graph. In the first case, $\sigma_C(xy) = \sigma_C(x)y$ with $\sigma_C(x) \in N_G(x) \cap Leaf(G)$. Thus, $\sigma_C(x)y \notin E(G)$ and $dist_G(\sigma_C(x), y) = 2$. In the second case, $\sigma_C(xy) = \sigma_C(x)\sigma_C(y)$ with $\sigma_C(x) \in N_G(x) \cap Leaf(G)$ and $\sigma_C(y) \in X_i \setminus \{x\}$. It ensues that $\sigma_C(x)\sigma_C(y) \notin E(G)$ and $dist_G(\sigma_C(x), \sigma_C(y)) \leq 5$ (see Figure. 3). \square

Remark 2 Given an unstable graph G . Consider C_1, C_2, \dots, C_r , $r \geq 1$, the pendant components of G such that $|C_i| \geq 5$. In the remainder of this paper, we denote by σ_{C_i} the permutation defined in the previous proof on $V(C_i)$, $1 \leq i \leq r$.

In the Lemmas (3.2, 3.3 and 3.4) below, we will define a 2 – placement of the graph G when it's representative graph G' is connected.

Lemma 3.2 Given an unstable graph G of order $n \geq 5$, consider G' it's representative graph. If G' is an edge, then there exists a 2 – placement σ_{S_2} on $V(G)$ such that $\sigma_{S_2}(G) \subseteq G^5$.

Proof. Given an unstable graph G of order $n \geq 5$. We consider G' the representative graph of G such that G' is an edge $e = x_1x_2$. First, we will show that $x_1, x_2 \in R(G)$. To the contrary, suppose for instance that $x_2 \notin R(G)$. Clearly, $x_2 \in Leaf(G)$. Let C_1 be the pendant component of G such that $x_1 \in C_1$. By Theorem 2.13, C_1 is unstable, and then there exists a vertex $v \neq x_2 \in Leaf(G)$ such that $x_1v \in E(G)$. It follows that $\{x_2, v\}$ is a nontrivial module of G , which contradicts the fact that G is an indecomposable graph.

Second, we will define a 2 – placement σ_{S_2} on $V(G)$ as follows. Consider C_1, C_2 the two pendant components of G such that $|C_i| \geq 5$, $i = 1, 2$. By Theorem 2.13, C_i is an unstable graph, $i = 1, 2$. Hence, by Lemma 3.1 there exists a 2 – placement σ_{C_i} on $V(C_i)$ such that $\sigma_{C_i}(C_i) \subseteq C_i^5$, $i = 1, 2$. We shall discuss the following cases.

Case.1: If $|X| = |Y| = 3$, assume that $X = \{x_1, y_1, z_1\}$ and $Y = \{x_2, y_2, z_2\}$. Let u_i, v_i, w_i be the respective neighbors leaves of x_i, y_i, z_i , $i = 1, 2$. We consider the permutation σ_{S_2} defined on $V(G)$ by $(x_1u_1x_2u_2)(y_1v_1z_1w_1)$, $i = 1, 2$ and $\sigma_{S_2}(w) = \sigma_{C_i}(w)$, for $w \in V(C_i) \setminus \{x_i, y_i, z_i, u_i, v_i, w_i\}$, $i = 1, 2$. Now, consider $e = xy \in E(C_i)$. If $e \in Out(C_i) \times Ins(C_i)$, then $\sigma_{S_2}(xy) = vy$, with $xv \in E(G)$ then $dist_G(\sigma_{S_2}(x), \sigma_{S_2}(y)) = 2$. Else, either $e \in Out(C_i) \times Leaf(C_i)$ or $e = x_1x_2$. In the first case, $\sigma_{S_2}(xy) = vu$, with $xv \in E(G)$ and $u \in X_i$ and then

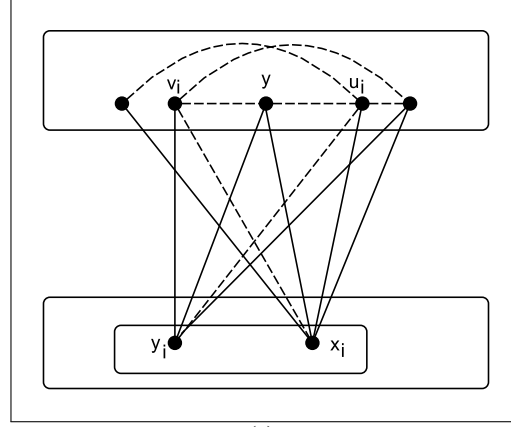

(a)

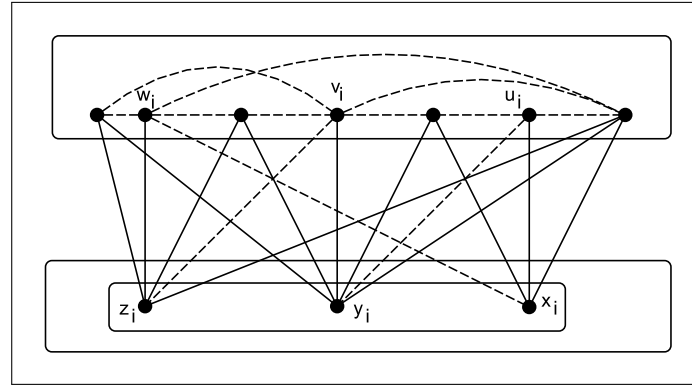

(b)

Fig. 3: Illustration of the proof of Lemma 3.1. The dots edges are in the second copy of G .

$dist_G(\sigma_{S_2}(x), \sigma_{S_2}(y)) \leq 5$. In the second one, $\sigma_{S_2}(e) = u_1 u_2$ and $dist_G(u_1, u_2) = 3$. Hence, σ_{S_2} is a permutation on $V(G)$ such that $\sigma_{S_2}(G) \subseteq G^5$.

Case.2: If $|X| = |Y| = 2$ or $|X| \neq |Y|$. In this case we consider the permutation σ_{S_2} defined on $V(G)$ by $\sigma_{S_2}(x) = \sigma_{C_i}(x)$ for $x \in V(G)$. It easily verified that $\sigma_{S_2}(G) \subseteq G^5$ (see Figure 4).

□

Lemma 3.3 Given an unstable graph G of order $n \geq 5$, consider G' its representative graph. If G' is a star S_p , $p \geq 3$, then there exists a 2-placement σ_{S_2} on $V(G)$ such that $\sigma_{S_2}(G) \subseteq G^5$.

Proof. Let $V(G') = \{x_1, x_2, \dots, x_p\}$ such that $d_{G'}(x_p) = p - 1$ (see Figure. 5). To begin, since G is an indecomposable graph, one can obviously observe that $|\{x_1, x_2, \dots, x_{p-1}\} \setminus R(G)| \leq 1$. Let C_1, C_2, \dots, C_r be the pendant components of G such that $x_i \in C_i$, $1 \leq i \leq r$. Let $X_i \in \mathcal{P}(Out(C_i))$ such that $x_i \in X_i$, $1 \leq i \leq r$. We denote by u_i the neighbor leaf of x_i on C_i . Let $T = G[V(G') \cup \{u_1\}]$. We consider the permutation σ_T defined on $V(T)$ by the cycle $(x_1 u_1 x_p x_2 \dots x_i x_{i+1} \dots x_{p-1})$, $2 \leq i \leq p - 2$. It easily verified that $\sigma_T(T) \subseteq T^3$.

Now, according to the cardinality of X_i , we define a permutation σ_{S_p} on $V(G)$ as follows:

Case.1: If $|X_i| = 3$, say for instance that $X_i = \{x_i, y_i, z_i\}$. We denote by u_i, v_i, w_i the respective neighbors leaves of x_i, y_i, z_i . Our permutation σ_{S_p} is defined on $V(G)$ by $\sigma_{S_p}(y_i) = v_i$, $\sigma_{S_p}(z_i) = w_i$, $\sigma_{S_p}(v_i) = z_i$, $\sigma_{S_p}(w_i) = y_i$, and for all other vertex $x \in V(G)$

$$\sigma_{S_p}(x) = \begin{cases} \sigma_T(x), & \text{if } x \in V(T) \\ \sigma_{C_i}(x), & \text{if } x \in V(C_i). \end{cases}$$

Case.2: If $|X_i| = 2$, say for example that $X_i = \{x_i, y_i\}$. We denote by u_i, v_i the respective neighbors leaves of x_i, y_i . Our permutation σ_{S_p} is defined on $V(C_i) \setminus \{x_i\}$ by $\sigma_{S_p}(y_i) = x_p$, $\sigma_{S_p}(u_1) = y_1$, $\sigma_{S_p}(y_i) = u_i$ and $\sigma_{S_p}(u_i) = y_i$ for

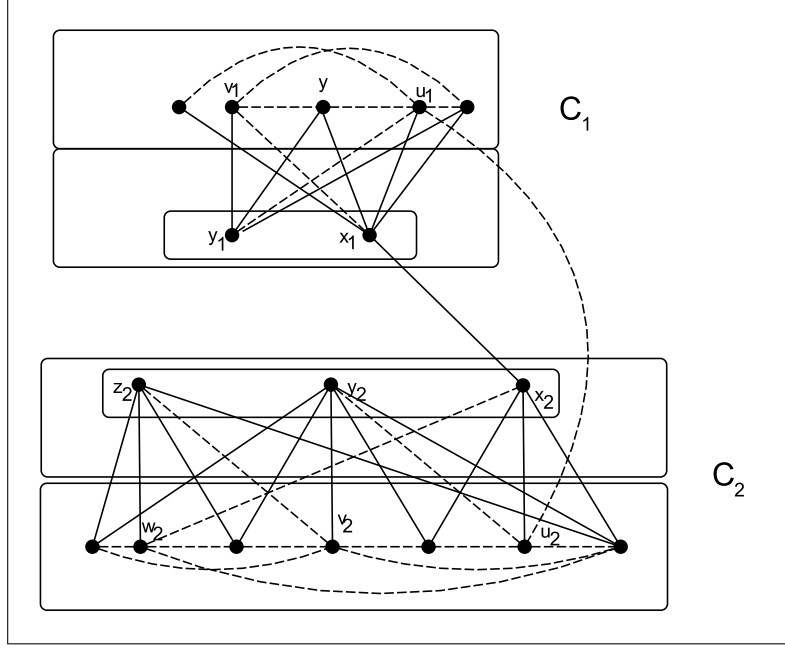

Fig. 4: Illustration of Lemma 3.2. The dots edges are in the second copy of G .

$i = 2, \dots, r$, $\sigma_{S_p}(v_i) = v_i$ for $i = 1, \dots, r$, and for all other vertex $x \in V(G)$

$$\sigma_{S_p}(x) = \begin{cases} \sigma_T(x), & \text{if } x \in V(T) \\ \sigma_{C_i}(x), & \text{if } x \in V(C_i). \end{cases}$$

It remains to show that σ_{S_p} is a 2-*placement* on $V(G)$ such that $\sigma_{S_p}(G) \subseteq G^5$. Consider an edge $e = xy \in E(G)$. First, if $e \in \text{Out}(C_i) \times \text{Ins}(C_i)$ then $\sigma_{S_p}(xy) = vy$, such that $v \notin \text{Out}(G)$ and $\text{dist}_G(x, v) = 1, 2$. Then $\sigma_{S_p}(e) \notin E(G)$ and $\text{dist}_G(\sigma_{S_p}(x), \sigma_{S_p}(y)) \leq 3$. Second, if $e \in \text{Out}(C_i) \times \text{Leaf}(C_i)$. Then, either $\sigma_{S_p}(xy) = vu$, with $xv \in E(G)$ and $u \in X_i$, or $\sigma_{S_p}(e) \in \{u_1x_p, x_{i+1}u_i, x_1u_{p-1}, x_pv_1, x_i + 1y_i\}$. In the two cases $\text{dist}_G(\sigma_C(x), \sigma_C(y)) \leq 5$. Finally, if $e \in E(T)$ then $\sigma_{S_p}(e) \in E(T^3) \setminus E(T)$. Hence σ_{S_p} is a 2-*placement* on $V(G)$ such that $\sigma_{S_p}(G) \subseteq G^5$. \square

Remark 3 In the remainder of this paper, we denote by σ_{S_p} , $p \geq 2$, the permutation defined on $V(G)$ in the previous proofs of Lemmas 3.2 and 3.3.

Lemma 3.4 Given an unstable graph G . consider G' its representative graph. If G' is a tree U such that $\text{Diam}(U) \geq 3$, then there exists a 2-*placement* σ_U on $V(G)$ such that $\sigma_U(G) \subseteq G^5$.

Proof. Assume that $R(G) = \{x_1, x_2, \dots, x_p\}$, and let C_1, C_2, \dots, C_p , be the pendant components of G such that $x_i \in C_i$, $1 \leq i \leq p$. By Theorem 1.4, there exists a 2-*placement* of U into U^3 . In the sequel, such a 2-*placement* of U will be denoted by σ . We define our permutation σ_U on $V(G)$ as follows: Given a vertex $x \in V(G)$, if $x \notin V(C_i)$ for $1 \leq i \leq p$, thus $x \in V(U) \setminus R(G)$. Then, $\sigma_U(x) = \sigma(x)$. Else there exists $i \in \{1, \dots, p\}$ such that $x \in V(C_i)$. Let $X_i \in \mathcal{P}(\text{Out}(C_i))$ such that $x_i \in X_i$. First, if $\sigma(x_i) = x_i$ it suffices to put $\sigma_U(x) = \sigma_{C_i}(x)$ for $x \in V(C_i)$. Second, if $\sigma(x_i) \neq x_i$, then according to the cardinality of X_i , we will distinguish the following cases.

Case.1: If $|X_i| = 3$, say, for instance, that $X_i = \{x_i, y_i, z_i\}$. We denote by u_i, v_i, w_i the respective neighbors leaves of x_i, y_i, z_i . We consider the permutation σ_U defined on $V(C_i)$ by $(y_i v_i z_i w_i)(u_i)$, $\sigma_U(x_i) = \sigma(x_i)$, and $\sigma_U(x) = \sigma_{C_i}(x)$ for $x \in V(C_i) \setminus (X_i \cup \{u_i, v_i, w_i\})$.

Case.2: If $|X_i| = 2$, say, for instance, that $X_i = \{x_i, y_i\}$. We denote by u_i, v_i the respective neighbors leaves of x_i, y_i . Let σ_U be a permutation defined on $V(C_i)$ by $(y_i u_i)(v_i)$, $\sigma_U(x_i) = \sigma(x_i)$, and for all $x \in V(C_i) \setminus (X_i \cup \{u_i, v_i\})$, $\sigma_U(x) = \sigma_{C_i}(x)$.

Now, it remains prove that σ_U is a 2-*placement* on $V(G)$ such that $\sigma_U(G) \subseteq G^5$. Consider $e = xy \in E(G)$. First, assume that $x, y \notin R(G)$. In this case, $\sigma_U(e) \in \{\sigma_{C_i}(e), \sigma(e), v_i z_i, w_i y_i, u_i v_i\}$. It follows that $\sigma_U(e) \notin E(G)$ and $\text{dist}_G(\sigma_U(x), \sigma_U(y)) \leq 5$. Second, assume that $x, y \in R(G)$. In this case, $x \in \text{Out}(C_i)$ and $y \in \text{Out}(C_j)$,

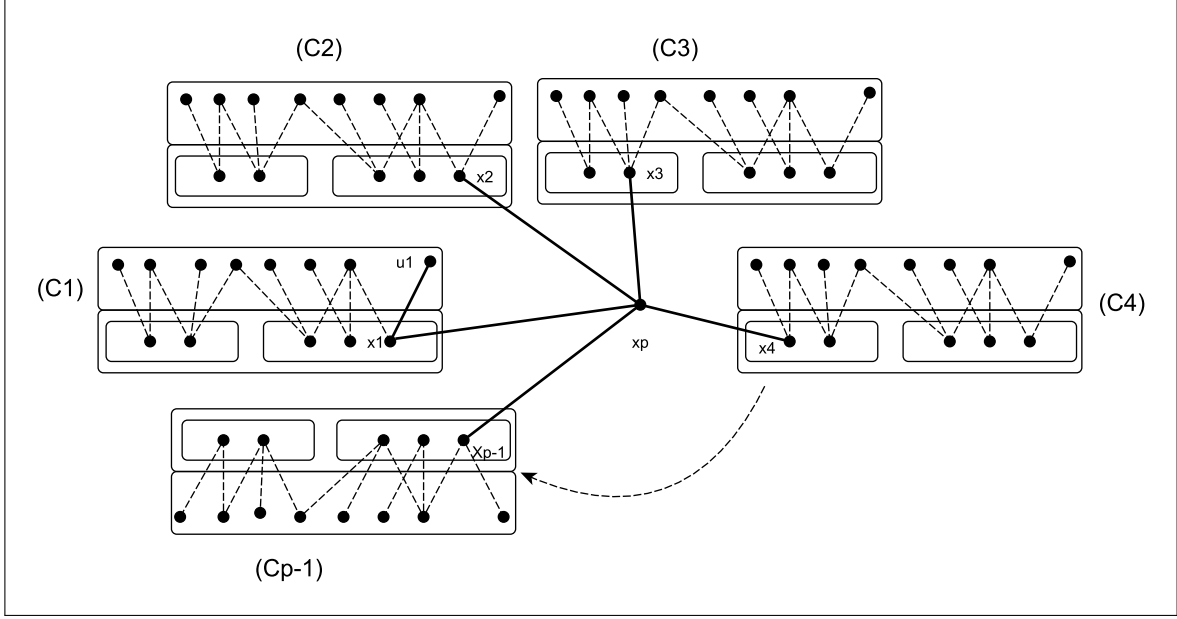

Fig. 5: An example when G' is a star.

with $i \neq j$. Thus, $\sigma_U(e) \in \{\sigma(xy), \sigma(x)\sigma_{C_j}(y), \sigma_{C_i}(x)\sigma(y), \sigma_{C_i}(x)\sigma_{C_j}(y)\}$. Hence, $\sigma_U(e) \notin E(G)$. Moreover, since $\text{dist}_G(x, \sigma(x)) \leq 3$ and $\text{dist}_G(x, \sigma_{C_i}(x)) = 1$, one can obviously observe that $\text{dist}_G(\sigma_U(x), \sigma_U(y)) \leq 5$. Finally, and without loss of generalities, we can assume that $x \in R(G)$ and $y \notin R(G)$. In this case, $\sigma_U(e) \in \{\sigma_{C_i}(e), \sigma(e), \sigma(x)y, \sigma_{C_i}(x)\sigma(y), \sigma(x)u_i\}$. It ensues that $\sigma_U(e) \notin E(G)$. Furthermore, since $\text{dist}_G(x, \sigma(x)) \leq 3$ and $\text{dist}_G(x, \sigma_{C_i}(x)) = 1$, it follows that $\text{dist}_G(\sigma_U(x), \sigma_U(y)) \leq 5$. Consequently, σ_U is a 2-placement on $V(G)$ such that $\sigma_U(G) \subseteq G^5$. \square

Proof of Theorem 1.5.

Given an unstable graph G of order $n \geq 4$, consider $C_1, C_2, \dots, C_r, r \geq 1$, the family of its pendant components such that $|C_i| \geq 5, 1 \leq i \leq r$.

Claim 1 *If each pendant component of G is either a singleton or an edge, then there exists a 2-placement σ such that $\sigma(G) \subseteq G^3$.*

Indeed: In this case, the graph G is without cycles. Consequently, G is a tree. Moreover, since G is an indecomposable graph, then G is a non-star tree. By Theorem 1.4, there exists a 2-placement σ such that $\sigma(G) \subseteq G^3$.

Claim 2 *If G is a pendant graph, then there exists a 2-placement σ such that $\sigma(G) \subseteq G^5$.*

Indeed: By Lemma 3.1, there exists a 2-placement σ such that $\sigma(G) \subseteq G^5$.

From now on, we shall assume that we can apply neither Claim 1 nor Claim 2 to the graph G . Under this assumption, we will define a 2-placement σ on $V(G)$ such that $\sigma(G) \subseteq G^5$. Let $C_i, 1 \leq i \leq r$, be a pendant component of G and $X_i \in \mathcal{P}(\text{Out}(C_i))$. We shall discuss the followings two cases.

Case.1: If $|X_i| = 2$, say for instance that $X_i = \{x_i, y_i\}$ and we denote by u_i, v_i the respective neighbors leaves of x_i, y_i . First, we assume that $|X_i \cap R(G)| = 0$. In this case the permutation σ is defined on $\{x_i, y_i, u_i, v_i\}$ by $\sigma(x) = \sigma_{C_i}(x)$. Second, assume that $|X_i \cap R(G)| = 1$. Without loss of generality, we can suppose that $x_i \in R(G)$. Let T be a connected component of G' such that $x_i \in V(T)$. In this case it suffices to consider the permutation σ defined on $\{x_i, y_i, u_i, v_i\}$ by $\sigma(x) = \sigma_{S_p}(x), p \geq 2$, if $T \simeq S_p$ (i.e T is isomorphic to S_p) with σ_{S_p} is that given by Lemma 3.2 and Lemma 3.3 and $\sigma(x) = \sigma_U(x)$, if $\text{Diam}(T) \geq 3$ with σ_U is that given by Lemma 3.4. Finally, assume that $|X_i \cap R(G)| = 2$. Let T, T' be the connected components of G' such that $x_i \in V(T)$ and $y_i \in V(T')$.

Subcase.1.1: If $T \simeq S_p$ and $T' \simeq S_{p'}$ with $p, p' \geq 2$. We define a permutation σ on $\{x_i, y_i, u_i, v_i\}$ by $\sigma(x) = \sigma_{S_p}(x)$ if $x \in \{x_i, u_i\}$ and $\sigma(x) = \sigma_{S_{p'}}(x)$ if $x \in \{y_i, v_i\}$, with σ_{S_p} and $\sigma_{S_{p'}}$ are those given by Lemma 3.2 and Lemma 3.3.

Subcase.1.2: If $T \simeq S_p$, $p \geq 2$, and $Diam(T') \geq 3$. By Theorem 1.4, there exists a permutation $\sigma_{T'}$ defined on $V(T')$ such that $\sigma_{T'}(T') \subseteq T'^3$. We define a permutation σ on $\{x_i, y_i, u_i, v_i\}$ as follows. First, if $\sigma_{T'}(y_i) \neq y_i$, then $\sigma(x) = \sigma_{S_p}(x)$ if $x \in \{x_i, u_i\}$, $\sigma(y_i) = \sigma_{T'}(y_i)$ and $\sigma(v_i) = v_i$, with σ_{S_p} is the permutation given by Lemma 3.2 and Lemma 3.3. Second, if $\sigma_{T'}(y_i) = y_i$, then $\sigma(x) = \sigma_{S_p}(x)$, with σ_{S_p} is the permutation given by Lemma 3.2 and Lemma 3.3.

Subcase.1.3: If $Diam(T) \geq 3$ and $Diam(T') \geq 3$. By Theorem 1.4, there exist permutations $\sigma_T, \sigma_{T'}$ defined respectively on $V(T)$ and $V(T')$ such that $\sigma_T(T) \subseteq T^3$ and $\sigma_{T'}(T') \subseteq T'^3$. We define a permutation σ on $\{x_i, y_i, u_i, v_i\}$ as follows. First, if $\sigma_T(x_i) = x_i$ and $\sigma_{T'}(y_i) = y_i$, then $\sigma(x) = \sigma_{C_i}(x)$. Second if $\sigma_T(x_i) = x_i$ and $\sigma_{T'}(y_i) \neq y_i$ (or $\sigma_T(x_i) \neq x_i$ and $\sigma_{T'}(y_i) = y_i$), then $\sigma(x) = \sigma_U(x)$ with σ_U is that given by Lemma 3.4. Finally, if $\sigma_T(x_i) \neq x_i$ and $\sigma_{T'}(y_i) \neq y_i$, then $\sigma(x_i) = \sigma_T(x_i)$, $\sigma(u_i) = u_i$, $\sigma(y_i) = \sigma_{T'}(y_i)$ and $\sigma(v_i) = v_i$.

Case.2: If $|X_i| = 3$, assume that $X_i = \{x_i, y_i, z_i\}$ and denote by u_i, v_i, w_i the respective neighbors leaves of x_i, y_i, z_i . First, assume that $|X_i \cap R(G)| = 0$. In this case, the permutation σ is defined on $X_i \cup \{u_i, v_i, w_i\}$ by $\sigma(x) = \sigma_{C_i}(x)$. Second, suppose that $|X_i \cap R(G)| = 1$. Then, either $\sigma(x) = \sigma_{S_p}(x)$ with σ_{S_p} is that given by Lemma 3.2 and Lemma 3.3, or $\sigma(x) = \sigma_U(x)$ with σ_U is that given by Lemma 3.4. Third, if $|X_i \cap R(G)| = 2$. Without loss of generalities, one can assume that $x_i, y_i \in R(G)$. Let T, T' be the connected components of the representative graph G' such that $x_i \in V(T)$ and $y_i \in V(T')$. In this case, if one of the trees T or T' , say T , is isomorphic to S_p , $p \geq 2$, then it suffices to put $\sigma(x) = \sigma_{S_p}(x)$ for $x \in \{x_i, u_i\}$ and identify σ with the permutations σ_{S_p}, σ_U defined by Lemmas 3.2, 3.3, 3.4 (When $|X_i| = 2$), for $x \in \{y_i, z_i, v_i, w_i\}$. Otherwise, assume that $Diam(T) \geq 3$ and $Diam(T') \geq 3$. In this case, if $\sigma_T(x_i) = x_i$ and $\sigma_{T'}(y_i) = y_i$, then $\sigma(x) = \sigma_{C_i}(x)$ for $x \in X_i \cup \{u_i, v_i, w_i\}$. Else, assume for instance that $\sigma_T(x_i) \neq x_i$. Then, it suffices to take $\sigma(x_i) = \sigma_T(x_i)$, $\sigma(u_i) = u_i$ and identify σ with the permutation σ_U defined by Lemma 3.4 (Case. $|X_i| = 2$), for $x \in \{y_i, z_i, v_i, w_i\}$. Finally, assume that $|X_i \cap R(G)| = 3$. Let T, T' and T'' be the connected components of the representative graph G' such that $x_i \in V(T)$, $y_i \in V(T')$ and $z_i \in V(T'')$. In this case, if one of the trees T, T' or T'' , say for instance T , is isomorphic to S_p , $p \geq 2$, then it suffices to put $\sigma(x) = \sigma_{S_p}(x)$ for $x \in \{x_i, u_i\}$, and for $x \in \{y_i, z_i, v_i, w_i\}$ the permutation $\sigma(x)$ is that given by the previous case ($|X_i \cap R(G)| = 2$ applied to T' and T''). Otherwise, $Diam(T) \geq 3$, $Diam(T') \geq 3$ and $Diam(T'') \geq 3$. Let $\sigma_T, \sigma_{T'}$ and $\sigma_{T''}$ be the permutation defined by Theorem 1.4 respectively on $V(T), V(T')$ and $V(T'')$.

Subcase.2.1: Assume that $\sigma_T(x_i) = x_i$, $\sigma_{T'}(y_i) = y_i$ and $\sigma_{T''}(z_i) = z_i$. Then $\sigma(x) = \sigma_{C_i}(x)$ for $x \in X_i \cup \{u_i, v_i, w_i\}$.

Subcase.2.2: Assume that $\sigma_T(x_i) \neq x_i$, $\sigma_{T'}(y_i) \neq y_i$ and $\sigma_{T''}(z_i) \neq z_i$. Then, we define a permutation σ on $X_i \cup \{u_i, v_i, w_i\}$ by $\sigma(x_i) = \sigma_T(x_i)$, $\sigma(y_i) = \sigma_{T'}(y_i)$, $\sigma(z_i) = \sigma_{T''}(z_i)$ and $\sigma(x) = x$ for $x \in \{u_i, v_i, w_i\}$.

Subcase.2.3: Assume that $\sigma_T(x_i) \neq x_i$, $\sigma_{T'}(y_i) = y_i$. In this case, it suffices to put $\sigma(x_i) = \sigma_T(x_i)$, $\sigma(u_i) = u_i$ and for $x \in \{y_i, z_i, v_i, w_i\}$, $\sigma(x)$ is the permutation given by Lemma 3.4.

Now, for all other vertices $x \in V(G)$, either $x \in Ins(C_i)$, $1 \leq i \leq r$, or $x \in V \setminus \bigcup_{i=1}^r C_i$. Then, it suffices to put $\sigma(x) = x$ if $x \in Ins(C_i)$, $1 \leq i \leq r$; otherwise, if $x \in V \setminus \bigcup_{i=1}^r C_i$ then $x \in T$, with T is connected component of the representative graph G' . Hence, $\sigma(x) = \sigma_{S_p}(x)$ if $x \in S_p$, $p \geq 3$, and $\sigma(x) = \sigma_T(x)$ if $Diam(T) \geq 3$, with σ_T is the permutation given by Theorem 1.4.

To conclude, it remains to verify that our permutation σ is a 2-placement of G into G^5 . Given an edge $e = xy \in E(G)$, then either $e \in Nob(G)$ or not.

Case.1: If $e = xy \in Nob(G)$. Clearly, $e \in Out(G) \times Ins(G)$ (i.e $x \in Out(G)$ and $y \in Ins(G)$) and

$$\sigma(e) = \begin{cases} \sigma_{S_p}(e), & \text{if } x \in S_p \\ \sigma_T(e), & \text{if } x \in T \text{ and } \sigma_T(x) \neq x \text{ (with } Diam(T) \geq 3). \\ \sigma_{C_i}(e), & \text{if } x \notin R(G) \text{ or } x \in T \text{ and } \sigma_T(x) = x \text{ (with } Diam(T) \geq 3). \end{cases}$$

In all these cases, we have already checked that our permutation is a 2-placement of G into G^5 .

Case.2: If $e = xy \notin Nob(G)$. Clearly, e is either a pendant edge or e is a proper bridge of G .

Subcase.2.1: If $e = xy$ is a pendant edge of G . Say, for instance, that $y \in Leaf(G)$. In this case,

$$\sigma(e) = \begin{cases} \sigma_{S_p}(e), & \text{if } x \in S_p \\ \sigma_T(e), & \text{if } x \in T \setminus R(G) \text{ (with } Diam(T) \geq 3). \\ \sigma_T(x)y, & \text{if } x \in T \cap R(G) \text{ and } \sigma_T(x) \neq x \text{ (with } Diam(T) \geq 3). \\ \sigma_{C_i}(e), & \text{if } x \notin R(G) \text{ or } x \in T \cap R(G) \text{ and } \sigma_T(x) = x \text{ (with } Diam(T) \geq 3). \end{cases}$$

Here, it remains just to verify that $\sigma_T(x)y$ is an edge of $E(G^5) \setminus E(G)$. Clearly, $\sigma_T(x) \neq y$ since $y \notin T$. Moreover, $dist_G(x, \sigma_T(x)) \leq 3$ and $dist_G(x, y) = 1$. Therefore, $dist_G(\sigma_T(x), y) \leq 4$ and $\sigma_T(x)y \notin E(G)$. Which permits us to conclude.

Subcase.2.2: If $e = xy$ is a proper bridge of G . Clearly, at least one of the two vertices x, y is not a representative vertex of G , say for instance $y \notin R(G)$. In this case,

$$\sigma(e) = \begin{cases} \sigma_T(e), & \text{if } x \notin R(G) \text{ or } x \in R(G) \text{ and } \sigma_T(x) \neq x (\text{with } \text{Diam}(T) \geq 3) \\ \sigma_{C_i}(x)\sigma_T(y), & \text{if } x \in R(G) \text{ and } \sigma_T(x) = x (\text{with } \text{Diam}(T) \geq 3). \end{cases}$$

Here, it remains just to verify that $\sigma_{C_i}(x)\sigma_T(y)$ is an edge of $E(G^5) \setminus E(G)$. Clearly, $\text{dist}_G(x, \sigma_{C_i}(x)) = 1$ since $\sigma_{C_i}(x)$ is the neighbor leaf of x . Moreover, $\sigma_{C_i}(x) \neq y$ since xy is a proper bridge of G (i.e y is not a leaf of G). Furthermore, $\text{dist}_G(y, \sigma_T(y)) \leq 3$. Consequently, $\sigma_{C_i}(x)\sigma_T(y) \notin E(G)$ and $\text{dist}_G(\sigma_{C_i}(x), \sigma_T(y)) \leq 5$.

References

- [1] Mariusz Woźniak. Packing of graphs and permutations—a survey. *Discrete Mathematics*, 276(1):379–391, 2004.
- [2] HP Yap. Packing of graphs—a survey. *Discrete Mathematics*, 72(1):395–404, 1988.
- [3] David Burns and Seymour Schuster. Embedding $(p, p-1)$ graphs in their complements. *Israel Journal of Mathematics*, 30(4):313–320, 1978.
- [4] Ralph J Faudree, Cecil C Rousseau, Richard H Schelp, and Seymour Schuster. Embedding graphs in their complements. *Czechoslovak Mathematical Journal*, 31(1):53–62, 1981.
- [5] SM Hedetniemi, ST Hedetniemi, and PJ Slater. A note on packing two trees into K_n . *Ars Combin*, 11:149–153, 1981.
- [6] Hamamache Kheddouci, Jean-François Saclé, and Mariusz Woźniak. Packing two copies of a tree into its fourth power. *Discrete Mathematics*, 213(1-3):169–178, 2000.
- [7] Agnieszka Görlich, Monika Piłśniak, Mariusz Woźniak, and Irmina A Zioło. A note on embedding graphs without short cycles. *Discrete mathematics*, 286(1):75–77, 2004.
- [8] Atsushi Kaneko and Kazuhiro Suzuki. Packing two copies of a tree into its third power. *Discrete Mathematics*, 306(21):2779 – 2785, 2006.
- [9] Andrzej Ehrenfeucht, Tero Harju, and Grzegorz Rozenberg. *The theory of 2-structures: a framework for decomposition and transformation of graphs*. World Scientific Publishing Company, 1999.

Special sessions

RECONSTRUCTION OF DIGRAPHS UP TO COMPLEMENTATION

Aymen Ben Amira

Department of Mathematics, College of Sciences
King Saud University
P. O. Box 2455, Riyadh 11451, Saudi Arabia
ayman.benamira@yahoo.fr

Jamel Dammak

Department of Mathematics
Faculty of Sciences of Sfax
B.P. 1171, 3000 Sfax, Tunisia
jdammak@yahoo.fr

Hamza Si Kaddour

ICJ, Department of Mathematics
University of Lyon, University Claude-Bernard Lyon 1
43 Bd du 11 Novembre 1918, 69622 Villeurbanne Cedex, France
sikaddour@univ-lyon1.fr

Dedicated with warmth and admiration to Maurice Pouzet at the occasion of his 75th birthday

ABSTRACT

We prove that if G and G' are two digraphs, (≤ 8) -hypomorphic up to complementation, then G and G' are isomorphic up to complementation; we prove also that the value 8 is optimal.

Keywords Digraph · Isomorphism · k -hypomorphy up to complementation · Boolean sum · Symmetric graph

1 Introduction

A *directed graph* or simply *digraph* G consists of a finite and nonempty set V of vertices together with a prescribed collection E of ordered pairs of distinct vertices, called the set of the *edges* of G . Such a digraph is denoted by $(V(G), E(G))$ or simply (V, E) . Given a digraph $G = (V, E)$, to each nonempty subset X of V associate the *subdigraph* $(X, E \cap (X \times X))$ of G induced by X denoted by $G_{\uparrow X}$. With each digraph $G = (V, E)$ associate its *dual* $G^* = (V, E^*)$ and its *complement* $\overline{G} = (V, \overline{E})$ defined as follows: Given $x \neq y \in V$, $(x, y) \in E^*$ if $(y, x) \in E$, and $(x, y) \in \overline{E}$ if $(x, y) \notin E$. Two interesting types of digraphs are symmetric digraphs and tournaments. A digraph $G = (V, E)$ is a *symmetric digraph* or *graph* (resp. *tournament*) whenever for $x \neq y \in V$, $(x, y) \in E$ if and only if $(y, x) \in E$ (resp. $(x, y) \in E$ and $(y, x) \notin E$ or conversely). Given two digraphs $G = (V, E)$ and $G' = (V', E')$, a bijection f from V onto V' is an *isomorphism* from G onto G' provided that for any $x, y \in V$, $(x, y) \in E$ if and only if $(f(x), f(y)) \in E'$. The digraphs G and G' are *isomorphic*, if there exists an isomorphism from one onto the other.

Given two digraphs G and G' on the same vertex set V . Let k be an integer with $0 < k < |V|$, the digraphs G and G' are *k -hypomorphic* if for every k -element subset X of V , the induced subdigraphs $G_{\uparrow X}$ and $G'_{\uparrow X}$ are isomorphic. The digraphs G and G' are *$(\leq k)$ -hypomorphic* if they are t -hypomorphic for each integer $t \leq k$. A digraph G is *k -reconstructible* if any digraph k -hypomorphic to G is isomorphic to G .

In 1970, R.Fraïssé asked what is the least integer k such that the digraphs are $(\leq k)$ -reconstructible. G.Lopez [8, 9] answered to this question by showing that $k = 6$.

Given two digraphs G and G' on the same vertex set V . They are *hereditarily isomorphic* [10] if for each nonempty subset X of V , the digraphs $G_{\uparrow X}$ and $G'_{\uparrow X}$ are isomorphic. They are *isomorphic up to complementation* (resp. *hemimorphic*) if G' is isomorphic to G or \overline{G} (resp. to G or G^*). They are *hereditarily isomorphic up to complementation* [2] if they are hereditarily isomorphic, or G' and \overline{G} are hereditarily isomorphic. Let k be a positive integer, the digraphs G and G' are *k -hypomorphic up to complementation* (resp. *k -hemimorphic*) if for every k -element subset X of V , the induced subdigraphs $G_{\uparrow X}$ and $G'_{\uparrow X}$ are isomorphic up to complementation (resp. hemimorphic). The digraphs G and G' are *$(\leq k)$ -hypomorphic up to complementation* (resp. *$(\leq k)$ -hemimorphic*) if they are t -hypomorphic up to complementation (resp. t -hemimorphic) for each integer $t \leq k$. A digraph G is *k -reconstructible up to complementation*

(resp. k -half-reconstructible) if any digraph k -hypomorphic up to complementation (resp. k -hemimorphic) to G is isomorphic up to complementation (resp. hemimorphic) to G . A digraph G is $(\leq k)$ -reconstructible up to complementation (resp. $(\leq k)$ -half-reconstructible) if any digraph $(\leq k)$ -hypomorphic up to complementation (resp. $(\leq k)$ -hemimorphic) to G is isomorphic up to complementation (resp. hemimorphic) to G .

In 1993, J.G.Hagendorf raised the $(\leq k)$ -half-reconstruction problem for digraphs and solved it with G.Lopez [6, 7], they showed that *the finite digraphs are (≤ 12) -half-reconstructible*. In 1995, Y.Boudabbous and G.Lopez [3] showed that *the finite tournaments are (≤ 7) -half-reconstructible*.

In 1999, P.Ille asked what is the least integer k such that the digraphs are $(\leq k)$ -reconstructible up to complementation. The case of symmetric graphs was solved by J.Dammak, G.Lopez, M.Pouzet and H.Si Kaddour [4, 5], they proved that, *the symmetric graphs on v vertices are t -reconstructible up to complementation* for every $4 \leq t \leq v - 3$. In fact, the case $t = v - 3$ was solved in [5].

For digraphs, we first obtained with B. Chaari [1] a partially answer which is Theorem 1.1 below.

Let $G = (V, E)$ and $G' = (V, E')$ be two digraphs, 2-hypomorphic up to complementation. *The boolean sum $G \dot{+} G'$ of G and G' is the symmetric digraph $U = (V, E(U))$ defined by $\{x, y\} \in E(U)$ if and only if $(x, y) \in E$ and $(x, y) \notin E'$, or $(x, y) \notin E$ and $(x, y) \in E'$.*

Theorem 1.1. *(Theorem 1.3 of [1]) Let G and G' be two digraphs on the same set V of $n \geq 4$ vertices such that G and G' are (≤ 5) -hypomorphic up to complementation. Let $U := G \dot{+} G'$. If U and \bar{U} are connected, then G and G' are hereditarily isomorphic up to complementation.*

2 Main result

Our main result, Theorem 2.1, extends Theorem 1.1. It says that 8 is the least integer k such that the digraphs are $(\leq k)$ -reconstructible up to complementation.

Theorem 2.1. *Let G and G' be two digraphs on the same set V of vertices such that G and G' are (≤ 8) -hypomorphic up to complementation. Then G and G' are isomorphic up to complementation. Moreover the value 8 is optimal.*

The optimality of the value 8 of Theorem 2.1 follows from the following result.

Proposition 2.2. *For all integer $n \geq 8$, there are two digraphs on the same set of n vertices, nonisomorphic up to complementation, which are (≤ 7) -hypomorphic up to complementation and not 8-hypomorphic up to complementation.*

References

- [1] A. Ben Amira, B. Chaari, J. Dammak and H. Si Kaddour, *The (≤ 5) -hypomorphy of digraphs up to complementation*, Arab Journal of Mathematical Sciences **25** (2019), no. 1, 1–16.
- [2] M. Bouaziz, Y. Boudabbous and N. El Amri, *Hereditary hemimorphy of $\{-k\}$ -hemimorphic tournaments for $k \geq 5$* . J. Korean Math. Soc. **48** (2011), no. 3, 599–626.
- [3] Y. Boudabbous and G. Lopez, *La relation différence et l'anti-isomorphie*, Math. Logic Quart. **41** (1995), no. 2, 268–280.
- [4] J. Dammak, G. Lopez, M. Pouzet and H. Si Kaddour, *Hypomorphy of graphs up to complementation*. JCTB, Series B **99** (2009), no. 1, 84–96.
- [5] J. Dammak, G. Lopez, M. Pouzet and H. Si Kaddour, *Boolean sum of graphs and reconstruction up to complementation*. Advances in Pure and Applied Mathematics **4** (2013), 315–349.
- [6] J. G. Hagendorf and G. Lopez, *La demi-reconstructibilité des relations binaires d'au moins 13 éléments*, C. R. Acad. Sci. Paris, t.**317**, Série I (1993), 7–12.
- [7] J. G. Hagendorf and G. Lopez, *Un théorème de demi-reconstruction des relations binaires de cardinal > 12* (2017), hal-01501643v1.
- [8] G. Lopez, *Deux résultats concernant la détermination d'une relation par les types d'isomorphie de ses restrictions*, C. R. Acad. Sci. Paris, t.**274**, Série A, (1972), 1525–1528.
- [9] G. Lopez, *Sur la détermination d'une relation par les types d'isomorphie de ses restrictions*, C. R. Acad. Sci. Paris, t.**275**, Série A (1972), 951–953.
- [10] K. B. Reid and C. Thomassen, *Strongly self-complementary and hereditarily isomorphic tournaments*. Monatsh. Math. **81** (1976), no. 4, 291–304.

BIG RAMSEY DEGREES OF THE UNIVERSAL HOMOGENEOUS PARTIAL ORDER ARE FINITE

Jan Hubička

Department of Applied Mathematics (KAM)
Charles University
Praha 1, 110 00
hubicka@kam.mff.cuni.cz

ABSTRACT

We show that the universal homogeneous partial order has finite big Ramsey degrees. Our proof uses the Carlson–Simpson theorem rather than (a strengthening of) the Halpern–Läuchli and Milliken tree theorem which is the main tool used to give bounds on big Ramsey degrees. We discuss two corollaries.

Keywords big Ramsey degree · Carlson–Simpson Theorem · structural Ramsey theory · homogeneous structures

1 Introduction

We consider graphs, partial orders and metric spaces as special cases of model-theoretic relational structures. Given structures \mathbf{A} and \mathbf{B} , we denote by (\mathbf{B}/\mathbf{A}) the set of all embeddings from \mathbf{A} to \mathbf{B} . We write $\mathbf{C} \rightarrow (\mathbf{B})_{k,l}^{\mathbf{A}}$ to denote the following statement: For every colouring χ of (\mathbf{C}/\mathbf{A}) with k colours, there exists an embedding $f : \mathbf{B} \rightarrow \mathbf{C}$ such that χ does not take more than l values on $(f(\mathbf{B})/\mathbf{A})$.

For a countably infinite structure \mathbf{B} and its finite substructure \mathbf{A} , the *big Ramsey degree* of \mathbf{A} in \mathbf{B} is the least number $L \in \omega \cup \{\omega\}$ such that $\mathbf{B} \rightarrow (\mathbf{B})_{k,L}^{\mathbf{A}}$ for every $k \in \omega$. We say that a countably infinite structure \mathbf{B} has *finite big Ramsey degrees* if the big Ramsey degree is finite for every finite substructure of \mathbf{B} .

A countable structure \mathbf{A} is called (*ultra*)*homogeneous* if every isomorphism between finite substructures extends to an automorphism of \mathbf{A} . It is well known that there is a (up to isomorphism) unique homogeneous partial order \mathbf{P} with the property that every countable partial order has embedding to \mathbf{P} . We call \mathbf{P} the *universal homogeneous partial order*. We prove the following.

Theorem 1.1. *The universal homogeneous partial order has finite big Ramsey degrees.*

The main novelty in our approach is the use of spaces described by parameter words in the context of big Ramsey degrees. We use an infinitary variant of the Graham–Rothschild Theorem [1] which is a direct consequence of the Carlson–Simpson Theorem [2]. This leads to a finer control over the sub-trees compared to constructions based on applications of the Milliken tree theorem [3] which was the main tool used by Laver and Devlin to show that the order of rationals has finite big Ramsey degrees [4], by Sauer to show that the random graph has big Ramsey degrees [5] and several followup results.

2 Applications

Big Ramsey degrees are studied mainly in the context of free amalgamation structures. Since the universal homogeneous partial order is not a free amalgamation structure, it represents an important new example which has additional consequences. Let us discuss two corollaries.

1. Let S be a set of non-negative reals such that $0 \in S$. A metric space $\mathbf{M} = (M, d)$ is S -metric space if for every $u, v \in M$ it holds that $d(u, v) \in S$. A countable S -metric space \mathbf{M} is a S -Urysohn metric space if it is homogeneous (that is, every isometry of its finite subspaces extends to an isometry from \mathbf{M} to \mathbf{M}) and every countable S -metric space embeds into it. Finite set of non-negative reals $S = \{0 = s_0 < s_1 < \dots < s_n\}$ is *tight* if $s_{i+j} \leq s_i + s_j$ for all $0 \leq i \leq j \leq i + j \leq n$ (see [6]). It follows from a classification by Sauer [7] that for every such S there exists an S -Urysohn space. Mašulović [6, Theorem 4.4] shows a way to represent all S -metric cases with finitely many distances (for every tight set S) as a partial order. We thus obtain:

Corollary 2.1. *Let S be a finite tight set of non-negative reals. Then the S -Urysohn space has finite big Ramsey degrees.*

This can be seen as a continuation of the research on (in)divisibility of metric spaces started by Delhommé, Laflamme, Pouzet and Sauer [8, 9] and by Nguyen Van Thé [10, 11].

2. Recall that there is a up to isomorphism unique homogeneous triangle-free graph \mathbf{H} (called the *universal homogeneous triangle-free graph*) such that every countable triangle-free graph embeds to \mathbf{H} . We also obtain the first combinatorial proof of the following recent result by Dobrinen:

Theorem 2.2 (Dobrinen 2020 [12]). *The universal homogeneous triangle-free graph has finite big Ramsey degrees.*

We shall remark that Theorem 2.2 was generalized to the universal homogeneous K_k -free graphs (for every $k > 2$) [13] and to free amalgamation classes in binary relational languages [14]. Generalizing our construction to structures in non-binary relational languages and to structures that can not be described by means of forbidden substructures with at most 3 vertices is presently work in progress based on results announced in [15].

Acknowledgement: Author is supported by project 18-13685Y of the Czech Science Foundation (GAČR), Center for Foundations of Modern Computer Science (Charles University project UNCE/SCI/004), by the PRIMUS/17/SCI/3 project of Charles University and by ERC Synergy grant DYNASNET 810115.

References

- [1] Ronald L. Graham and Bruce L. Rothschild. Ramsey’s theorem for n -parameter sets. *Transactions of the American Mathematical Society*, 159:257–292, 1971.
- [2] Timothy J. Carlson and Stephen G. Simpson. A dual form of Ramsey’s theorem. *Advances in Mathematics*, 53(3):265–290, 1984.
- [3] Keith R. Milliken. A Ramsey theorem for trees. *Journal of Combinatorial Theory, Series A*, 26(3):215–237, 1979.
- [4] Denis Devlin. *Some partition theorems and ultrafilters on ω* . PhD thesis, Dartmouth College, 1979.
- [5] Norbert W. Sauer. Coloring subgraphs of the Rado graph. *Combinatorica*, 26(2):231–253, 2006.
- [6] Dragan Mašulović. Pre-adjunctions and the Ramsey property. *European Journal of Combinatorics*, 70:268–283, 2018.
- [7] Norbert W. Sauer. Distance sets of Urysohn metric spaces. *Canadian Journal of Mathematics*, 65(1):222–240, 2013.
- [8] Christian Delhommé, Claude Laflamme, Maurice Pouzet, and Norbert W. Sauer. Divisibility of countable metric spaces. *European Journal of Combinatorics*, 28(6):1746–1769, 2007.
- [9] Christian Delhommé, Claude Laflamme, Maurice Pouzet, and Norbert W. Sauer. Indivisible ultrametric spaces. *Topology and its Applications*, 155(14):1462–1478, 2008.
- [10] Lionel Nguyen Van Thé. Ramsey degrees of finite ultrametric spaces, ultrametric Urysohn spaces and dynamics of their isometry groups. *European Journal of Combinatorics*, 30(4):934–945, 2009.
- [11] Lionel Nguyen Van Thé. *Structural Ramsey Theory of Metric Spaces and Topological Dynamics of Isometry Groups*. Memoirs of the American Mathematical Society. American Mathematical Society, 2010.
- [12] Natasha Dobrinen. The Ramsey theory of the universal homogeneous triangle-free graph. *Journal of Mathematical Logic*, page 2050012, 2020.
- [13] Natasha Dobrinen. The Ramsey theory of Henson graphs. *arXiv:1901.06660, submitted*, 2019.
- [14] Andy Zucker. A note on big Ramsey degrees. *arXiv preprint arXiv:2004.13162*, 2020.
- [15] Martin Balko, David Chodounský, Jan Hubička, Matěj Konečný, and Lluís Vena. Big Ramsey degrees of 3-uniform hypergraphs. *Acta Mathematica Universitatis Comenianae*, 88(3):415–422, 2019.

WELL QUASI ORDERING AND EMBEDDABILITY OF RELATIONAL STRUCTURES

Maurice Pouzet

Univ. Lyon, Université Claude-Bernard Lyon1, CNRS UMR 5203, Institut Camille Jordan
43 bd. 11 Novembre 1918, 69622 Villeurbanne Cedex, France
Mathematics & Statistics Department, University of Calgary, Calgary, Alberta, Canada T2N 1N4
pouzet@univ-lyon1.fr

ABSTRACT

A relational structure R is *embeddable* in a relational structure R' if R is isomorphic to an induced substructure of R' . In the late forties, Fraïssé, following the work of Cantor, Hausdorff and Sierpinski, pointed out the importance of the quasi-ordering of embeddability in the theory of relations. For example, he conjectured that the class of countable chains is well quasi ordered (w.q.o.) under embeddability, a conjecture positively solved by Laver in the early seventies with the use of the theory of better quasi ordering (b.q.o.), a far reaching strengthening of the notion of w.q.o., invented by Nash-Williams. Fraïssé also noted that basic notions about ordered sets (posets) like initial segments, ideals, chains and antichains have a direct counterpart in terms of relational structures. For example, a class \mathcal{C} of structures is *hereditary* if it contains every structure which can be embedded into some member of \mathcal{C} . Clearly, hereditary classes are initial segments of the class of relational structures quasi-ordered by embeddability. If R is a relational structure, the *age* of R is the set $Age(R)$ of finite restrictions of R considered up to isomorphism. This is an ideal of the poset made of finite structures considered up to isomorphism and ordered via embeddability. As shown by Fraïssé, every countable ideal has this form. Several results along these lines about hereditary classes of relational structures have been obtained. Recent years have seen a renewed interest for the study of those made of finite structures and notably for their profile. The *profile* of a hereditary class \mathcal{C} of finite structures considered up to isomorphism is the function $\varphi_{\mathcal{C}}$ which counts for every integer n the number of members of \mathcal{C} on n elements. General counting results as well as precise results for graphs, tournaments, ordered graphs and permutations have been obtained, with a particular emphasis on jumps in the growth of the profile. I will present some general results about hereditary classes, particularly on those which are w.q.o. (or even b.q.o.), notably on their height, ordinal length, Cantor-Bendixson and Vietoris rank. I will discuss extensions of Laver's theorem to hereditary classes of binary structures. I will illustrate the role of w.q.o. in the classification of hereditary classes of small growth. I will conclude with several problems, some going back to the seventies, on w.q.o. and hereditary classes of relational structures.

References

- [1] M.H. Albert and M.D. Atkinson, *Simple permutations and pattern restricted permutations*. *Discrete Mathematics*, **300** (2005) 1–15.
- [2] A. Atminas, V. Lozin, *Labelled induced subgraphs and well-quasi-ordering*, *Order* **32** (2015), no. 3, 313–328.
- [3] P.J. Cameron, *Orbits of permutation groups on unordered sets. II*. *J. London Math. Soc.* **23(2)** (1981), pp. 249–264.
- [4] P.J. Cameron, *Oligomorphic permutation groups*. Cambridge University Press, Cambridge, 1990.
- [5] P.J. Cameron, *The algebra of an age*. In *Model theory of groups and automorphism groups (Blaubeuren, 1995)*, pages 126–133. Cambridge Univ. Press, Cambridge, 1997.
- [6] P.J. Cameron, *On an algebra related to orbit-counting*. *J. Group Theory* **1(2)** (1998), 173–179.

- [7] E. Corominas, On better quasi-ordering countable trees. *Discrete Math.*, **53** (1985) 35–53.
- [8] D.H.J. de Jongh and R. Parikh, Well-partial orderings and hierarchies. *Nederl. Akad. Wetensch. Proc. Ser. A* **80=Indag. Math.** **39(3)** (1977) 195–207.
- [9] C. Delhommé, M. Pouzet, N. Sauer, G. Sági, Representation of ideals of relational structures, *Discrete Math.* **309** (2009), no. 6, 1374–1384.
- [10] G. Ding, Subgraphs and well-quasi-ordering, *Journal of Graph Theory*, **16**, no 5 (1992), 489-502.
- [11] A. Ehrenfeucht, T. Harju, G. Rozenberg, *The theory of 2-structures. A framework for decomposition and transformation of graphs.* World Scientific Publishing Co., Inc., River Edge, NJ, 1999.
- [12] R. Fraïssé, Sur la comparaison des types de relations. *C. R. Acad. Sci. Paris* **226**, (1948). 987-988.
- [13] R. Fraïssé, Sur la comparaison des types d'ordres. *C. R. Acad. Sci. Paris* **226**, (1948). 1330-1331.
- [14] R. Fraïssé, *Sur quelques classifications des systèmes de relations*, Thèse, Paris (1953), *Alger-Math.* **1** (1954), 35–182.
- [15] R. Fraïssé, Sur l'extension aux relations de quelques propriétés des ordres, *Ann. Sci. Ecole Norm. Sup.* **71** (1954), 361–388.
- [16] R. Fraïssé, Theory of relations. Revised edition. With an appendix by Norbert Sauer. *Studies in Logic and the Foundations of Mathematics*, 145. North-Holland Publishing Co., Amsterdam, 2000. ii+451.
- [17] C. Frasnay, *Quelques problèmes combinatoires concernant les ordres totaux et les relations monomorphes*. Thèse. Paris. *Annales Institut Fourier Grenoble* **15** (1965), 415–524.
- [18] D.H. Gottlieb, A class of incidence matrices, *Proc. Amer. Math. Soc.* **17** (1966), 1233–1237.
- [19] T. Gallai, Transitiv orientbare graphen. *Acta Math. Acad. Sci. Hungar.* **18** (1967), 25–66 (English translation by F. Maffray and M. Preissmann in J.J. Ramirez-Alfonsin and B. Reed (Eds), *Perfect graphs*, Wiley 2001, 25–66.
- [20] G. Higman, Ordering by divisibility in abstract algebras. *Proc. London Math. Soc.* **(3)** (1952), 326–336.
- [21] P. Jullien, Contribution à l'étude des types d'ordres dispersés, Thèse Doctorat d'État, Université de Marseille, 27 juin 1968.
- [22] W.M. Kantor, On incidence matrices of finite projective and affine spaces, *Math. Z.* **124** (1972), 315–318.
- [23] M. Klazar, Overview of general results in combinatorial enumeration, in *Permutation patterns*, London Math. Soc. Lecture Note Ser., Vol. 376, (2010), 3–40, Cambridge Univ. Press, Cambridge.
- [24] I. Kříž, J. Sgall, Well-quasiordering depends on the labels. *Acta Sci. Math. (Szeged)* **55** (1991), no. 1-2, 59–65.
- [25] J.B. Kruskal, The theory of well-quasi-ordering: a frequently discovered concept. *J. Com. Th.* **13** (1972), 297–305.
- [26] C.Laflamme, M.Pouzet, R.Woodrow, Equimorphy- the case of chains, *Archive for Mathematical Logic*, 56 (2017), no. 7-8, 811–829.
- [27] R. Laver, On Fraïssé's order type conjecture, *Ann. of Math. (2)* **93** (1971) 89-111.
- [28] R. Laver, An order type decomposition theorem. *Ann. of Math. (2)* **98** (1973), 96–119.
- [29] H.D. Macpherson, Growth rates in infinite graphs and permutation groups. *J. London Math. Soc.* **35**(1987) no2, 276–286.
- [30] H.D. Macpherson, M. Pouzet, and R.E. Woodrow, Countable structures of a given age. *The Journal of Symbolic Logic* **57** (1992), 992–1010.
- [31] A.I. Mal'cev, The metamathematics of algebraic systems. Collected papers: 1936-1967. Translated, edited, and provided with supplementary notes by Benjamin Franklin Wells, III. *Studies in Logic and the Foundations of Mathematics*, Vol. 66. North-Holland Publishing Co., Amsterdam-London, 1971. xviii+494 pp.
- [32] A. Marcone, Foundations of bqo theory, *Transactions of the A.M.S.* **345** no 2 (1994) 641-660.
- [33] A. Marcus, G. Tardös, Excluded permutation matrices and the Stanley-Wilf conjecture, *J. Combin. Theory, Ser. A* **107** (2004), 153–160.
- [34] E.C. Milner, Basic wqo- and bqo-theory. In *Graphs and order, I.Rival Ed. (Banff, Alta., 1984)*, pages 487–502. Reidel, Dordrecht, 1985.
- [35] C.St.J.A. Nash-Williams, On well-quasi-ordering infinite trees, *Proc., Phil., Soc.*, **61**, (1965), 697-720.
- [36] D. Oudrar, Sur l'énumération de structures discrètes: une approche par la théorie des relations. Thèse de doctorat, Université d'Alger USTHB à Bab Ezzouar, 28 sept. 2015, 249 pp. arXiv:1604.05839.

- [37] D. Oudrar, M. Pouzet, Profile and hereditary classes of relational structures, *J. of MVLSC* **27**, no 5-6 (2016), 475-500.
- [38] M. Pouzet, Un belordre d'abritement et ses rapports avec les bornes d'une multirelation. *Comptes rendus Acad. Sci. Paris* **274(A)** (1972), 1677-1680.
- [39] M. Pouzet, Application d'une propriété combinatoire des parties d'un ensemble aux groupes et aux relations. *Math. Z.* **150** (1976) no2, 117-134.
- [40] M. Pouzet, *Sur la théorie des relations*. Thèse d'état, Université Claude-Bernard, Lyon 1, 1978.
- [41] M. Pouzet, The asymptotic behavior of a class of counting functions. *Combinatorics 79 Part 2. M.DEZA and I.G.ROSENBERG Eds., Annals of Discrete Math.* **9** (1980), 223-224.
- [42] M. Pouzet, Applications of well quasi-ordering and better quasi-ordering. In *Graphs and order (Banff, Alta., 1984)*, pp. 503-519. Reidel, Dordrecht, 1985.
- [43] M. Pouzet and I.G. Rosenberg, Sperner properties for groups and relations, *Europ. J. Combinatorics* **7** (1986), 349-370.
- [44] M. Pouzet and M. Sobrani, Sandwiches of ages. *Ann. Pure Appl. Logic* **108** (2001) no3, 295-326.
- [45]
- [46] M.Pouzet, N.Thiéry, Some relational structures with polynomial growth and their associated algebras I. Quasi-polynomiality of the profile, *The Electronic J. of Combinatorics*, 20(2) (2013), 35pp.
- [47] M. Pouzet, When is the orbit algebra of a group an integral domain? Proof of a conjecture of P. J. Cameron. *Theor. Inform. Appl.* **42** (2008), no. 1, 83-103.
- [48] F.P. Ramsey, On a problem of formal logic, *Proc. London Math. Soc.* **30** (1930), 264-286.
- [49] N. Robertson, Neil, P.D. Seymour, Graph minors. A survey. *Surveys in combinatorics 1985 (Glasgow, 1985)*, 153-171, London Math. Soc. Lecture Note Ser., 103, Cambridge Univ. Press, Cambridge, 1985.
- [50] A. Robinson, *On the metamathematics of algebra*. Studies in Logic and the Foundations of Mathematics. North-Holland Publishing Co., Amsterdam, 1951. ix+195 pp.
- [51] J.G. Rosenstein, *Linear orderings*. Pure and Applied Mathematics, 98. Academic Press, Inc. [Harcourt Brace Jovanovich, Publishers], New York-London, 1982. xvii+487 pp.
- [52] D. Schmidt. *Well-partial orderings and their maximal order types*. Habilitation, University of Heidelberg, Heidelberg, 1978.
- [53] W. Sierpinski, Sur les types d'ordre des ensembles linéaires. *Fund. Math.* **37**, (1950), 253-264.
- [54] M. Sobrani, *Sur les âges de relations et quelques aspects homologiques des constructions D+M*. Thèse de Doctorat d'état, Université S.M. Ben Abdallah-Fez, Fez, 2002.
- [55] S. Thomassé, On better quasi ordering countable series-parallel orders, *Trans. Amer. Math Soc.* **352** (no 6) (1999), 2491-2505.
- [56] N. Zaguia, Chaînes d'idéaux et de sections initiales d'un ensemble ordonné, *Publ. Dép. Math. (Lyon) (N.S.), (7/D)* **97**, 1983.

ON RELATIONAL STRUCTURES WITH POLYNOMIAL PROFILE

Nicolas M. Thiéry

Laboratoire de Recherche en Informatique
Université Paris-Saclay, CNRS, 91405, Orsay, France.
Nicolas.Thiery@u-psud.fr

ABSTRACT

During this presentation, we will review the state of the following favorite conjecture of Maurice Pouzet: the profile of a relational structure with bounded signature or finite kernel is eventually a quasi-polynomial whenever the profile is bounded by some polynomial.

The *profile* of a relational structure R is the function φ_R which counts for every integer n the number, possibly infinite, $\varphi_R(n)$ of substructures of R induced on the n -element subsets, isomorphic substructures being identified.

The study of profiles started in the seventies; see [1] for a survey. More recently, the line of work became parallel to numerous researches about the behavior of counting functions for hereditary classes made of finite structures, like undirected graphs, posets, tournaments, ordered graphs, or permutations, which also enter into this frame; see [2] and [3] for a survey, and [4, 5, 6, 7, 8, 9, 10, 11, 12, 13]. These classes are *hereditary* in the sense that they contain all induced structures of each of their members; in several instances, members of these classes are counted up to isomorphism and with respect to their size.

Several interesting examples of profiles come from permutation groups. For example, if G is a permutation group on a set E , the function θ_G which counts for every integer n the number of orbits of the action of G on the n -element subsets of E , is a profile, the *orbital profile* of G . Groups whose orbital profiles take only finite values are called *oligomorphic*; their study, introduced by Cameron, is a whole research subject by itself [14, 15].

Results point out jumps in the behavior of these counting functions. Such jumps were for example announced for extensive hereditary classes in [16], with a proof for the jump from constant to linear published in [17]. The growth is typically polynomial or faster than any polynomial, though not necessarily exponential (as indicates the partition function). For example, the growth of an hereditary class of graphs is either polynomial or faster than the partition function [5]. In several instances, these counting functions are eventually quasi-polynomials, e.g. [5] for graphs and [10] for permutations.

In the case of orbital profiles, Cameron conjectured in the late seventies that, whenever the profile φ_G is bounded by a polynomial, it is asymptotically equivalent to a polynomial. In 1985, Macpherson further asked whether the **orbit algebra** of G – a graded commutative algebra invented by Cameron and whose Hilbert function is φ_G – is finitely generated; in which case the profile would be a quasi-polynomial.

All these elements led Pouzet to the following

Conjecture 1. [18] *The profile of a relational structure with bounded signature or finite kernel is eventually a quasi-polynomial whenever the profile is bounded by some polynomial.*

This conjecture holds if R is an undirected graph [5]. In [18] Pouzet and the author proved that it holds for any relational structure R admitting a finite *monomorphic decomposition*. This result was applied in [19] to show that the above conjecture holds for tournaments.

Recently, the conjecture was proven in the case of orbital profiles by Justine Falque [20] under the direction of the author. It results from a complete classification of oligomorphic permutation groups with profile bounded by a polynomial in terms of finite permutation groups with decorated block systems. It follows from the classification that the orbit algebras are essentially invariant rings of finite permutation groups; the latter are known to be finitely generated which resolves positively Macpherson's question. A key ingredient in this classification is the notion of blocks. This suggests to search

for an appropriate generalization of blocks to relational structures, of which the notion of monomorphic decomposition would be just a first approximation.

The time seems ripe as well to extend the exploration to subexponential profiles. Indeed, Braufeld recently gave a near complete description of the spectrum of sub exponential growth rates for orbital profiles, which confirms some longstanding conjectures of Macpherson. Also, Falque’s classification seems amenable to generalization to subexponential orbital profiles.

References

- [1] Maurice Pouzet. The profile of relations. *Glob. J. Pure Appl. Math.*, 2(3):237–272, 2006.
- [2] M. Klazar. Overview of some general results in combinatorial enumeration. *Arxiv preprint arXiv:0803.4292*, 2008.
- [3] Béla Bollobás. Hereditary properties of graphs: asymptotic enumeration, global structure, and colouring. In *Proceedings of the International Congress of Mathematicians, Vol. III (Berlin, 1998)*, number Extra Vol. III, pages 333–342 (electronic), 1998.
- [4] József Balogh, Béla Bollobás, and Robert Morris. Hereditary properties of combinatorial structures: posets and oriented graphs. *J. Graph Theory*, 56(4):311–332, 2007.
- [5] József Balogh, Béla Bollobás, Michael Saks, and Vera T. Sós. The unlabelled speed of a hereditary graph property. *J. Combin. Theory Ser. B*, 99(1):9–19, 2009.
- [6] Adam Marcus and Gábor Tardos. Excluded permutation matrices and the Stanley-Wilf conjecture. *J. Combin. Theory Ser. A*, 107(1):153–160, 2004.
- [7] M. H. Albert and M. D. Atkinson. Simple permutations and pattern restricted permutations. *Discrete Math.*, 300(1-3):1–15, 2005.
- [8] M. H. Albert, M. D. Atkinson, and Robert Brignall. Permutation classes of polynomial growth. *Ann. Comb.*, 11(3-4):249–264, 2007.
- [9] V. Vatter. Small permutation classes. *Proceedings of the London Mathematical Society*, 103(5):879–921, 2011. arXiv:0712.4006.
- [10] Tomáš Kaiser and Martin Klazar. On growth rates of closed permutation classes. *Electron. J. Combin.*, 9(2):Research paper 10, 20 pp. (electronic), 2002/03. Permutation patterns (Otago, 2003).
- [11] Martin Klazar. On growth rates of permutations, set partitions, ordered graphs and other objects. *Electron. J. Combin.*, 15(1):Research Paper 75, 22, 2008.
- [12] Robert Brignall, Sophie Huczynska, and Vincent Vatter. Decomposing simple permutations, with enumerative consequences. *Combinatorica*, 28(4):385–400, 2008.
- [13] Djamila Oudrar and Maurice Pouzet. Profile and hereditary classes of relational structures. In H.Ait Haddadene, I.Bouchemakh, M.Bouadar, and S.Bouroubi (LAID3), editors, *Proceedings ISOR’11, International Symposium on Operational Research, Algiers, Algeria, May 30-June 2, 2011*.
- [14] Peter J. Cameron. *Oligomorphic permutation groups*, volume 152 of *London Mathematical Society Lecture Note Series*. Cambridge University Press, Cambridge, 1990.
- [15] Peter Cameron. Oligomorphic permutation groups. In Mohan Delampady N. S. Narasimha Sastry, T. S. S. R. K. Rao and B. Rajeev, editors, *Perspectives in Mathematical Sciences II: Pure Mathematics*, pages 37–61. World Scientific, Singapore, 2009.
- [16] Maurice Pouzet. The asymptotic behavior of a class of counting functions. In M. Deza and I. G. Rosenberg, editors, *Combinatorics 79. Part II, Proceedings of the Colloquium held at the University of Montréal, Montreal, Que., June 11–16, 1979*, volume 9, pages 223–224. Elsevier, 1980.
- [17] Maurice Pouzet. Application de la notion de relation presque-enchaînable au dénombrement des restrictions finies d’une relation. *Z. Math. Logik Grundlag. Math.*, 27(4):289–332, 1981.
- [18] Maurice Pouzet and Nicolas M. Thiéry. Some relational structures with polynomial growth and their associated algebras I: Quasi-polynomiality of the profile. *Electron. J. Combin.*, 20(2):Paper 1, 35, 2013.
- [19] Youssef Boudabbous and Maurice Pouzet. The morphology of infinite tournaments; application to the growth of their profile. *European J. Combin.*, 31(2):461–481, 2010.
- [20] Justine Falque and Nicolas M. Thiéry. Classification of P-oligomorphic groups, conjectures of Cameron and Macpherson. Submitted, 39 pages, arXiv:2005.05296 [math.CO], May 2020.

RECURSIVE CONSTRUCTION OF THE MINIMAL PRIME DIGRAPHS

Mohammad Alzohairi
King Saud University, Saudi Arabia.
zohairi@ksu.edu.sa

Moncef Bouaziz
King Saud University, Saudi Arabia.
mbouaziz@ksu.edu.sa

Youssef Boudabbous
Université de la Réunion, France.
youssef.boudabbous@univ-reunion.fr

ABSTRACT

In a digraph D , a module is a vertex subset M such that every vertex outside M does not distinguish the vertices in M . A digraph D with more than two vertices is prime if the empty set, the singleton sets, and the full set of vertices are the only modules in D . A prime digraph D is k -minimal if there is some k -element vertex subset U such that no proper induced subdigraph of D containing U is prime. In this paper, we give a recursive procedure to construct the minimal prime digraphs.

Keywords Module · Prime · Isomorphism · Minimal prime digraph

1 Introduction

All digraphs mentioned here are finite, and have no loops and no multiple edges. Thus a digraph (or directed graph) D consists of a nonempty and finite set $V(D)$ of *vertices* with a collection $E(D)$ of ordered pairs of distinct vertices, called the set of *edges* of D . Such a digraph is denoted by $(V(D), E(D))$. For elementary definitions and notations in graph theory we follow [9]. In particular we recall that the subdigraph of a digraph D induced by a nonempty vertex subset X is denoted by $D[X]$, and if $|V(D)| \geq 2$, then for each vertex x , the subdigraph $D[V(D) \setminus \{x\}]$ is also denoted by $D - x$. Given a digraph D , the underlying graph of D is denoted by \tilde{D} , and the *complement* of D , defined by $V(\overline{D}) = V(D)$ and $E(\overline{D}) = (V(D)^2 \setminus \{(x, x) : x \in V(D)\}) \setminus E(D)$, is denoted by \overline{D} .

Let D be a digraph. A vertex subset M is a *module* (or a clan or an interval or an autonomous set) of D if every vertex outside M does not distinguish the vertices in M . The empty set, the singleton sets, and the full set of vertices are *trivial modules*. A digraph is *indecomposable* if all its modules are trivial; otherwise it is *decomposable*. Indecomposable digraphs with at least three vertices are *prime digraphs*. A partition \mathcal{P} of the vertex set $V(D)$ of D is a *modular partition* of D if all its elements are modules of D . It follows that the elements of \mathcal{P} may be considered as the vertices of a new digraph, the *quotient* of D by \mathcal{P} , denoted by D/\mathcal{P} , and defined on \mathcal{P} as follows: for any distinct elements X and Y of \mathcal{P} , $XY \in E(D/\mathcal{P})$ if $xy \in E(D)$ for any x and y with $x \in X$ and $y \in Y$. A vertex subset X is a *strong module* of D provided that X is a module of D , and for every module Y of D , if $X \cap Y \neq \emptyset$, then either $X \subseteq Y$ or $Y \subseteq X$. If $|V(D)| \geq 2$, then $\mathcal{P}(D)$ denotes the set of maximal, strong modules of D , under the inclusion, among the strong modules of D distinct from $V(D)$.

The following theorem gives Gallai's decomposition result.

Theorem 1.1 [7, 8] *Let D be a digraph with more than one vertex. The set $\mathcal{P}(D)$ is a modular partition of D , and the quotient $D/\mathcal{P}(D)$ is prime, or an acyclic tournament, or a complete digraph, or an empty digraph.*

Given a digraph D with more than one vertex, the quotient $D/\mathcal{P}(D)$ is the *frame* of D .

A prime digraph D is *minimal* for a nonempty vertex subset A if each proper induced subdigraph of D containing A is decomposable. In this case, we say that the digraph D is *A-minimal*. Given a positive integer k , a digraph

D is k -minimal if it is minimal for some k -set of vertices. This concept was introduced by Cournier and Ille [4]. They characterized the 1-minimal and 2-minimal digraphs. Alzohairi and Boudabbous [2] described the 3-minimal triangle-free graphs. Finally, Alzohairi [1] described the triangle-free graphs which are minimal for some nonstable 4-vertex subset. In this paper, given an integer k , with $k \geq 3$, we give a method for constructing the k -minimal prime digraphs from the $(k - 1)$ -minimal prime digraphs.

2 Results

First we establish the following separation principle which plays a crucial role in the proof of our main result.

Proposition 2.1 (*Separation principle*) *Let D be a prime digraph which is A -minimal, where A is a vertex subset with $|A| \geq 2$, and X be a vertex subset including A such that the frame of the subdigraph $D[X]$ is prime and $\mathcal{P}(D[X])$ has a unique non-singleton element M . Assume that there are two distinct vertices x and y in A such that $M = \{x, y\}$ or $M = \{x, y\} \cup \{s_1, \dots, s_p\}$, where $p \geq 1$, s_1, \dots, s_p are distinct vertices outside X , and $\{x, y\} \cup \{s_j : j < i\}$ is a module of $D - s_i$, for each element i of $\llbracket 1, p \rrbracket$.*

Then there is a vertex u outside X such that M is a module of $D - u$. Moreover, either $V(D) = X \cup \{u\}$ or the frame of $D[X \cup \{u\}]$ is prime with $M \cup \{u\} \in \mathcal{P}(D[X \cup \{u\}])$.

The key of the proof of Proposition 2.1 is the study of the prime subdigraphs (resp. the subdigraphs with prime frames) in a prime digraph, obtained by A. Ehrenfeucht and G. Rozenberg [6] (resp. Y. Boudabbous and P. Ille [3]).

Second we obtain our main result.

Theorem 2.2 *Let D be a prime digraph, and A be a k -element vertex subset with $k \geq 3$. If the digraph D is A -minimal, then one of the following assertions holds.*

1. *There is a vertex x in A such that D or $D - x$ is $(A \setminus \{x\})$ -minimal.*
2. *There are distinct vertices x and y in A such that D is obtained from some $(A \setminus \{x\})$ -minimal digraph H , with $x \notin V(H)$, by adding x and a sequence s_1, \dots, s_m of distinct vertices outside $V(H) \cup \{x\}$ with $m \geq 1$ such that the vertex subset $\{x, y\} \cup \{s_j, j < i\}$ is a module of $D - s_i$, for each element i of $\llbracket 1, m \rrbracket$. Moreover, if $m \geq 2$, then either $V(H)$ is a module of $D[V(H) \cup \{s_m\}]$, or there is a vertex u in $A \setminus \{x, y\}$ such that $\{u, s_m\}$ is a module of $D[V(H) \cup \{s_m\}]$, or $D[V(H) \cup \{s_m\}]$ is $((A \setminus \{x\}) \cup \{s_m\})$ -minimal.*
3. *The subset A is a stable set of an element W of $\{D, \overline{D}\}$, the elements of A are pendant vertices of the underlying graph \widetilde{W} of W , the corresponding edges of which form a matching in \widetilde{W} , there are a vertex x in A and an $(A \setminus \{x\})$ -minimal digraph H with $x \notin V(H)$, and there is a vertex u outside $V(H) \cup \{x\}$ such that $\widetilde{W}[V \setminus V(H)]$ is a path P with ends x and u and \widetilde{W} is obtained from the union of \widetilde{H} and P by adding a nonempty set of edges between u and $V(H) \setminus A$.*

References

- [1] M. ALZHAIRI, Triangle-free graphs which are minimal for some nonstable 4-vertex subset, Arab J. Math. Sc. Volume 21, Issue 2, 159-169 (2015).
- [2] M. ALZHAIRI AND Y. BOUDABBOUS, 3-minimal triangle-free graphs, Discrete Math. 331, 3-8 (2014).
- [3] Y. BOUDABBOUS AND P. ILLE, Cut-primitive directed graphs versus clan-primitive directed graphs, Adv. Pure Appl. Math. 1, 223-231 (2010).
- [4] A. COURNIER AND P. ILLE, Minimal indecomposable graphs, Discrete Math. 183, 61-80 (1998).
- [5] A. EHRENFUCHT, T. HARJU AND G. ROZENBERG, The Theory of 2-Structures. A Framework for Decomposition and Transformation of Graphs, World Scientific, Singapore (1999).
- [6] A. EHRENFUCHT AND G. ROZENBERG, Primitivity is hereditary for 2-structures, fundamental study, Theoret. Comput. Sci. 3 (70), 343-358 (1990).
- [7] T. GALLAI, Transitiv orientierbare Graphen, Acta Math. Acad. Sci. Hungar. 18, 25-66 (1967).
- [8] F. MAFFRAY AND M. PREISSMANN, A translation of Tibor Gallai's paper: Transitiv orientierbare Graphen, In: Perfect graphs, J.L. Ramirez-Alfonsin and B.A. Reed Eds., J. Wiley, 25-66 (2001).
- [9] D. WEST, Introduction to Graph Theory, second ed., Prentice Hall, (2001).

Abstract of the invited talks

THE COLORFUL WORLD OF RAINBOW SETS

Ron Aharoni
Department of Mathematics
Technion, Haifa, Israel
raharoni@gmail.com

Given a family of sets, a *partial choice function* chooses elements from some of the sets. The image of such a function is called a *rainbow set*, the name originating in viewing the sets as “colors” of the elements. In this context the goal is typically obtaining a partial choice function f such that either:

- (I) $Dom(f)$ is “large”, while $Im(f)$ is “small”, or
- (II) $Dom(f)$ is “small”, while $Im(f)$ is “large”.

“Small” means here belonging to a given simplicial complex (the name topologists use for “a closed down family of sets”), particular to the given setting. As to “large”, it means different things in (I) and in (II): in (I) it means “full”, or more generally, spanning in a given matroid on the family of sets, while in (II) it means NOT belonging to some given simplicial complex.

A classical result of type (I) is Hall’s theorem, in which the domain is required to be all sets, and the “small-ness” of the image is injectivity. A famous result of type (II) is the Bárány-Lovász colorful version of Caratheodory’s theorem.

Theorem 1. [Bárány[1]] *If S_1, \dots, S_{d+1} are sets of vectors in \mathbb{R}^d satisfying $\vec{v} \in conv(S_i)$ for all $i \leq d + 1$, then there exists a rainbow set S such that $\vec{v} \in conv(S)$.*

I will explain why the two types of theorems are one and the same, when viewed from a topological angle, and tell about topological tools used to prove theorems of both types.

References

- [1] Imre Bárány and Roman N. Karasev. Notes about the carathéodory number. *Discret. Comput. Geom.*, 48(3):783–792, 2012.

F₃-RECONSTRUCTION

Youssef Boudabbous and Christian Delhomme

Laboratoire d'Informatique et de Mathématiques (LIM), Université de la Réunion.
youssef.boudabbous@univ-reunion.fr and christian.delhomme@univ-reunion.fr

ABSTRACT

Two binary relational structures of a same signature are $(\leq k)$ -hypomorphic if they have the same vertex set and their restrictions to each set of at most k vertices are isomorphic. A binary relational structure is $(\leq k)$ -reconstructible if it is isomorphic with each structure it is $(\leq k)$ -hypomorphic with. We establish an inductive characterisation of pairs of (≤ 3) -hypomorphic binary relational structures. We infer a characterisation of (≤ 3) -reconstructibility for bi-founded binary relational structures. A binary relational structure is bi-founded if it has no infinite set of pairwise comparable strong modules. On the one hand, we describe operations generating exactly the class of (≤ 3) -reconstructible bi-founded binary relational structures from singleton ones. On the other hand, this characterisation can be formulated in terms of restrictions on the structuration of the tree of robust modules of the structure. This allows in particular the extension of [BL05] : *a bi-founded tournament is (≤ 3) -reconstructible if and only if all its modules are selfdual*. Furthermore we show that the restrictions on structuration above do not characterise (≤ 3) -reconstructibility on the natural next classes generalising bi-founded structures, namely the class of founded structures (structures of which the collection of strong modules is well-founded for inclusion), and the class of co-founded structures (structures of which the collection of strong modules is well-founded for the reverse of inclusion, equivalently of which every strong module is robust, corresponding to [HR94] class of completely decomposable structures). Indeed we provide examples of founded, resp. co-founded, non (≤ 3) -reconstructible tournaments of which every module is selfdual.

We consider a set Λ , of labels, endowed with an involution $\lambda \mapsto \lambda^*$. A (reversible) Λ -2-structure, of vertex set V , is a mapping $\mathfrak{A} : V_*^2 \rightarrow \Lambda$ defined on the set of ordered pairs of distinct vertices, satisfying $\mathfrak{A}(y, x) = (\mathfrak{A}(x, y))^*$. We denote by $\vec{\Lambda}$ the set of non-selfdual labels, *i.e.* of these $\lambda \in \Lambda$ such that $\lambda^* \neq \lambda$. An *arc* of a Λ -2-structure \mathfrak{A} is an ordered pair (x, y) of distinct vertices such that $\mathfrak{A}(x, y) \in \vec{\Lambda}$, (or $\mathfrak{A}(y, x) \neq \mathfrak{A}(x, y)$). Given a non-selfdual label $\lambda \in \vec{\Lambda}$, a λ -*tournament* is a 2-structure of range included in $\{\lambda, \lambda^*\}$; a λ -*linear* structure is one of which the vertex set is linearly strictly ordered by $\mathfrak{A}(x, y) = \lambda$. A *modular partition* of a 2-structure is a partition of its vertex-set such that the label of an ordered pair (x, y) transverse to this partition depends only on the ordered pair of classes of x and y , yielding a quotient structure, of which the vertices are the classes of the partition. A *module* is a set of vertices empty or occurring as a class of a modular partition. A 3-vertex 2-structure is a *peak*, resp. a *flag*, if this is a non-tournament admitting a 2-vertex tournament quotient, resp. if its three unordered pairs of vertices are pairwise non-isomorphic. A 2-structure is *arc-connected* if the simple graph defined on its vertex set by $\mathfrak{A}(x, y) \in \vec{\Lambda}$ is connected.

A 2-structure is *prime* if it is indecomposable (its only modular partitions are the coarse and the discrete ones) and has more than two vertices. A nonempty 2-structure is *basic* if it is prime or linear or constant. Each nonempty 2-structure \mathfrak{A} admits a finest basic quotient. The structure is *robust* if the corresponding modular partition is not coarse or the vertex set is a singleton, in which case the classes of this partition are the *components* of \mathfrak{A} and the quotient is the *frame* of \mathfrak{A} . A structure with a prime quotient admits this frame as unique prime quotient.

The *dual* of a 2-structure \mathfrak{A} is the structure \mathfrak{A}^* with the same vertex set given by $\mathfrak{A}^*(x, y) = \mathfrak{A}(y, x)$. Then \mathfrak{A} is *selfdual* if it is isomorphic to \mathfrak{A}^* . The *neutral uniformisation* of a 2-structure \mathfrak{A} is the structure $\tilde{\mathfrak{A}}$ obtained from \mathfrak{A} by identifying all selfdual labels. If this neutral uniformisation $\tilde{\mathfrak{A}}$ has a prime quotient then the structure obtained from it by reversing all arcs transverse to its components is the *pseudodual* of \mathfrak{A} .

Definition 1 (F_3 -special structure) A Λ -2-structure \mathfrak{A} is λ -special, for a label $\lambda \in \overrightarrow{\Lambda}$, if it satisfies the two points below. Say that \mathfrak{A} is special if it is λ -special for some λ .

1. \mathfrak{A} is arc-connected, peak-free and admits a prime quotient.

In this case, its neutral uniformisation $\tilde{\mathfrak{A}}$ too has these three properties.

2. Each component of $\tilde{\mathfrak{A}}$ is a λ -tournament and no arc of any flag is transverse to such components.

Definition 2 (F_3 -specific substitution) Say that a substitution $\mathfrak{B}[\mathfrak{A}_v : v \in V]$ of nonempty structures along a nonempty non-singleton structure is specific if it satisfies one of the following three properties :

1. \mathfrak{B} is constant ;
2. \mathfrak{B} is prime non-special ;
3. there is a non-selfdual label $\lambda \in \overrightarrow{\Lambda}$ for which one of the two properties below is satisfied, in which case the substitution is said to be λ -specific :
 - (a) \mathfrak{B} is λ -linear and one of the two properties below is satisfied :
 - i. \mathfrak{B} is finite and the summands \mathfrak{A}_v are pairwise isomorphic λ -tournaments ;
 - ii. A. between any two λ -tournament summands there lies a non λ -tournament summand,
B. each non λ -tournament summand fails to have any non-coarse λ -linear quotient ;
 - (b) \mathfrak{B} is prime and λ -special and the following two properties are satisfied :
 - i. the summands are λ -tournaments,
 - ii. there exists an isomorphism $\varphi : \mathfrak{B} \rightarrow \mathfrak{B}^{*\tilde{\mathcal{P}}}$, from \mathfrak{B} onto its pseudodual, such that for each vertex $v \in V$ of \mathfrak{B} , $\mathfrak{A}_{\varphi(v)}$ is isomorphic to \mathfrak{A}_v (in particular \mathfrak{B} is self-pseudodual, i.e., isomorphic to its pseudodual).

Definition 3 The class of nonempty short reversible Λ -2-structures is the closure of the class of singleton Λ -2-structures under substitutions along basic structures.

Theorem 1 The class of nonempty short F_3 -reconstructible reversible Λ -2-structures is the closure of the class of singleton Λ -2-structures under specific substitutions.

Remark 1 For a λ -special structure \mathfrak{A} to be F_3 -reconstructible it suffices that its components be F_3 -reconstructible and that \mathfrak{A} be isomorphic to a particular F_3 -binom, viz. to its pseudodual $\mathfrak{A}^{*\tilde{\mathcal{P}}}$, which is its unique binom, besides itself, if \mathfrak{A} is prime. Note that the components are λ -tournaments ; if the structure \mathfrak{A} is short then they are F_3 -reconstructible if and only if their modules are all selfdual.

References

- [BD14] Y. Boudabbous, C. Delhommé. $(\leq k)$ -reconstructible binary relations. Eur. J. Comb. 37 (2014), 43–67.
- [BL05] Y. Boudabbous, G. Lopez. The minimal non $(\leq k)$ -reconstructible relations. Discr. Math. 291 (2005) 19-40.
- [CD08] B. Courcelle, C. Delhommé. The modular decomposition of countable graphs. Definition and construction in monadic second-order logic. Theor. Comp. Sc. 394, n. 1-2, pp. 1-38 (2008).
- [F70] R. Fraïssé. Abritement entre relations et spécialement entre chaînes. Symposi. Math., Instituto Nazionale di Alta Mathematica 5 (1970), 203-251.
- [G67] T. Gallai. Transitiv orientierbare Graphen. Acta math. Acad. Sci. Hungar., 18, (1967), p. 25-66.
- [HLR13] J.-G. Hagendorf, G. Lopez and C. Rauzy. Caractérisation des classes de (≤ 3) -hypomorphie à l'aide d'interdits. Proyecciones Journal of Mathematics Vol. 32, No 2, pp. 91-105, 2013.
- [HR94] T. Harju, G. Rozenberg. Decomposition of infinite labeled 2-structures. Lec. N. Cmp. Sc. 812 (1994) 145-158.
- [L78] G. Lopez. L'indéformabilité des relations et multirelations binaires. Z. Math. Logik Grundlag. Math., 24, (1978), 303-317.
- [LR92] G. Lopez, C. Rauzy. Reconstruction of binary relations from their restrictions of cardinality 2, 3, 4 and $n - 1$. I, Z. Math. Log. Grundl. Math., 38 (1992), 27-37.

EXTREMAL PROBLEMS FOR BOOLEAN LATTICES AND THEIR QUOTIENTS

Dwight Duffus
Mathematics Department
Emory University
Atlanta, GA 30322 USA
dwightduffus@emory.edu

Dedicated to Professor Maurice Pouzet on the occasion of his 75th birthday

Many beautiful results and conjectures in the 1970's and 1980's concern extremal and symmetry properties of finite set systems and, in particular, the finite Boolean lattice $\mathcal{B}(n)$. This presentation concerns two types of questions, the second of which Maurice Pouzet and his collaborators studied extensively.

First, in the 1970's, Peter Frankl raised a number of questions about families of subsets of a finite set. Here is one posed by Daykin and Frankl [3] concerning the minimum width $w(\mathcal{C})$ of a convex subset of $\mathcal{B}(n)$.

Conjecture 1. *For any nonempty convex subset \mathcal{C} of $\mathcal{B}(n)$, $\frac{w(\mathcal{C})}{|\mathcal{C}|} \geq \frac{\binom{n}{\lfloor n/2 \rfloor}}{2^n}$.*

(Recall that \mathcal{C} is *convex* in $\mathcal{B}(n)$ if whenever $X, Y \in \mathcal{C}$ with $X \subseteq Z \subseteq Y$ then also $Z \in \mathcal{C}$.) We made little progress on the general conjecture beyond small cases but D. Howard, I. Leader and D. Duffus were able to show that Conjecture 1 holds for *binary downsets* in $\mathcal{B}(n)$ [4]. (For $A, B \subseteq [n]$, the *binary order* is given by $A <_b B$ if $\max(A \Delta B) \in B$. A downset of $\mathcal{B}(n)$ whose elements constitute an initial segment of $\mathcal{B}(n)$ with the binary order is a *binary downset*.) Also, it is not difficult to show that among all d -element downsets in $\mathcal{B}(n)$, the binary ones maximize the number of comparabilities and, so, minimize the incomparabilities. Since we are inclined to support Conjecture 1, it is natural to conjecture the following [4] (also proposed by J. Goldwasser [7]).

Conjecture 2. *Among all d -element downsets in $\mathcal{B}(n)$, the binary d -element downset has minimum width.*

We considered properties of convex families in $\mathcal{B}(n)$ that might help us to understand the relationship between width and size, in particular, partitions of convex families by width-many chains. Given elements $x < y$ in a partially ordered set X , write $x \prec y$ (and say y *covers* x) if y is an immediate successor of x . A chain C in X is *skipless* if $x \prec y$ in C implies $x \prec y$ in X . A partition of X into a family of chains is a *Dilworth partition* if there are $w(X)$ chains in the family. For brevity, call a Dilworth partition of X into skipless chains an *SD-partition* of X .

Theorem 1. [4] *Every convex subset of $\mathcal{B}(n)$ has an SD-partition.*

Still thinking about convex sets, B. Sands and D. Duffus became interested in covers of convex subsets of $\mathcal{B}(n)$ by small families of intervals: given $X \subseteq Y \subseteq [n]$, $[X, Y] = \{Z \mid X \subseteq Z \subseteq Y\}$ is the interval determined by X and Y . It is obvious that if a convex family \mathcal{C} in $\mathcal{B}(n)$ has r minimals and s maximals, it can be covered by $r \cdot s$ intervals. One can construct a convex family in a Boolean lattice that requires that many, as Frankl observed. What happens if we focus attention on convex subsets of $\mathcal{B}(n)$ defined by levels? For $1 \leq k \leq l \leq n$, let $\mathcal{B}(n; k, l) = \{S \subseteq [n] \mid k \leq |S| \leq l\}$.

We rediscovered a result of Voigt and Wegener [16]: $\mathcal{B}(n; k, l)$ can be covered by the minimum possible number, $\max\left(\binom{n}{k}, \binom{n}{l}\right)$, of intervals. We investigated finite distributive lattices D and found that an analogous result holds for convex subsets determined by the atoms and coatoms of D and have a conjecture for the smallest covering families of intervals determined by any two levels of D [5].

Keywords: Boolean lattice, convex family, Sperner property, quotient; **AMS Subj [2020]:** 06A07

The second type of problem concerns preservation of the Sperner property, the strong Sperner property, rank unimodality, rank symmetry and the existence of symmetric chain decompositions (SCDs) in quotients of $\mathcal{B}(n)$. (See [1] for definitions.) Stanley [13, 14, 15] is concerned with quotients of a partially ordered set P defined by subgroups of the automorphism group of P . Pouzet [10] and Pouzet and Rosenberg [11] study more general quotients on P defined by *hereditary equivalences* with ordering induced from that on P . The new ordered set is called the *age* of the equivalence on P . The main tools in Pouzet’s work are linear algebraic as is the case with Stanley’s papers though he also employs methods from algebraic geometry.

These papers settled many of the questions about preserving symmetry properties with a couple of notable exceptions. First, the existence of SCDs does not follow from their general theorems – both Stanley and Pouzet have raised several specific questions and it is possible that all quotients $\mathcal{B}(n)/G$ by subgroups G of S_n have SCDs [2]. Progress has been slow (see, for instance, [17] and [6]). (Stanley gives an interesting explanation why linear algebra does not provide us with SCDs – see Section 7 in [13]).

Another question that has survived is whether the collection of all downsets of $\mathcal{B}(n)$, again ordered by containment, has the Sperner property. This partially ordered set is a distributive lattice, in fact, is the free distributive lattice $FD(n)$ on n generators and is a sublattice of $\mathcal{B}(2^n)$. It does not appear that $FD(n)$ can be obtained from $\mathcal{B}(2^n)$ as a quotient defined by a subgroup of S_{2^n} or as the age of a hereditary equivalence. However, one can show that $FD(n)$ can be obtained by a series of n “compressions” applied to the subsets of $\mathcal{B}(n)$, where $\mathcal{B}(n)$ is labelled by $[2^n]$ using the binary order. We want to see if the linear algebraic approach used by Pouzet and Rosenberg [11] can be applied in conjunction with these compressions to find families of disjoint chains in $FD(n)$, which would imply that $FD(n)$ has the Sperner property.

It is interesting to note that the maximum size of an antichain in $FD(n)$ determines the chromatic number of an iterated arc graph (see Theorem 3 in [12]). Were $FD(n)$ known to be Sperner and rank unimodal, its width would be the number of downsets in $\mathcal{B}(n)$ of size 2^{n-1} . This has been verified for $n \leq 6$ and has been conjectured for all n [9]. It would be (more than) enough to show that $FD(n)$ has a symmetric chain decomposition.

References

- [1] I. Anderson, *Combinatorics of finite sets*, Clarendon Press, Oxford (1987)
- [2] E. R. Canfield and S. Mason, When is a quotient of the Boolean lattice a symmetric chain order? Preprint (2006)
- [3] D. E. Daykin and P. Frankl, Inequalities for subsets of a set and KLYM posets, *SIAM J. Alg. Disc. Meth.* **4** (1983) 67 - 69
- [4] D. Duffus D. Howard, I. Leader, The width of downsets, *Europ. J. Combinatorics* **79** (2019) 46 - 59
- [5] D. Duffus and B. Sands, Covers of convex subsets of distributive lattices by intervals, in preparation.
- [6] D. Duffus and K. Thayer, Symmetric chain decompositions of quotients by wreath products, *Electronic J. Combin.* **22(2)** (2015) #P2.35
- [7] J. Goldwasser, personal communication (2015)
- [8] C. Greene and D. J. Kleitman, Strong versions of Sperner’s theorem, *J. Combin. Theory Ser. A* **20** (1976) 80 - 88
- [9] R. W. McHard, *Sperner properties of the ideals of a Boolean lattice*, Ph.D.Thesis, UC Riverside (2009)
- [10] M. Pouzet, Application d’une propriété combinatoire des parties d’un ensemble aux groupes and aux relations, *Math Z.* **150** (1976) 117 - 134
- [11] M. Pouzet and I. G. Rosenberg, Sperner properties for groups and relations, *Europ. J. Combinatorics* **7** (1986) 349 - 370
- [12] D. Rorabaugh, C. Tardif, D. Wehlau, I. Zaguia, Iterated arc graphs, *Comment. Math. Univ. Carolin.* **59** (2018) 277 - 283
- [13] R. P. Stanley, Weyl groups, the hard Lefschetz theorem, and the Sperner property, *SIAM J. Alg. Disc. Meth.* **1** (1980) 168 - 184
- [14] R. P. Stanley, Some aspects of groups acting on finite posets, *J. Combinatorial Theory A* **32** (1982) 132 - 161
- [15] R. P. Stanley, Quotients of Peck posets, *Order* **1** (1984) 29 - 34
- [16] B. Voigt and I. Wegener, A remark on minimal polynomials of Boolean functions, Report No. 88539-OR, Forschungsinstitut für Diskrete Mathematik, Bonn.
- [17] D. West, A symmetric chain decomposition of $L(n, 4)$, *European J. Combin.* **1** (1980) 379 - 383

ON LOGICS THAT MAKE A BRIDGE FROM THE DISCRETE TO THE CONTINUOUS

Mirna Džamonja
Membre Associée,
IHPST, CNRS-Université Panthéon-Sorbonne
Paris, France
logique.consult@gmail.com
<https://www.logiqueconsult.eu>

ABSTRACT

We study logics which model the passage between an infinite sequence of finite models to an uncountable limiting object, such as is the case in the context of graphons. Of particular interest is the connection between the countable and the uncountable object that one obtains as the union versus the combinatorial limit of the same sequence.

Keywords logics for structural convergence · graphon · Chu order

1 Introduction

First order logic (FOL) is an epitome of mathematical elegance, with semantics and syntax perfectly matched through the Completeness Theorem, as well as strong properties such as Compactness (a consequence of Completeness) and the Löwenheim-Skolem theorems. It is very useful for discrete mathematics of infinite models, such as algebra or infinite graph theory. The situation changes when one needs to step out either in the direction of the continuity, such as in mathematical analysis, or in the direction of finite models, such as frequently studied in computer sciences. For the former, the first order logic is not expressive enough, as even the simple idea of convergence is not expressible in FOL, and for the latter, FOL is too expressive and far from being decidable. In either case, one needs to change the approach if wanting to use logic in these applications. Something has to give either from the syntax or from the semantics side, since there are theorems which basically characterise FOL as the only logic with the properties given above.

One way of increasing the expressibility of FOL is to go through the realm of so called “strong” logics, while a way to bound its expressibility is to go through “weak” logics. Strength is often obtained by increasing the syntactic ability through a more permissive use of quantifiers or connectives, while weakening FOL may go through guarding or fragmenting. The notions of weakness and strength can be made formal using the idea of Chu transform (see [1]). Another way of changing FOL is to consider finite models.

Even though the Chu order between logics is far from being linear, we do obtain an image of discrete mathematics and finite structures being on the one side of FOL and the continuous mathematics being on the other. So, the finite and the continuous are firmly distinguished in the world of logic, just as they have been classically distinguished in the world of mathematics. However, in the world of mathematics, this distinction, at least in the context of certain mathematical structures, such as graphs, has been bridged by recent developments of various kind of combinatorial limits, including graphons [2]. The main new idea here is that rather than considering a single finite graph, one considers an infinite sequence of graphs of increasing sizes. Through a conveniently chosen notion of convergence for such a sequence, one arrives to a *continuous* representation of the limit in the form of a measurable function, a graphon.

The discovery of graphons has revolutionised the way that discrete and continuous mathematics communicate and has had many applications, from theoretical computer sciences to statistical physics. Yet, this development has not yet been understood from the point of view of logic, which is a strong motivation to what we propose to do.

2 Abstract logics that deal with countable sequence of finite models.

For simplicity we shall only deal with models of relational vocabularies τ and, for this abstract, the reader may concentrate on graph. We let $\mathcal{L}_{\omega,\omega}(\tau)$ be the set of all FOL formulas obtained from τ .

Definition 2.1 A logic is a triple of the form $\mathfrak{L} = (L, \models_{\mathfrak{L}}, S)$ where $\models_{\mathfrak{L}} \subseteq S \times L$ and S comes with a notion of isomorphism, usually understood from the context. We think of L as the set or class of sentences of \mathfrak{L} , S as a set or class of models of \mathfrak{L} and of $\models_{\mathfrak{L}}$ as the satisfaction relation.

We shall deal with several versions of the following idea, going back to the work of Karol Carpi [3] on chain logic :

Definition 2.2 A sequence model consists of a model \mathfrak{A} of τ and an increasing sequence $\langle A_n : n < \omega \rangle$ of finite models of τ whose union is the universe A of \mathfrak{A} .

Our logics $(L, \models_{\mathfrak{L}}, S)$ will usually have L which is a subset of the set of sentences of $\mathcal{L}_{\omega,\omega}(\tau)$, but they will mainly differ by what we consider to be S and how the notion of \models is defined. We give several examples.

Definition 2.3 • This is an instance of Karp's chain logic. Here S is formed of all sequence models but the notion of \models is changed to \models^c , where for a sentence φ of L , the notion $\mathfrak{A} \models^c \varphi$ is defined by induction of complexity of φ . Everything is the same as in the Tarski's definition of \models , except in the case of the existential quantifier, where we have

$$\mathfrak{A} \models^c (\exists x)\psi \text{ iff for some } n, A_n \models (\exists x)\psi.$$

- This is an example coming from the theory of graphons. It is given approximately since a proper development requires space. Here we consider for S only those models \mathfrak{A} obtained from sequences \bar{G} of graphs that converge in the cut metric, and hence (by the theory developed in [2]) each of them uniquely defines a graphon $\Gamma(\bar{G})$. For L we take those FOL sentences that are transferrable to graphons (a typical example would be a sentence bounding the homomorphism density $t(F, A_n)$ for a fixed graph F). Then we define

$$\mathfrak{A} \models^g \varphi \text{ iff } \Gamma(\bar{G}) \models \varphi.$$

- This is an example coming from the work of Nešetřil and Mendez (see [4] for the history and a didactic development), where the notion of first-order convergence of a sequence of finite first order structures is defined which to appropriate sequences of first order finite models \bar{A} associates a measure μ_A . We can define $L = \mathcal{L}_{\omega,\omega}(\tau)$, S to be the family of all models \mathfrak{A} obtained from sequences \bar{A} of structures that converge in first-order convergence and then define the satisfaction relation by

$$\mathfrak{A} \models^f \varphi \text{ iff } \int_S 1_{K(\varphi)} d\mu,$$

where the notions S and $K(\varphi)$ need to be properly defined.

The idea in all the examples is that there is a non first-order element required to determine the truth in a countable model: the knowledge of an infinite sequence, a measurable function or a measure. The talk will give a variety of results about these and other similar logics, for example with respect to the Chu order. It will investigate the implication between the position in the Chu order and the information carried through to the countable model \mathfrak{A} and will explore the connection between this countable model and the uncountable structural limit in the cases that the latter is defined.

References

- [1] Jouko Väänänen and Mirna Džamonja. Chain logic and shelah's infinitary logic. preprint arXiv:1908.01177, submitted., 2019.
- [2] László Lovász. *Large networks and graph limits*, volume 60 of *American Mathematical Society Colloquium Publications*. American Mathematical Society, Providence, RI, 2012.
- [3] Carol R. Karp. *Languages with expressions of infinite length*. PhD thesis, University of Southern California, 1959.
- [4] Jaroslav Nešetřil and Patrice Ossona de Mendez. First-order limits, an analytical perspective. *European J. Combin.*, 52:368–388, 2016.

GRAPH SEARCHES AND MAXIMAL CLIQUES STRUCTURE FOR COCOMPARABILITY GRAPHS

Derek Corneil
Department of Computer Science
University of Toronto
Toronto, Canada
dgc@cs.utoronto.ca

J er mie Dusart
IRIF, CNRS & Paris University
Paris, France
dusart@irif.fr

Michel Habib
IRIF, CNRS & Paris University
& Gang INRIA project
Paris, France
habib@irif.fr

This talk is in honour of Maurice Pouzet's 75 birthday, who from our very first meeting in Lyon (in the 80's) was able to pass on me his passion for ordered sets theory.

ABSTRACT

A cocomparability graph is a graph whose complement admits a transitive orientation. An interval graph is the intersection graph of a family of intervals on the real line. In this work we investigate the relationships between interval and cocomparability graphs. This study is motivated by recent results [1, 2] that show that for some problems, the algorithm used on interval graphs can also be used with small modifications on cocomparability graphs. Many of these algorithms are based on graph searches that preserve cocomparability orderings.

First we propose a characterization of cocomparability graphs via a lattice structure on the set of their maximal cliques. Using this characterization we can prove that every maximal interval subgraph of a cocomparability graph G is also a maximal chordal subgraph of G . Although the size of this lattice of maximal cliques can be exponential in the size of the graph, it can be used as a framework to design and prove algorithms on cocomparability graphs. In particular we show that a new graph search, namely Local Maximal Neighborhood Search (LocalMNS) leads to an algorithm to find in linear time a maximal interval subgraph of a cocomparability graph which improves on the current state of knowledge. Although computing all simplicial vertices is known to be equivalent to the recognition of triangle-free graphs or boolean multiplication, see [3, 4], we will show that our structural insights in cocomparability graphs together with the definition of a new graph search, allow us to achieve linear time on this class of graphs.

Keywords: (co)-comparability graphs, interval graphs, posets, maximal antichain lattices, maximal clique lattices, graph searches.

This work [5] is devoted to the study of *cocomparability graphs*, which are the complements of comparability graphs. A *comparability graph* is simply an undirected graph that admits a transitive acyclic orientation of its edges. Comparability graphs are well-studied and arise naturally in the process of modeling real-life problems, especially those involving partial orders. For a survey see [6, 7]. We also consider *interval graphs* which are the intersection graphs of a family of intervals on the real line. Comparability graphs and cocomparability graphs are well-known subclasses of perfect graphs [6]; and interval graphs are a well-known subclass of cocomparability graphs [8]. Clearly a given cocomparability graph G together with an acyclic transitive orientation of the edges of \overline{G} (the corresponding comparability graph) can be equivalently represented by a poset P_G ; thus new results in any of these three areas immediately translate to the other two areas. In this paper, we will often omit the translations but it is important to keep in mind that they exist.

A triple a, b, c of vertices forms an *asteroidal triple* if the vertices are pairwise independent, and every pair remains connected when the third vertex and its neighborhood are removed from the graph. An *asteroidal triple free graph* (AT-

free for short) is a graph with no asteroidal triples. It is well-known that AT-free graphs strictly contain cocomparability graphs, see [6].

A classical way to characterize a cocomparability graph is by means of an *umbrella-free* total ordering of its vertices.

In an ordering σ of $V(G)$, an *umbrella* is a triple of vertices x, y, z such that $x <_\sigma y <_\sigma z$, $xy, yz \notin E(G)$, and $xz \in E(G)$.

It has been observed in [9] that a graph is a cocomparability graph if and only if it admits an umbrella-free ordering. We will also call an umbrella-free ordering a *cocomp ordering*. In a similar way, interval graphs are characterized by interval orderings, where an *interval ordering* σ is an ordering of the graph's vertices that does not admit a triple of vertices x, y, z such that $x <_\sigma y <_\sigma z$, $xy \notin E(G)$, and $xz \in E(G)$. (Notice that an interval ordering is a cocomp ordering).

This work studies the relationships shared by interval and cocomparability graphs and is motivated by some recent results:

- For the Minimum Path Cover (MPC) Problem (a minimum set of paths such that each vertex of G belongs to exactly one path in the set), Corneil, Dalton and Habib showed that the greedy MPC algorithm for interval graphs, when applied to a Lexicographic Depth First Search (LDFS) cocomp ordering provides a certifying solution for cocomparability graphs (see [1]).
- A linear-time algorithm to compute a maximal matching for cocomparability graphs by Mertzios et al [10], based on a similar idea : preprocessing via a LDFS cocomp ordering. Other results within this framework can be found in [11].
- For the problem of producing a cocomp ordering (assuming the graph is cocomparability) Dusart and Habib showed that the multisweep Lexicographic Breadth First Search (LBFS)⁺ algorithm to find an interval ordering also finds a cocomp ordering ([2]). Note that $O(|V(G)|)$ LBFSs could be used in the worst case to guarantee these results.

For all these results the algorithm for cocomparability graphs is an easy extension of some algorithm already proposed for intervals graphs. Easy algorithmic extensions but a new proof is always needed and sometimes is quite involved. From this remark, natural questions arise:

- Do cocomparability graphs have some kind of hidden interval structure that allows the “lifting” of some interval graph algorithms to cocomparability graphs?
- What is the role played by graph searches LBFS and LDFS and are there other searches/problems where similar results hold?
- What is the meaning of the greediness of all these algorithms?

As mentioned previously, interval graphs form a strict subclass of cocomparability graphs. It is also known that every minimal triangulation of a cocomparability graph is an interval graph [12, 13]. We show that we can equip the set of maximal cliques of a cocomparability graph with a lattice structure where every chain of the lattice forms an interval graph. Note that an old Theorem by Gilmore and Hoffman states that a graph G is an interval graph if and only if the maximal cliques of G can be linearly ordered so that for every vertex x , the cliques containing x appear consecutively. Thus, through the lattice, a cocomparability graph can be seen as a special composition of interval graphs.

In particular, given a cocomparability graph G with P a transitive orientation of \overline{G} , the lattice $\mathcal{MA}(P)$ is formed on the set of maximal antichains of P (i.e., the maximal cliques of G). A graph $H = (V(G), E(H))$ with $E(H) \subseteq E(G)$ is a *maximal chordal* (respectively *interval*) *subgraph* if and only if H is a chordal graph and $\forall S \subseteq E(G) - E(H)$, $S \neq \emptyset$, $H' = (V(G), E(H) \cup S)$ is not a chordal (respectively interval) graph. We finally prove that every maximal interval subgraph of a cocomparability graph is also a maximal chordal subgraph.

Going back to graph searches, we can use the theory previously developed on the lattice $\mathcal{MA}(P)$. We present an algorithm Chainclique which on input a graph G and a total ordering σ of $V(G)$ returns an ordered set of cliques that collectively form an interval subgraph of G . We then introduce a new graph search (LocalMNS) that is very close to the classical Maximal Neighborhood Search (MNS) see [14] for a reference, which is a generalization of MCS, LDFS and LBFS. We show that Chainclique with σ being a LocalMNS cocomparability ordering of G returns a maximal interval subgraph of the cocomparability graph G ; this algorithm also gives us a way to compute a minimal interval extension of a partial order. We also uses Chainclique to compute in linear time the set of all simplicial vertices in a cocomparability graph.

References

- [1] Derek G. Corneil, Barnaby Dalton, and Michel Habib. LDFS-based certifying algorithm for the minimum path cover problem on cocomparability graphs. *SIAM J. Comput.*, 42(3):792–807, 2013.
- [2] Jérémie Dusart and Michel Habib. A new LBFS-based algorithm for cocomparability graph recognition. *to appear in Discrete Applied Mathematics*, 2016.
- [3] Dieter Kratsch and Jeremy P. Spinrad. Between $O(nm)$ and $O(n^{\alpha})$. *SIAM J. Comput.*, 36(2):310–325, 2006.
- [4] David Coudert and Guillaume Ducoffe. Revisiting decomposition by clique separators. *SIAM J. Discrete Math.*, 32(1):682–694, 2018.
- [5] Jérémie Dusart, Michel Habib, and Derek G. Corneil. Maximal cliques structure for cocomparability graphs and applications. *CoRR*, abs/1611.02002, 2016.
- [6] Martin Charles Golumbic. *Algorithmic Graph Theory and Perfect Graphs (Annals of Discrete Mathematics, Vol 57)*. North-Holland Publishing Co., Amsterdam, The Netherlands, The Netherlands, 2004.
- [7] Rolf H. Möhring. Algorithmic aspects of comparability graphs and interval graphs. In Ivan Rival, editor, *Graphs and Order*, volume 147 of *NATO ASI Series*, pages 41–101. Springer Netherlands, 1985.
- [8] Andreas Brandstädt, Van B. Le, and Jeremy P. Spinrad. *Graph Classes, a survey*. SIAM Monographs on Discrete Mathematics and Applications, 1999.
- [9] Dieter Kratsch and Lorna Stewart. Domination on cocomparability graphs. *SIAM J. Discrete Math.*, 6(3):400–417, 1993.
- [10] George B. Mertzios, André Nichterlein, and Rolf Niedermeier. A linear-time algorithm for maximum-cardinality matching on cocomparability graphs. *SIAM J. Discret. Math.*, 32(4):2820–2835, 2018.
- [11] Derek G. Corneil, Jérémie Dusart, Michel Habib, and E. Köhler. On the power of graph searching for cocomparability graphs. *SIAM J. Discrete Math.*, 30(1):569–591, 2016.
- [12] Rolf H. Möhring. Triangulating graphs without asteroidal triples. *Discrete Appl. Math.*, 64(3):281–287, February 1996.
- [13] Daniel Meister. Recognition and computation of minimal triangulations for AT-free claw-free and co-comparability graphs. *Discrete Applied Mathematics*, 146(3):193–218, 2005.
- [14] Derek G. Corneil and Richard Krueger. A unified view of graph searching. *SIAM J. Discrete Math.*, 22(4):1259–1276, 2008.

ORDERING INFINITIES

Joris van der Hoeven

CNRS, École polytechnique, Institut Polytechnique de Paris
Laboratoire d'informatique de l'École polytechnique (LIX, UMR 7161)
1, rue Honoré d'Estienne d'Orves
Bâtiment Alan Turing, CS35003
91120 Palaiseau, France
Email: vdhoeven@lix.polytechnique.fr

ABSTRACT

We survey three types of ordered differential fields with infinitely large and small elements: Hardy fields, transseries, and surreal numbers.

1 Introduction

Are there infinities that are “larger” than others? If so, how to carry out computations with infinite quantities, like $\infty + \infty$, $3\infty - \infty$, ∞^2 , ∞^∞ ? The mathematical study of this kind of questions started during the end of the 19th century.

On the one hand, Cantor introduced ordinal and cardinal arithmetic [6, 12], which allowed him to quantify the “size” of an infinite set. Slightly anterior to Cantor’s work, but less well known, du Bois-Reymond [?, 9, 10] developed a “calculus of infinities” to deal with growth rates of real functions in one variable, representing their “potential infinity” by an “actual infinite” quantity.

At first sight, Cantor’s discrete infinities (generalizing natural numbers) and du Bois Reymond’s growth orders (generalizing real numbers) are of a very different nature. We will survey the subsequent developments of these theories and recent progress towards their ultimate unification [2].

2 From ordinals to surreal numbers

Ordinal numbers can be regarded as a generalization of natural numbers, where we are “allowed to count beyond all numbers that we already constructed”:

$$0, 1, 2, 3, \dots, \omega, \omega + 1, \dots, \omega \cdot 2, \omega \cdot 2 + 1, \dots, \omega^2, \omega^2 + 1, \dots, \omega^3, \dots, \omega^\omega, \dots$$

In Conway’s theory of surreal numbers [7, 19], we may also construct numbers between already known numbers: given two sets $L < R$ of surreal numbers, there exists a simplest surreal number $\{L|R\}$ with $L < \{L|R\} < R$. This theory naturally extends Cantor’s theory of ordinal numbers:

$$0 = \{\}, 1 = \{0|\}, 2 = \{0, 1|\}, \dots, \omega = \{0, 1, \dots|\}, \omega + 1 = \{0, 1, \dots, \omega|\}, \dots$$

More interestingly, arithmetic operations on surreal numbers can be defined in a surprisingly elegant way, after which the class **No** of all surreal numbers turns out to be a totally ordered real closed field that contains \mathbb{R} . For instance:

$$-1 = \{|\}, \quad \omega - 1 = \{0, 1, \dots|\omega\}, \quad \frac{1}{2} = \{0|1\}, \quad \frac{1}{\omega} = \left\{0 \mid \dots, \frac{1}{4}, \frac{1}{2}, 1\right\}, \quad \dots$$

An interesting question is which other real calculus operations “naturally” extend to the surreal numbers. For instance, Gonshor defined an exponential on **No** with the same first order properties as the usual exponential [13]. More recently, Berarducci and Mantova showed how to define a derivation with respect to ω on **No** [4].

3 Growth orders

Du Bois-Reymond’s ideas were put on a firm bases by Hausdorff [16] and Hardy [14, 15]. Hardy introduced the set of “logarithmic-exponential functions” such as

$$e^{x+(\log x)^2+\sqrt{x}} + (\log x)^{\log(x-\sqrt{x}+3)} + 2^{\log x/\log \log x}.$$

He proved the remarkable fact that the set of germs of such functions at infinity form a real closed differential field. This was later generalized by Bourbaki [5], who defined a *Hardy field* to be any field of germs at infinity that is stable under differentiation.

Another formal direction of generalization is to consider so-called “transseries”, which are infinite logarithmic-exponential expressions such as

$$e^{e^x+2\frac{e^x}{x}+6\frac{e^x}{x^2}+\dots} + \frac{e^{e^x+2\frac{e^x}{x}+6\frac{e^x}{x^2}+\dots}}{x} + \frac{e^{e^x+2\frac{e^x}{x}+6\frac{e^x}{x^2}+\dots}}{x^2} + \dots + e^{x \log \log x} + \frac{1}{x} + \frac{1}{x^2} + \frac{1}{x^3} + \dots.$$

Transseries were introduced independently by Dahn–Göring [8] and Écalle [11], and their theory was further developed in [17, 18, 1]. Again, it turns out that the class of all transseries forms a totally ordered differential field.

4 H-fields

We have now seen three types of real closed differential fields with infinitely large quantities: the surreal numbers, Hardy fields, and the field of transseries. In each of the three cases, it turns out that the derivation and the ordering satisfy additional compatibility properties like $y > \mathbb{R} \implies y' > 0$. The notion of an “H-field” captures the most obvious common first order properties of this kind.

The field of transseries \mathbb{T} also satisfies several less obvious first order properties such as the intermediate value theorem [18]: given a differential polynomial $P \in \mathbb{T}[Y, Y', \dots, Y^{(r)}]$ and $u < v$ in \mathbb{T} with $P(u)P(v) < 0$, there exists a $y \in (u, v)$ with $P(y) = 0$. An H-field is said to be “H-closed” if it satisfies this and a few other closure properties. The main result of [1] is that the elementary theory of \mathbb{T} is completely axiomatized by the axioms of H-closed H-fields. Moreover, we proved a quantifier elimination theorem for a natural expansion of this theory.

The language of H-fields allows us to make the relations between surreal numbers, Hardy fields, and transseries more precise. For instance, the ordered differential field of surreal numbers \mathbf{No} is elementary equivalent to \mathbb{T} [3]. We conjecture that the same holds for all maximal Hardy fields. We also conjecture that there exists a natural isomorphism between \mathbf{No} and a suitable field \mathbf{Hy} of “hyperseries”—a generalization of transseries with functions such as the solution of $E_\omega(x+1) = \exp E_\omega(x)$. We refer to [2] for detailed statements and partial results.

References

- [1] M. Aschenbrenner, L. van den Dries, and J. van der Hoeven. *Asymptotic Differential Algebra and Model Theory of Transseries*. Number 195 in Annals of Mathematics studies. Princeton University Press, 2017.
- [2] M. Aschenbrenner, L. van den Dries, and J. van der Hoeven. On numbers, germs, and transseries. In *Proc. Int. Cong. of Math. 2018*, volume 1, pages 1–24. Rio de Janeiro, 2018.
- [3] M. Aschenbrenner, L. van den Dries, and J. van der Hoeven. The surreal numbers as a universal H-field. *J. Eur. Math. Soc.*, 21(4):1179–1199, 2019.
- [4] A. Berarducci and V. Mantova. Surreal numbers, derivations and transseries. *JEMS*, 20(2):339–390, 2018.
- [5] N. Bourbaki. *Fonctions d’une variable réelle*. Éléments de Mathématiques (Chap. 5). Hermann, 2-nd edition, 1961.
- [6] G. Cantor. *Sur les fondements de la théorie des ensembles transfinis*. Jacques Gabay, 1899. Reprint from les Mémoires de la Société des Sciences physiques et naturelles de Bordeaux.
- [7] J. H. Conway. *On numbers and games*. Academic Press, 1976.
- [8] B. I. Dahn and P. Göring. Notes on exponential-logarithmic terms. *Fundamenta Mathematicae*, 127:45–50, 1986.
- [9] P. du Bois-Reymond. Über asymptotische Werte, infinitäre Approximationen und infinitäre Auflösung von Gleichungen. *Math. Ann.*, 8:363–414, 1875.
- [10] P. du Bois-Reymond. Über die Paradoxen des Infinitärscalcüls. *Math. Ann.*, 11:149–167, 1877.

- [11] J. Écalle. *Introduction aux fonctions analysables et preuve constructive de la conjecture de Dulac*. Hermann, collection: Actuelles mathématiques, 1992.
- [12] Ph. Ehrlich. The rise of non-Archimedean mathematics and the roots of a misconception i: the emergence of non-Archimedean systems of magnitudes. *Arch. Hist. Exact Sci.*, 60:1–121, 2006.
- [13] H. Gonshor. *An Introduction to the Theory of Surreal Numbers*. Cambridge Univ. Press, 1986.
- [14] G. H. Hardy. *Orders of infinity*. Cambridge Univ. Press, 1910.
- [15] G. H. Hardy. Properties of logarithmico-exponential functions. *Proceedings of the London Mathematical Society*, 10(2):54–90, 1911.
- [16] F. Hausdorff. Grundzüge einer Theorie der geordneten Mengen. *Math. Ann.*, 65:435–505, 1908.
- [17] J. van der Hoeven. *Automatic asymptotics*. PhD thesis, École polytechnique, Palaiseau, France, 1997.
- [18] J. van der Hoeven. *Transseries and real differential algebra*, volume 1888 of *Lecture Notes in Mathematics*. Springer-Verlag, 2006.
- [19] D.E. Knuth. *Surreal Numbers: How Two Ex-students Turned on to Pure Mathematics and Found Total Happiness : a Mathematical Novelette*. Addison-Wesley Publishing Company, 1974.

MAURICE'S SIBLINGS

Claude Laflamme
Department of Mathematics & Statistics
University of Calgary
Calgary, Alberta
laflamme@ucalgary.ca

ABSTRACT

Two structures are called *siblings*, or *equimorphic*, if each embeds in the other. If they are infinite, these structures need not to be isomorphic. Yet finite substructures often play a large role in determining what these equimorphic structures are.

The main objective is to understand these equimorphic structures. In this direction a first step is often simply the ability to count them, and there two main conjectures relating the notions of equimorphy and isomorphy for infinite structures which are the motivation for this talk.

I will review some results obtained by Maurice and the Calgary group of Norbert Sauer, Robert Woodrow and myself during the last several years.

Keywords Graphs, trees, relational structures, equimorphy, isomorphy.

Summary

A *sibling* of a given (relational) structure R is any structure S which can be embedded into R , and vice versa. If R is finite, there is just one sibling. The famous Cantor-Bernstein-Schroeder Theorem states that this is the case even for infinite sets, structures in a language with pure equality: if there is an injection from one set to another and vice-versa, then there is a bijection between these two sets. The same situation occurs in other (categorical) structures such as vectors spaces, where embeddings are linear injective maps. But, as expected, it is not in general the case that equimorphic structures are isomorphic.

Thus, let $sib(R)$ be the number of siblings of R (in its category), these siblings being counted up to isomorphism. There are a few main conjectures at the center of this investigation.

The first one is the Bonato - Tardif conjecture, often referred to as the *Tree Alternative Conjecture*.

Conjecture [Bonato - Tardif 06]

Any tree T has either infinitely many twins, or none.

That is $sib(T) = 1$ or $sib(T) \geq \aleph_0$.

Here, trees are connected (undirected) graphs without any cycle. Bonato and Tardif proved that the conjecture holds for *rayless trees*, that is trees not containing an infinite path (also called a ray).

In 2009, Tyomkyn proved that the tree alternative property for rooted trees. At the same time he conjectured a simple characterization for locally finite trees having infinitely many siblings.

Conjecture [Tyomkin - 09]

$sib(T) \geq \aleph_0$ for every locally finite tree T having a non-surjective embedding, except only for the infinite path.

In [5], we verified the Bonato -Tardif conjecture in the case of scattered trees (that is trees not containing a subdivision of the binary tree), and the Tyomkin conjecture in the case of locally finite scattered trees.

A related conjecture was proposed by Thomassé around 2000 regarding countable relational structures made of at most countably many relations.

Conjecture [Thomassé - circa 2000]

If \mathcal{A} is a countable relational structure, then $\text{sib}(\mathcal{A}) = 1, \aleph_0$, or 2^{\aleph_0} .

A ‘special’ case is that $\text{sib}(\mathcal{A}) = 1$ or $\text{sib}(\mathcal{A}) \geq \aleph_0$ for any relational structure \mathcal{A} (countable or not).

The above conjectures are connected through the following subtle observation. Every sibling of a connected graph is connected, just in case $G \oplus 1$, the graph obtained by adding to G an isolated vertex is not a sibling; in particular every sibling of a tree T (as a binary relational structure) is a tree if and only if $T \oplus 1$ is not a sibling of T . Hence, for a tree T not equimorphic to $T \oplus 1$, the Bonato-Tardif conjecture and the special case of Thomassé’s conjecture are equivalent. On the other hand, if a tree T is equimorphic to $T \oplus 1$, the number of siblings of T is infinite and hence the special case of the Thomassé conjecture holds for those trees, and yet we do not know if the Bonato-Tardif conjecture holds.

The special case for graphs was considered by Bonato et al in [1], who proved it for rayless graphs. However both full cases of these conjectures remain unsolved for graphs, even in the case of loopless undirected graphs, and even for trees.

We verified the full conjecture for countable chains in [7], and the special case for any chain.

Further investigations of this conjecture naturally lead into the structure of the automorphism group of the relational structure. One important case is when that group is oligomorphic, that is the number of orbits of n -element subsets of the base set is finite for every integer n .

In [6], we showed that the number of siblings of a countable relational structure with an oligomorphic automorphism group is either one or infinite. Moreover it is one exactly when the structure is finitely partitionable, that is there is a partition of the domain of the structure into finitely many blocks such that every permutation preserving each block is an automorphism of the structure. This generalizes a result of Hodkinson & Macpherson in [4].

We will discuss these results, give some indication of the tools involved in their proofs, together with some recent directions and open problems.

References

- [1] A. Bonato, H. Bruhn, R. Diestel, P. Sprüssel Twins of rayless graphs. In *J. Combin. Theory Ser. B* 101 (2011), no. 1, 60–65.
- [2] A. Bonato, C. Tardif Mutually embeddable graphs and the tree alternative conjecture. In *J. Combin. Theory Ser. B* 96 (2006) no. 6, 874–880.
- [3] R. Halin Fixed configurations in graphs with small number of disjoint rays. In *R. Bodendiek (Ed) Contemporary Methods in Graph Theory, Bibliographisches Inst., Mannheim*, 1990, pp. 639-649.
- [4] I.M. Hodkinson, H.D. Macpherson Relational structures determined by their finite induced substructures. In *J. Symbolic Logic* 53 (1988), no. 1, 222–230.
- [5] C. Laflamme, M. Pouzet, N. Sauer Invariant subsets of scattered trees and the tree alternative property of Bonato and Tardif. In *Abh. Math. Semin. Univ. Hambg.* 87 (2017), no. 2, 369–408.
- [6] C. Laflamme, M. Pouzet, N. Sauer, R. Woodrow Siblings of an \aleph_0 -categorical relational structure. In *Proceedings of the BIRS conference on Homogenous Structures*, Banff 2015.
- [7] C. Laflamme, M. Pouzet, R. Woodrow Equimorphy: the case of chains. In *Arch. Math. Logic* 56 (2017), no. 7-8, 811–829.
- [8] S. Thomassé Conjectures on Countable Relations *Circulating manuscript*, 17p. 2000.
- [9] M. Tyomkyn A proof of the rooted tree alternative conjecture. In *Discrete Math.*, 309 (2009) 5963-5967.

APPLICATIONS OF ORDER TREES IN INFINITE GRAPHS

Max Pitz
Department of Mathematics
University of Hamburg
20146 Hamburg, Germany
max.pitz@uni-hamburg.de

ABSTRACT

Traditionally, the trees studied in infinite graphs are trees of height at most ω , with each node adjacent to its parent and its children (and every tree branch inducing a path or a ray). However, there is also a method, systematically introduced by Brochet and Diestel, of turning arbitrary well-founded order trees T into graphs, such that every T -branch induces a generalised path in the sense of Rado. In this talk I will give a gentle introduction to this method and then describe three recent applications of order trees to infinite graphs, with relevance for well-quasi orderings, normal spanning trees and end-structure, the last two solving long-standing open problems by Halin.

Keywords Normal tree orders · normal spanning trees · well-quasi orderings · minor antichains

1 Overview

Given an order tree (T, \leq) , we say that a graph $G = (V, E)$ is a T -graph if $V = T$, the ends of any edge $e = tt'$ are comparable in T , and the neighbours of any $t \in T$ are cofinal in $\overset{\circ}{[t]} := \{t' \in T : t' < t\}$. A T -graph G is *sparse* if the down-neighbourhood $N_{\downarrow}(t) := N(t) \cap \overset{\circ}{[t]}$ of any node t is of order type $\text{cf}(\overset{\circ}{[t]})$. These concepts have been introduced by Brochet and Diestel in [1]. The purpose of this contribution is to describe three recent applications of these T -graphs.

If a graph G is (isomorphic to) a T -graph for some order tree (T, \leq) , we say that (T, \leq) is a *normal tree order* for G . Not all graphs admit a normal tree order (consider an uncountable clique where every edge has been subdivided once) and it is an open problem to characterise the graphs which do.

Much more is known about which graphs admit a normal tree order (T, \leq) where (T, \leq) is a graph-theoretic tree (i.e. an order tree of height at most ω). In this case, T is called a *normal spanning tree* of G . This concept is due to Jung [2], who also offered a first characterization of graphs admitting a normal spanning tree. Another characterization has been conjectured by Halin [3]: Recall that a graph G has *countable colouring number* if there is a well-order on $V(G)$ such that every vertex has only finitely many neighbours that precede it in this well-order.

Conjecture 1 (Halin). *A connected graph G has a normal spanning tree if and only if every minor of G has countable colouring number.*

As the first result, I will describe a recent proof of this conjecture [4]. Even though the statement is about normal spanning trees, the proof uses the theory of normal tree orders in its full generality.

From Halin's conjecture, one obtains a forbidden minor characterization of the graphs admitting a normal spanning tree. Diestel and Leader have asked to classify the minor-minimal forbidden graphs in this list [5].

Problem 2 (Diestel and Leader). *Classify the minor-minimal forbidden graphs for the property of having a normal spanning tree up to minor-equivalence.*

Generalising the constructions of Thomas and Komjath that uncountable graphs are not well-quasi-ordered under the minor relation, as the second application I will describe a construction showing that any such list of forbidden minors

consistently contains arbitrarily large graphs, and in fact contains arbitrarily large antichains [6, 7]. These antichains consist of T -graphs for certain families of trees of height $\omega + 1$, using a topological idea of Stone about Baire spaces of uncountable weight from [8].

Finally, as the third application, a completely different topic: An *end* of a graph G is an equivalence class of rays, where two rays R and S of G are *equivalent* if and only if there are infinitely many vertex disjoint paths between R and S in G . The *degree* $\deg(\varepsilon)$ of an end ε is the maximum cardinality of a collection of pairwise disjoint rays in ε , which is well-defined by Halin [9].

Given a family $\mathcal{R} = (R_i : i \in I)$ of disjoint equivalent rays R_i in a graph G , we call a graph H on I a *ray graph* of \mathcal{R} in G if there exists a family \mathcal{P} of independent \mathcal{R} -paths¹ such that for each edge $ij \in H$ there are infinitely many disjoint R_i - R_j paths in \mathcal{P} . In [3], Halin proposed the following conjecture, with the aim of achieving a better understanding the combinatorics behind ends of large degree.

Conjecture 3 (Halin). *For every end ε of a graph G there is a degree witnessing collection \mathcal{R} of disjoint rays in ε with a connected ray graph.*

Halin’s conjecture is trivially true for ends of finite degree, and has been proven by Halin himself for ends of countable degree (the so-called *Halin’s grid theorem*). Despite numerous attempts, no further progress in Halin’s conjecture has been made up to now. Let $HC(\kappa)$ be the statement that Halin’s conjecture holds for all ends of degree κ .

Recently, we have clarified the truth of $HC(\kappa)$ for the first cardinals as follows [10]: $HC(\aleph_1)$ fails, $HC(\aleph_n)$ holds for all $2 \leq n \leq \omega$, $HC(\aleph_{\omega+1})$ fails again, and $HC(\aleph_{\omega+n})$ for $n \in \mathbb{N}$ with $n \geq 2$ is undecidable in ZFC. I will give an impression of our counterexamples which are built on certain T -graphs – in the case of $HC(\aleph_1)$ on a certain Aronszajn tree T , and in the case of $HC(\aleph_{\omega+n})$ on T -graphs arising from scales as in Shelah’s *pcf*-theory.

References

- [1] Jean-Michel Brochet and Reinhard Diestel. Normal tree orders for infinite graphs. *Transactions of the American Mathematical Society*, 345(2):871–895, 1994.
- [2] Heinz A. Jung. Wurzelbäume und unendliche Wege in Graphen. *Mathematische Nachrichten*, 41(1-3):1–22, 1969.
- [3] R. Halin. Miscellaneous problems on infinite graphs. *Journal of Graph Theory*, 35(2):128–151, 2000.
- [4] Max Pitz. Proof of Halin’s normal spanning tree conjecture. <https://arxiv.org/abs/2005.02833>, 2020.
- [5] R. Diestel and I. Leader. Normal spanning trees, Aronszajn trees and excluded minors. *Journal of the London Mathematical Society*, 63:16–32, 2001.
- [6] Max Pitz. A new obstruction for normal spanning trees. <https://arxiv.org/abs/2005.04150>, 2020.
- [7] Max Pitz. A note on minor antichains of uncountable graphs. <https://arxiv.org/abs/2005.05816>, 2020.
- [8] Arthur H Stone. On σ -discreteness and borel isomorphism. *American Journal of Mathematics*, 85(4):655–666, 1963.
- [9] R. Halin. Über die Maximalzahl fremder unendlicher Wege in Graphen. *Mathematische Nachrichten*, 30(1-2):63–85, 1965.
- [10] Stefan Geschke, Jan Kurkofka, Ruben Melcher, and Max Pitz. Halin’s ray graph conjecture. In preparation, 2020.

¹Paths that have precisely their end vertices on $\bigcup \mathcal{R}$.

SYNCHRONOUS PROGRAMMING OF REAL-TIME SYSTEMS *or* TURNING MATHEMATICS INTO TRUSTABLE CODE

Marc Pouzet
DIENS,
Ecole normale supérieure
45 rue d'Ulm, 75230 Paris
Marc.Pouzet@ens.fr

ABSTRACT

Large size and complex software now critically control and command airplanes, trains, cars and nuclear plants. This software interacts in real-time with a physical environment and is submitted to the highest certification standards because a bug can make the whole system crash.

Synchronous programming was introduced in the eighties to develop these software in a rigorous manner. It was the foundation of several languages and tools, in particular the language Lustre invented by Caspi and Halbwachs. Lustre introduced the idea that a dedicated programming language, manipulating infinite streams and stream functions would allow to express directly the mathematical models of control theory, to simulate and verify them, and to translate them into executable code. This idea, radical for the time, was imposed in the development of most critical software. For example, Scade, a direct descendent of Lustre, is now used routinely to develop the most critical control software in airplanes, for example.

Synchronous programming is a perfect example of the fruitful collaboration between engineering practice of control systems, pure and applied mathematics, informatics and the science of software.

In this talk, we will come back to the origin of Lustre, the link with the data-flow language Lucid and why synchrony was key for real-time programming. We will show some of the dedicated type systems that are incorporated in compilers like Scade to ensure important safety properties like determinacy and the ability to generate code that execute in bounded time and space. We will present some recent results, in particular the development of a formally verified Lustre compiler and the extension to deal with systems that mix discrete time and continuous time.

References

- [1] Timothy Bourke and Marc Pouzet. Zélus, a Synchronous Language with ODEs. In *International Conference on Hybrid Systems: Computation and Control (HSCC 2013)*, Philadelphia, USA, April 8–11 2013. ACM.
- [2] Albert Benveniste, Timothy Bourke, Benoit Caillaud, Bruno Pagano, and Marc Pouzet. A Type-based Analysis of Causality Loops in Hybrid Systems Modelers. In *International Conference on Hybrid Systems: Computation and Control (HSCC)*, Berlin, Germany, April 15–17 2014. ACM.
- [3] Timothy Bourke, Lélío Brun, Pierre-Évariste Dagand, Xavier Leroy, Marc Pouzet, and Lionel Rieg. A Formally Verified Compiler for Lustre. In *International Conference on Programming Language, Design and Implementation (PLDI)*, Barcelona, Spain, June 19-21 2017. ACM.
- [4] Timothy Bourke, Lélío Brun, and Marc Pouzet. Mechanized Semantics and Verified Compilation for a Dataflow Synchronous Language with Reset. In *International Conference on Principles of Programming Languages (POPL)*, New Orleans, Louisiana, United States, January 19-25 2020. ACM.

PARTITIONING SUBGROUPS OF THE SYMMETRIC GROUP $\mathfrak{S}(U)$

Norbert Sauer

Department of Mathematics and Statistics
University of Calgary
Alberta, Canada T2N 1N4
nsauer@ucalgary.ca

ABSTRACT

A relational structure U with U as set of vertices is *homogeneous* if every isomorphism of a finite induced substructure of U to a finite induced substructure of U extends to an automorphism of U . See [1]. The relational structure U is *indivisible* if for every colouring function $\gamma : U \rightarrow 2$ there exists an embedding f of U into U for which γ is constant on the image of f . It turns out that the property of being indivisible for a homogeneous relational structure U is a property of the action of the automorphism group of U . Giving rise to a theory of indivisible subgroups of the symmetric group of a countable infinite set U . In my talk for the ALGOS 2020 meeting and for the occasion of Maurice Pouzet's 75th birthday, I will discuss this situation as well as provide some results and their relation to the existing literature.

Keywords Groups acting on a countable infinite set · homogeneous structures · partition theory.

1 Embeddings, partitions, groups and homogeneous structures

Let U be a countable infinite set and let G be a subgroup of the symmetric group $\mathfrak{S}(U)$ of U . A function f of U into U is in the *closure of G relative to the pointwise-convergence topology* if for every finite subset F of U there exists a function $g \in G$ which agrees with the function f on the set F . Note that such a function f has to be an injection and will be called an *embedding of G* . A *copy* of the group G is the image of an embedding f of G . Then $g \in G$ to $f \circ g \circ f^{-1}$ is a group action isomorphism. The group G is *closed* if every bijection of U which is in the closure of G is an element of G . The *closure of G* is the group \overline{G} consisting of all embeddings of G which are bijections of U . The group G is *indivisible* if for every colouring function $\gamma : U \rightarrow 2$ there exists an embedding f of G into G for which γ is constant on the image of f . For details on the following facts see [2],[3] and [4]. The group G is closed if and only if there exists a homogeneous relational structure U on U whose automorphism group is G . The group G is indivisible if and only if its closure is indivisible. A function f is an embedding of G if and only if it is an embedding of the closure of G . If U is a homogeneous relational structure on U then f is an embedding of U if and only if it is an embedding of the automorphism group of U . The homogeneous structure U is indivisible if and only if the automorphism group of U is indivisible.

Investigating the indivisibility property of a subgroup G of $\mathfrak{S}(U)$ and related properties such as weak indivisibility, age indivisibility, Ramsey degrees, the structure of its copies as well as the cardinality of the twins of the homogeneous structures with automorphism group G goes well beyond classical group theory. See [3], [4], [5] and [6] for additional details. So far, those investigations do not seem to involve any classical group theory beyond elementary definitions. In this context the small index conjecture as well as the notions of EPPA and amalgamation should be mentioned. That is: Every subgroup of the automorphism group of the Rado graph of index less than continuum is open in the pointwise-convergence topology. See Hrushovsky [7] and for connections of those notions with Ramsey theory see [5]. For applications to topological dynamics see for example [8], [9] and [10].

In the talk, the notions for stating some results in the case of the automorphism groups of homogeneous structures of Henson type, see [11], will be introduced. In particular a necessary and sufficient condition for Henson type homogeneous structures to be indivisible will be discussed. See [4]. Special cases of Henson type homogeneous structures are

for example the Rado graph, the random triangle free homogeneous graph, the K_n -free random homogeneous graph and the random homogeneous partial order. It is not completely trivial, but does not require an extensive proof, to verify that the Rado graph is indivisible. Similarly the order structure η of the rationals is homogeneous. It is an interesting exercise to show that it is indivisible. The first deep result due to P. Komjáth and V. Rödl, see [12], stated that the random triangle free homogeneous graph is indivisible.

The action of the group G on the n -tuples of U produces again a subgroup of the symmetric group $\mathfrak{S}(U^n)$ of U^n . That is of a countable infinite set. Even if the subgroup G of $\mathfrak{S}(U)$ is of Henson type the action of G on U^2 is usually not of Henson type. Hence all of the notions of indivisibility etc. are much more difficult to analyse. For a result of this type in the case of the Rado graph see [13]. Using set theoretic methods Dobrinen obtained then a deep general result for the K_n -free random graphs, see [14]. See also [15].

References

- [1] Roland Fraïssé Theory of Relations, Revised Edition. In *Studies in Logic and the Foundations of Mathematics*, 145, North Holland 2000.
- [2] Peter J. Cameron Oligomorphic Permutation Groups. In *London Math. Soc. Lecture Notes* **152**, Cambridge Univ. Press, 1990.
- [3] Claude Laflamme, Maurice Pouzet, Norbert Sauer and Robert Woodrow. The poset of copies for automorphism groups of countable relational structures. Submitted to the Rosenberg Special Issue. It is available on *arXiv: arXiv:2002.04771v1 [math.CO]*.
- [4] Norbert Sauer Colouring homogeneous structures. In *arXiv: arXiv:2008.02375 [math.CO]*.
- [5] Jan Hubička, Jaroslav Nešetřil All those Ramsey classes. In *arXiv: arXiv: 1606.07979v4 [math.CO] 25 Jun 2016*.
- [6] Claude Laflamme, Maurice Pouzet, Norbert Sauer and Robert Woodrow Siblings of an \aleph_0 -categorical relational structure. Submitted to Banff proceedings, editor: Lionel Nguyen Van Thé. It is available on *arXiv: arXiv:1811.04185v2 [math.LO]*.
- [7] Ehud Hrushovski Extending partial isomorphisms of graphs. In *Combinatorica*, 12(4):411-416, 1992.
- [8] Andy Zucker Big Ramsey degrees and topological dynamics. In *Groups, Geometry and Dynamics (2018)*, 235-276.
- [9] Alexander S. Kechris, Vladimir G. Pestov, and Stevo Todorčević. Fraïssé limits, Ramsey theory, and topological dynamics of automorphism groups. In *Geometric and Functional Analysis*, 15(1):106=189, 2005
- [10] Lionel Nguyen Van Thé and Norbert Sauer The Urysohn Sphere is oscillation stable. In *Geometric and Functional Analysis, Volume 19, Issue 2 (2009)*, Page 536-557.
- [11] Ward Henson Countable homogeneous relational structures and \aleph_0 -categorical theories. In *Journal of Symbolic Logic*, (37), Issue 3 (1972), 494-500
- [12] Peter Komjáth, Vojtěch Rödl Coloring of universal graphs. In *Graphs and Combinatorics* **2**, Issue 1 (1986) 55-60.
- [13] Norbert Sauer Coloring subgraphs of the Rado graph. In *Combinatorica*, **26** (2), (2006), 231-253.
- [14] Natasha Dobrinen The Ramsey theory of Henson graphs. In *arXiv: 1901.06660v2 [math.CO] 27 Apr 2019*.
- [15] Denis Devlin Some partition theorems and ultrafilters on ω . In *PhD thesis, Dartmouth College, 1979*.

TWIN-WIDTH

Edouard Bonnet
ENS de Lyon

Colin Geniet
ENS de Cachan

EunJung Kim
Université Paris-Dauphine - PSL

Stéphan Thomassé
ENS de Lyon

Rémi Watrigant
ENS de Lyon

ABSTRACT

We generalize to binary structures a decomposition proposed by Sylvain Guillemot and Daniel Marx for permutations. We hence propose a measure of complexity, the twin-width of a graph. Twin-width interplays very nicely with topics popularized by Maurice Pouzet: decompositions based on homogeneous subsets, complexity of partial orders, free interpretation of relations, linear orders on vertices of relations, profile of ages, etc. We believe that many future connections can be established and hope that this talk will be the start of new developments.

1 Introduction

In 2014, Sylvain Guillemot and Daniel Marx proved that detecting a fixed permutation pattern S in a permutation P can be done in linear time $f(S) \cdot |P|$. When S is 12345, this amounts to detect a 5-terms increasing subsequence in P , but S can be much more tricky and many researchers believed before their proof that no $f(S)n^c$ algorithm could solve it for some fixed c . They invented for this a completely new (decomposition method / dynamic programming) technique, based on the classical treewidth trick: if P does not contain S , then it admits a decomposition on which we can indeed efficiently prove that P does not contain S . The engine of their method is the Marcus-Tardos theorem: if an $n \times n$ 01-matrix has $c \cdot n$ entries then there is an $f(c)$ partition of its columns $C_1, \dots, C_{f(c)}$ and rows $R_1, \dots, R_{f(c)}$, each C_i and R_j being consecutive subsets, such that every submatrix $C_i \times R_j$ contains a 1 entry (of course f goes to infinity).

Since their approach was reminiscent of tree-width (also, Marcus-Tardos is strikingly close to "large linear degree implies large clique minor"), they asked for an extension of their method to other structures. We exactly follow their tracks and propose the notion of twin-width of a graph (and more generally of a matrix). Here are some remarks:

1) Twin-width is easy to define, it corresponds to the maximum degree of errors one can make, starting from a graph G and iteratively contracting pairs of twins or near-twins (the sequence is called a twin-decomposition). For instance cographs are the graphs with twin width 0. More generally, bounded rank-width implies bounded twin-width.

2) A graph G has bounded twin-width k if and only if one can enumerate its vertices in such a way that its adjacency matrix A_G does not have a large partition of its columns $C_1, \dots, C_{g(k)}$ and rows $R_1, \dots, R_{g(k)}$ (all parts being consecutive) such that every submatrix $C_i \times R_j$ is neither vertical (same column vector repeated) nor horizontal (same row vector repeated).

3) Using 2), one can prove for instance that strict minor closed classes of graphs, posets with bounded size antichains, strict classes of dimension two posets, strict classes of permutation graphs, all have bounded twin-width. Here "class" means closed under induced subgraphs.

4) Bounded twin-width is very resilient to operations, like of course taking complement, but also taking squares. For instance the square of a planar graph (add edges when distance is at most 2) has bounded twin-width. Much more generally, any first-order interpretation of a bounded twin-width graph has bounded twin width. It follows that for instance map graphs, or interval graphs with bounded number of lengths have bounded twin-width.

5) First Order model checking is linear when we have the twin-decomposition. For instance deciding if G has diameter at most k , or domination number at most k , or an induced path of length k can be done in $f(d, k)n$ time where d is the twin width of G (again if we have a decomposition).

6) The class of graphs with twin-width at most d is small, i.e. there are $c^n \cdot n!$ such labeled graphs on the vertex set $1, \dots, n$. We conjecture that twin-width is exactly the right invariant to describe small classes, that is: a class is small iff its twin-width is bounded.

7) In view of 6), one can immediately derive that cubic graphs have unbounded twin-width. However, there are some (Bilu-Linial) cubic expanders with twin width at most 6, hence even for cubic graphs, the separation bounded/unbounded twin-width is unclear. In particular twin-width is an independent notion of nowhere dense.

